

-- STATE OF NORTH CAROLINA--
DEPARTMENT OF TRANSPORTATION
RALEIGH, N.C.

FINAL REQUEST FOR PROPOSALS
DESIGN-BUILD PROJECT



TIP I-5110, R-2413A & R-2413B

January 14, 2014

Includes Addendum No. 1 Dated January 14, 2014



VOID FOR BIDDING

DATE AND TIME OF TECHNICAL AND PRICE PROPOSAL SUBMISSION: **March 10, 2014 BY 4:00 PM**

DATE AND TIME OF PRICE PROPOSAL OPENING: **March 27, 2014 AT 2:00 PM**

CONTRACT ID: C 203433

WBS ELEMENT NOS. 42345.3.FS1, 42345.3.S2, and 34429.3.S8

FEDERAL-AID NO. NHF-0073(25)

COUNTY: Guilford

ROUTE NOS. Joseph M. Bryan Boulevard / US 220 / NC 68 (Future I-73)

MILES: 9.4

LOCATION: Future I-73 from the existing Joseph M. Bryan Boulevard (SR 2085) / Airport Parkway interchange to south of US 220 near the Haw River.

TYPE OF WORK: DESIGN-BUILD AS SPECIFIED IN THE SCOPE OF WORK
CONTAINED IN THE REQUEST FOR PROPOSALS

NOTICE:

ALL PROPOSERS SHALL COMPLY WITH ALL APPLICABLE LAWS REGULATING THE PRACTICE OF GENERAL CONTRACTING AS CONTAINED IN CHAPTER 87 OF THE GENERAL STATUTES OF NORTH CAROLINA WHICH REQUIRES THE PROPOSER TO BE LICENSED BY THE N.C. LICENSING BOARD FOR CONTRACTORS WHEN BIDDING ON ANY NON-FEDERAL AID PROJECT WHERE THE BID IS \$30,000 OR MORE, EXCEPT FOR CERTAIN SPECIALTY WORK AS DETERMINED BY THE LICENSING BOARD. PROPOSERS SHALL ALSO COMPLY WITH ALL OTHER APPLICABLE LAWS REGULATING THE PRACTICES OF ELECTRICAL, PLUMBING, HEATING AND AIR CONDITIONING AND REFRIGERATION CONTRACTING AS CONTAINED IN CHAPTER 87 OF THE GENERAL STATUTES OF NORTH CAROLINA. NOT WITHSTANDING THESE LIMITATIONS ON BIDDING, THE PROPOSER WHO IS AWARDED ANY PROJECT SHALL COMPLY WITH CHAPTER 87 OF THE GENERAL STATUTES OF NORTH CAROLINA FOR LICENSING REQUIREMENTS WITHIN 60 CALENDAR DAYS OF BID OPENING, REGARDLESS OF FUNDING SOURCES.

5% BID BOND OR BID DEPOSIT REQUIRED

**PROPOSAL FORM FOR THE CONSTRUCTION OF CONTRACT NO. C203433
IN GUILFORD COUNTY, NORTH CAROLINA**

Date _____ **20** _____

**DEPARTMENT OF TRANSPORTATION,
RALEIGH, NORTH CAROLINA**

The Design-Build Team herein acknowledges that it has carefully examined the location of the proposed work to be known as Contract No. C203433; has carefully examined the Final Request for Proposals (RFP) and all addendums thereto, specifications, special provisions, the form of contract, and the forms of contract payment bond and contract performance bonds, which are acknowledged to be part of the Contract; and thoroughly understands the stipulations, requirements and provisions. The undersigned Design-Build Team agrees to be bound upon their execution of the Contract and including any subsequent award to them by the Secretary of Transportation in accordance with this Contract to provide the necessary contract payment bond and contract performance bond within fourteen calendar days after the written notice of award is received by them.

The undersigned Design-Build Team further agrees to provide all necessary materials, machinery, implements, appliances, tools, labor, and other means of construction, except as otherwise noted, to perform all the work and required labor to design, construct and complete all the work necessary for State Highway Contract No. C203433 in Guilford County by no later than the dates(s) specified in the Final RFP or Technical Proposal, whichever is earlier, and in accordance with the requirements of the Engineer, the Final RFP and Addenda thereto, the *2012 Standard Specifications for Roads and Structures*, specifications prepared by the Department, the Technical Proposal prepared by the Design-Build Team, at the lump sum price(s) bid by the Design-Build Team in their Price Proposal.

The Design-Build Team shall provide signed and sealed documents prepared by the Design-Build Team, which specifications and plans show the details covering this project and adhere to the items noted above.

The Design-Build Team acknowledges that project documents furnished by the Department are preliminary and provided solely to assist the Design-Build Team in the development of the project design. Unless otherwise noted herein, the Department does not warrant or guarantee the sufficiency or accuracy of any information furnished by the Department.

The Department does not warrant or guarantee the sufficiency or accuracy of any investigations made, nor the interpretations made or opinions of the Department as to the type of materials and conditions to be encountered at the project site. The Design-Build Team is advised to make such independent investigations, as they deem necessary to satisfy their self as to conditions to be encountered on this project. The Design-Build Team shall have no claim for additional compensation or for an extension of contract time for any reason resulting from the actual conditions encountered at the site differing from those indicated in any of the information or documents furnished by the Department except as may be allowed under the provisions of the Standard Specifications.

Although the Department has furnished preliminary designs for this project, unless otherwise noted herein, the Design-Build Team shall assume full responsibility, including liability, for the

project design, including the use of portions of the Department design, modification of such design, or other designs as may be submitted by the Design-Build Team.

The Design-Build Team shall be fully and totally responsible for the accuracy and completeness of all work performed under this contract, and shall indemnify and hold the Department harmless for any additional costs and all claims against the Department or the State which may arise due to errors or omissions of the Department in furnishing the preliminary project designs and information, and of the Design-Build Team in performing the work.

The published volume entitled *North Carolina Department of Transportation, Raleigh, Standard Specifications for Roads and Structures, January 2012*, as well as, all design manuals, policy and procedures manuals, and AASHTO publications and guidelines referenced in the Request For Proposals, with all amendments and supplements thereto, are by reference, incorporated and made part of this contract; that, except as herein modified, all the design, construction and Construction Engineering Inspection included in this contract is to be done in accordance with the documents noted above and under the direction of the Engineer.

If the Design-Build Proposal is accepted and the award is made, the Technical Proposal submitted by the Design-Build Team is by reference, incorporated and made part of this contract. The contract is valid only when signed either by the Contract Officer or such other person as may be designated by the Secretary to sign for the Department of Transportation. The conditions and provisions herein cannot be changed except by written approval as allowed by the Request for Proposals.

Accompanying the Design-Build Proposal shall be a bid bond secured by a corporate surety, or certified check payable to the order of the Department of Transportation, for five percent of the total bid price, which deposit is to be forfeited as liquidated damages in case this bid is accepted and the Design-Build Team shall fail to provide the required payment and performance bonds with the Department of Transportation, under the condition of this proposal, within 14 calendar days after the written notice of award is received by them, as provided in the Standard Specifications; otherwise said deposit will be returned to the Design-Build Team.

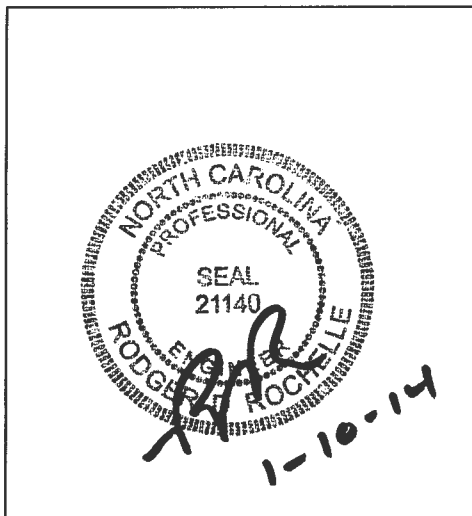

*Transportation Program
Management Director*

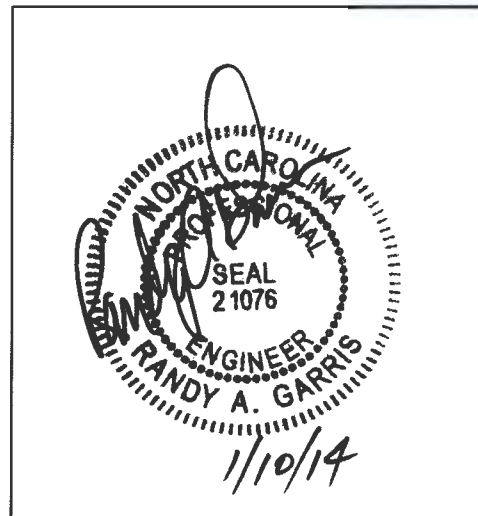

State Contract Officer

TABLE OF CONTENTS

COVER SHEET

PROPOSAL SHEETS

PROJECT SPECIAL PROVISIONS

PAGE NO.

Contract Time and Liquidated Damages	1
Intermediate Contract Time Number 1 and Liquidated Damages	1
Intermediate Contract Time Number 9 and Liquidated Damages	2
Other Liquidated Damages and Incentives	2
Funding Differentiation	3
Payout Schedule	4
Mobilization	4
Substantial Completion	5
Submittal of Quantities, Fuel Base Index Price and Opt-Out Option	5
Individual Meeting with Proposers	7
Execution of Bid, Non-Collusion Affidavit, Debarment Certification, and Gift Ban Certification	7
Submission of Design-Build Proposal	8
Alternative Technical Concepts and Confidential Questions	8
Value Analysis	13
Schedule of Estimated Completion Progress	13
Disadvantaged Business Enterprise	13
Certification for Federal-Aid Contracts	26
Contractor's License Requirements	27
U. S. Department of Transportation Hotline	27
Resource Conservation	27
Subsurface Information	28
Domestic Steel	28
Cooperation between Contractors	28
Bid Documentation	28
Twelve Month Guarantee	32
Erosion & Sediment Control / Storm Water Certification	33
Procedure for Monitoring Borrow Pit Discharge	38
FAA Notification of Construction	40
Clearing and Grubbing	40
Burning Restrictions	40
Building and Appurtenance Removal / Demolition	40
Pipe Installation	41
Reinforced Concrete Pipe Design	41
Drainage Pipe	43
Cement and Lime Stabilization of Sub-Grade Soils	43
Cement Treated Base Course	47
Price Adjustments for Asphalt Binder	49
Price Adjustments - Asphalt Concrete Plant Mix	49
Dynamic Message Sign	49

CCTV Field Equipment	86
Foundations and Anchor Rod Assemblies for Metal Poles	94
Overhead Sign Supports	100
Overhead and Dynamic Message Sign Foundations	107
Automated Machine Guidance	109
Log Cross Vane.....	110
Rock Cross Vane.....	111
Constructed Riffle.....	112
Rootwad	113
Rock A-Vane	114
Log Vane.....	114
Stream Plug.....	115
Log Sill.....	116
Natural Rock Energy Dissipater	117
Boulder Toe Protection	117
Structure Stone.....	118
Site Grading	119
Construction Surveying for Mitigation	119
Rock Vane.....	120
Pump Around Operation	121
Impervious Select Material	121
Contractor Requirements for Stream Relocations, Restorations, And Enhancements	122
Geotextile For Pavement Stabilization	123
GENERAL	125
SCOPES OF WORK	
Roadway	142
Pavement Management	152
Structures	158
Geotechnical Engineering	162
Hydraulics	172
GeoEnvironmental	176
Signing	178
Transportation Management	184
Utilities Coordination	201
ITS	209
Traffic Signals	217
Right of Way	224
Erosion and Sedimentation Control	229
Public Information	242
Environmental Permits	245
On-Site Mitigation	252
Lighting	256
Pavement Markings	257

PERMITS (TAN SHEETS)259

STANDARD SPECIAL PROVISIONS

Plant and Pest Quarantines 380
 Gifts from Vendors and Contractors 381
 State Highway Administrator Title Change 381
 Bridge Approach Fills 381
 Aggregate Stabilization 383
 Preparation of Subgrade and Base 385
 Asphalt Pavements – Superpave 385
 Asphalt Binder Content of Asphalt Plant Mixes 387
 Asphalt Plant Mixtures 388
 Final Surface Testing 388
 Open Graded Asphalt Friction Course, Permeable Asphalt Drainage Course,
 and Ultra-Thin Bonded Wearing Course 389
 Subsurface Drainage 391
 Guardrail Anchor Units, Type M-350 391
 Guardrail Anchor Units, Type 350 392
 Impact Attenuator Units, Type 350 393
 Preformed Scour Hole with Level Spreader Apron 395
 Street Signs and Markers and Route Markers 396
 Materials 396
 Select Material Class III Type 3 406
 Shoulder and Slope Borrow 406
 Temporary Shoring 407
 Truck Mounted Changeable Message Signs 418
 On-the-Job Training 419
 Sanitary Sewer 421
 Availability of Funds – Termination of Contracts 422
 NCDOT General Seed Specifications for Seed Quality 423
 Errata 426
 Award of Contract 428
 Minority and Female Employment Requirements 429
 Required Contract Provisions Federal-Aid Construction Contracts 432
 General Decision NC140092 01/03/2014 NC92 441
 Division One 445

PROPOSAL FORMS - ITEMIZED SHEET, ETC.

Itemized Proposal Sheet (TAN SHEET)
 Fuel Usage Factor Chart and Estimate of Quantities for I-5110
 Fuel Usage Factor Chart and Estimate of Quantities for R-2413A&B
 Fuel Usage Factor Chart and Estimate of Quantities for Taxiway Bridge
 Listing of DBE Subcontractors
 Execution of Bid, Non-Collusion Affidavit, Debarment Certification and Gift Ban Certification
 Signature Sheet

***** PROJECT SPECIAL PROVISIONS *****

CONTRACT TIME AND LIQUIDATED DAMAGES

07/12/07

DB1 G04A

The date of availability for this contract is **May 7, 2014** except that the Design-Build Team shall not begin ground disturbing activities, including utility relocations and tree harvesting, (this does not include permitted investigative borings covered under a Nationwide Permit No. 6 or utility relocations in upland areas) until a meeting is held between the NCDOT, the regulatory agencies and the Design-Build Team. Furthermore, no ground disturbing activities should occur on the I-5110 portion of the project unrelated to the construction of the taxiway bridge until the required permits for I-5110 have been acquired, as stipulated in the Environmental Permits Scope of Work contained elsewhere in this Request for Proposals (RFP). The Design-Build Team shall consider these factors in determining the proposed completion date for this project.

The completion date for this contract is defined as the date proposed in the Technical Proposal by the proposer who is awarded the project. The completion date thus proposed shall not be later than November 15, 2017.

When observation periods are required by the special provisions, they are not a part of the work to be completed by the completion date and/or intermediate contract times. Should an observation period extend beyond the final completion date, the acceptable completion of the observation period shall be a part of the work covered by the performance and payment bonds.

The liquidated damages for this contract are **Twenty Thousand Dollars (\$20,000.00)** per calendar day. As an exception to this amount, where the contract has been determined to be substantially complete as defined by the Special Provision entitled "Substantial Completion" found elsewhere in this RFP, the liquidated damages will be reduced to **Five Thousand Dollars (\$5000.00)** per calendar day.

Where the Design-Build Team who is awarded the contract has proposed a completion date for the contract as required above, but also has proposed an earlier date for substantial completion, then both of these proposed dates will become contract requirements.

Liquidated damages of **Twenty Thousand Dollars (\$20,000.00)** per calendar day will be applicable to the early date for substantial completion proposed by the bidder. Liquidated damages of **Five Thousand Dollars (\$5000.00)** per calendar day will be applicable to the final completion date proposed by the bidder where the Design-Build Team has proposed an earlier date for substantial completion.

INTERMEDIATE CONTRACT TIME NUMBER 1 AND LIQUIDATED DAMAGES

(3-22-07)

DB 1 G07

The Design-Build Team shall complete **all work to substantially complete I-5110**.

The date of availability for this intermediate contract time is the date of availability for this contract.

The completion date for this Intermediate Contract time #1 is defined as the date proposed in the Technical Proposal by the proposer who is awarded the project. The completion date thus proposed shall not be later than September 1, 2017.

The liquidated damages for this Intermediate Contract Time #1 are **Ten Thousand Dollars (\$10,000.00)** per calendar day or any portion thereof.

INTERMEDIATE CONTRACT TIME NUMBER 9 AND LIQUIDATED DAMAGES

(3-22-07)

DB 1 G07

The Design-Build Team shall complete all work to complete construction of the taxiway bridge over I-73 and a temporary connection to North Regional Road.

The date of availability for this intermediate contract time is the date of availability for this contract.

The completion date for this Intermediate Contract Time #9 is defined as the date proposed in the Technical Proposal by the proposer who is awarded the project. The completion date thus proposed shall not be later than December 31, 2016.

The liquidated damages for this Intermediate Contract Time #9 are **Two Thousand Five Hundred Dollars (\$2,500.00)** per calendar day or any portion thereof.

OTHER LIQUIDATED DAMAGES AND INCENTIVES

(3/22/07) (Rev. 02/14/08)

DB1 G11

Reference the Transportation Management Scope of Work for more information on the following time restrictions and liquidated damages:

Liquidated Damages for Intermediate Contract Time #2 for lane narrowing, lane closure, holiday and special event time restrictions for SR 2085 (Joseph M. Bryan Boulevard), NC 68, and SR 2133 (Pleasant Ridge Road), and SR 1541 (Wendover Ave.), including ramps and loops, are \$1,500.00 per hour or any portion thereof. Liquidated Damages for Intermediate Contract Time #2 for lane narrowing, lane closure, holiday and special event time restrictions for NC 150 (Oak Ridge Rd) are \$500.00 per hour or any portion thereof. Liquidated Damages for Intermediate Contract Time #2 for lane narrowing, lane closure, holiday and special event time restrictions for I-85, I-73, I-40, US 220, and US 421 are \$2500.00 per 15-minute period or any portion thereof.

Liquidated Damages for Intermediate Contract Time #3 for road closure time restrictions for installation of girders at SR 2085 (Joseph M. Bryan Boulevard) and NC 68, including ramps and loops, are \$1000.00 per 15-minute period or any portion thereof.

Liquidated Damages for Intermediate Contract Time #4 for road closure time restrictions for other certain construction operations at SR 2085 (Joseph M. Bryan Boulevard) and NC 68, including ramps and loops, are \$1000.00 per 15-minute period or any portion thereof. Liquidated Damages for Intermediate Contract Time #4 for road closure time restrictions for other certain construction operations on I-85, I-73, US 220, and US 421 are \$2500.00 per 15-minute period or any portion thereof.

Liquidated Damages for Intermediate Contract Time #5 for road closure time restrictions for SR 2133 (Pleasant Ridge Road), NC 150 (Oak Ridge Road), SR 2127 (Brookbank Road), SR 2128 (Bunch Road), and SR 2269 (Alcorn Road) are \$500.00 per 15-minute period or any portion thereof.

Liquidated Damages for Intermediate Contract Time #6 for road closure of (SR 2085) Joseph M. Bryan Blvd to NC 68 to complete the tie-in between existing and proposed SR 2085 extension to NC 68 are \$2,000.00 per calendar day or any portion thereof.

Liquidated Damages for Intermediate Contract Time #7 for the road closure time restrictions for certain construction operations on I-85 / I-73 / US 421 Southbound Lanes are \$2500.00 per 15-minute period or any portion thereof.

Reference the ITS Scope of Work for more information on the following time restriction and liquidated damages:

Liquidated Damages for Intermediate Contract Time #8 for failure to repair a damaged fiber optic communication cables and restore communication within 48 hours are \$500.00 per 48-hour period or any portion thereof.

Reference the Erosion and Sedimentation Control Scope of Work for additional information and additional Liquidated Damages:

The Design-Build Team will be eligible for an incentive in the amount of \$100,000.00 if construction operations have been performed in accordance with all environmental regulations and the Specifications, and the Design-Build Team does not receive any violations (ICA, CICA, NOV and / or C&D) at any time during project construction.

The Design-Build Team's first NOV or C&D violation shall result in the forfeiture of the entire \$100,000 incentive noted above or the remaining portion thereof. If \$25,000 is not available in the \$100,000 incentive noted above, the first NOV or C&D violation shall result in the forfeiture of the remaining portion plus Liquidated Damages in the amount necessary to equal \$25,000 when added to the remaining portion of the incentive. All subsequent NOV and C&D violations shall result in Liquidated Damages in the amount of \$25,000 per violation.

Each ICA and CICA violation shall result in a \$12,500 reduction from the monies remaining in the incentive. If monies are not available in the \$100,000 incentive noted above, each ICA and CICA violation shall result in Liquidated Damages in the amount of \$12,500 per violation.

FUNDING DIFFERENTIATION

The Itemized Proposal Sheet and the Cover sheet of this Request for Proposals identify three separate wbs elements each with a corresponding lump sum line item in the Itemized Proposal Sheet. The wbs elements and the work associated with each are as noted below;

34429.3.S8 All work required by this contract to complete the design and construction of R-2413A and R-2413B.

42345.3.FS1 All work required by this contract to complete the design and construction of I-5110 which expressly excludes the design and construction of the taxiway bridge.

42345.3.S2 All work required by this contract to complete the design and construction of the taxiway bridge.

A separate Table of Quantities and Schedule of Values will be required for each of these three line items and funding wbs elements (Reference the Division One Standard Special Provision found elsewhere in this RFP).

In the event that the lump sum price bid for Design and Construction Taxiway Bridge exceeds a threshold based on PTAA available funds, the Department, at the request of the Piedmont Triad Airport Authority, may elect to remove this work from the contract. Such election will occur after award of the contract but within 60 days of the opening of Price Proposals. Therefore, the election to remove or include the Design and Construction Taxiway Bridge work as part of this contract will have no bearing on the evaluation and determination of the Design-Build Team with the lowest Adjusted Price. In the event that this work is removed from this contract, no additional contract time or adjustment to the other line items in the Itemized Proposal Sheet will be made due to deletion of this work from the contract. In this event, no work shall be performed on the I-5110 project until all permits for I-5110 are obtained.

PAYOUT SCHEDULE

(11-16-09)

DB1 G13

No later than 12:00 o'clock noon on the sixth day after the opening of the Price Proposal, the responsive proposer with the lowest adjusted price shall submit a proposed Anticipated Monthly Payout Schedule to the office of the State Contract Officer. The information shall be submitted in a sealed package with the outer wrapping clearly marked "Anticipated Monthly Payout Schedule" along with the Design-Build Team name and the contract number. The Anticipated Monthly Payout Schedule will be used by the Department to establish the monthly funding levels for this project. The Anticipated Monthly Payout Schedule shall parallel, and agree with, the project schedule the Design-Build Team submits as a part of their Technical Proposal. The schedule shall include a monthly percentage breakdown (in terms of the total contract amount percentages) of the work anticipated to be completed. The schedule shall begin with the Date of Availability and end with the Actual Completion Date proposed by the Design-Build Team. If the Payout Schedule is not submitted as stated herein, the Technical and Price Proposals will be considered irregular by the Department, and the bid may be rejected.

Submit updates of the Anticipated Monthly Payout Schedule on March 15, June 15, September 15, and December 15 of each calendar year until project acceptance. Submit the all updates to the Resident Engineer with a copy to the State Construction Engineer at 1 South Wilmington St, 1543 Mail Service Center, Raleigh, NC 27699-1543.

MOBILIZATION

(9-1-11)

DB1 G15A

Revise the 2012 *Standard Specifications for Roads and Structures* as follows:

Page 8-1, Subarticle 800-2, MEASUREMENT AND PAYMENT

Delete this subarticle in its entirety and replace with the following:

800-2 MEASUREMENT AND PAYMENT

5 percent of the "Total Amount of Bid for Entire Project" shall be considered the lump sum amount for Mobilization. Partial payments for Mobilization will be made beginning with the first partial pay estimate paid on the contract. Payment will be made at the rate of 50 percent of the lump sum amount calculated for Mobilization. The remaining 50 percent will be paid with the second partial payment.

SUBSTANTIAL COMPLETION

(3-22-07)

DB1 G16

When the special provisions provide for a reduction in the rate of liquidated damages for the contract time or an intermediate contract time after the work is substantially complete, the work will be considered substantially complete when the following requirements are satisfied:

1. Through traffic has been placed along the project or along the work required by an intermediate contract time and the work is complete to the extent specified below, and all lanes and shoulders are open such that traffic can move unimpeded at the posted speed. Intersecting roads and service roads are complete to the extent that they provide the safe and convenient use of the facility by the public.
2. The final layers of pavement for all lanes and shoulders along the project or along the work required by an intermediate contract time are complete.
3. All signs are complete and accepted except for the signs on intersecting roadways.
4. All guardrails, drainage devices, ditches, excavation and embankment are complete.
5. Remaining work along the project consists of permanent pavement markings, permanent pavement markers or incidental construction that is away from the paved portion of the roadway.

Upon apparent substantial completion of the entire project or the work required by an intermediate contract time, the Engineer will make an inspection of the work. If the inspection discloses the entire project or the work required by an intermediate contract time is substantially complete; the Engineer will notify the Design-Build Team in writing that the work is substantially complete. If the inspection discloses the entire project or the work required by an intermediate contract time is not substantially complete, the Engineer will notify the Design-Build Team in writing of the work that is not substantially complete. The entire project or the work required by an intermediate contract time will not be considered substantially complete until all of the recommendations made at the time of the inspection have been satisfactorily completed.

SUBMITTAL OF QUANTITIES, FUEL BASE INDEX PRICE AND OPT-OUT OPTION

(06-08-11)

DB1 G43

(A) Submittal of Quantities

Submit quantities on the *Fuel Usage Factor Chart and Estimate of Quantities* sheets, located in the back of this RFP, following the Itemized Proposal Sheet. Each sheet corresponds to a Lump Sum Pay Item on the Itemized Proposal Sheet.

The Design-Build Team shall prepare Estimates of Quantities for those quantities that they anticipate incorporating into the completed project and upon which the Price Proposal was based. The quantity breakdown shall include all items of work that appear

in the *Fuel Usage Factor Chart and Estimate of Quantities* sheets. Only those items of work which are specifically noted in the Fuel Usage Factor Chart will be subject to fuel price adjustments. Fuel price adjustments will not apply to changes in these quantities resulting from a supplemental agreement.

Submittal The submittal shall be signed and dated by an officer of the Design-Build Team. The information shall be copied and submitted in a separate sealed package with the outer wrapping clearly marked “Fuel Price Adjustment” and shall be delivered at the same time and location as the Technical and Price Proposal. The original shall be submitted in the Price Proposal.

Trade Secret Information submitted on the *Fuel Usage Factor Chart and Estimate of Quantities* sheets will be considered “Trade Secret” in accordance with the requirements of G.S. 66-152(3) until such time as the Price Proposal is opened.

(B) Base Index Price

The Design-Build Team’s Estimate of Quantities will be used on the various partial payment estimates to determine fuel price adjustments. The Design-Build Team shall submit a payment request for quantities of work completed based on the work completed for that estimate period. The quantities requested for partial payment shall be reflective of the work actually accomplished for the specified period. The Design-Build Team shall certify that the quantities are reasonable for the specified period. The base index price for DIESEL #2 FUEL is **\$3.1407 per gallon**.

(C) Opt Out of Fuel Price Adjustment

If the Design-Build Team elects not to pursue reimbursement for Fuel Price Adjustments for the lump sum items on the Itemized Proposal Sheet, a quantity of zero shall be entered for all quantities in the *Fuel Usage Factor Chart and Estimate of Quantities* and the declination box shall be checked on all three *Fuel Usage Factor Chart and Estimate of Quantities* sheets. Failure to complete all of these forms will mean that the Design-Build Team is declining the Fuel Price Adjustments for the project.

(D) Change Option

The proposer will not be permitted to change the option after the Price Proposal and the copy of the *Fuel Usage Factor Chart and Estimate of Quantities* sheets are submitted.

(E) Failure to Submit

Failure to submit all three of the *completed Fuel Usage Factor Chart and Estimate of Quantities* sheets in a separate sealed package and in the Price Proposal will result in the Technical and Price Proposal being considered irregular by the Department and the Technical and Price Proposal may be rejected.

INDIVIDUAL MEETING WITH PROPOSERS

(9-1-11)

DB1 G048

The Department will provide at least two Question and Answer Sessions to meet with each proposer individually to specifically address questions regarding the draft Requests for Proposals.

The Department will attempt to arrange for a meeting between each individual proposer and the affected utility owners.

The Department will afford each proposer two additional meetings with the Department to discuss project specifics and address the proposers' concerns and questions. These meetings may occur at any time after the first Question and Answer Session with the proposers and before two weeks prior to the date of Technical and Price Proposals submission. The proposer shall request these meetings in writing to the State Contract Officer, providing the Department a minimum of one week advance notice of the requested date. The proposer shall also state in the request those disciplines within the Department that are requested to be in attendance. The Department makes no assurance that the request may be honored on that specific date or that all disciplines requested can be in attendance.

Additional individual meetings may be permitted in accordance with the *Alternative Technical Concepts and Confidential Questions* Project Special Provision found elsewhere in this RFP.

EXECUTION OF BID, NON-COLLUSION AFFIDAVIT, DEBARMENT CERTIFICATION AND GIFT BAN CERTIFICATION

(1/24/13)

DB1 G52

The Proposer's attention is directed to the various sheets in the Request for Proposals which are to be signed by the Proposer. A list of these sheets is shown below. The signature sheets are located behind the Itemized Proposal Sheet in this Request for Proposal. The NCDOT bid bond form is available on-line at:

<https://connect.ncdot.gov/letting/Pages/Design-Build-Resources.aspx>

or by contacting the Records and Documents office at 919-707-6900.

1. Applicable Signature Sheets: 1, 2, 3, 4, 5, or 6 (Bid)
2. Bid Bond dated the day of Technical and Price Proposal submission

The Proposer shall certify to the best of his knowledge all subcontractors, material suppliers and vendors utilized herein current status concerning suspension, debarment, voluntary exclusion, or determination of ineligibility by any federal agency, in accordance with the "Debarment Certification" located behind the *Execution of Bid Non-Collusion Affidavit, Debarment Certification and Gift Ban Certification* signature sheets in this RFP. Execution of the bid signature sheets in conjunction with any applicable statements concerning exceptions, when such statements have been made on the "Debarment Certification", constitutes the Proposer's certification of "status" under penalty of perjury under the laws of the United States.

SUBMISSION OF DESIGN-BUILD PROPOSAL

(9-1-11)

DB1 G55A

The Proposer's attention is directed that each Proposer's Design-Build Proposal shall comply with the following requirements in order for that Design-Build Proposal to be responsive and considered for award.

1. The Proposer shall be prequalified with the Department prior to submitting a Design-Build Proposal.
2. The Proposer shall deliver the Design-Build Proposal to the place indicated, and prior to the time indicated in this Request for Proposals.
3. The Design-Build Proposal documents shall be signed by an authorized employee of the Proposer.
4. The Design-Build Proposal shall be accompanied by Bid surety in the form of a Bid Bond or Bid Deposit, dated the day of Technical and Price Proposal submission.
5. If Disadvantaged Business Enterprises (DBE) goals are established for this contract, the Proposer shall complete the form Listing of DBE Subcontractors contained elsewhere in this RFP in accordance with the Project Special Provision entitled Disadvantaged Business Enterprises.
6. The Design-Build Proposal shall address all the requirements as specified in this Request for Proposals.

In addition to the above requirements, failure to comply with any of the requirements of Article 102-8 of the Standard Special Provisions, Division One (found elsewhere in this RFP), Article 102-9 of the 2012 *Standard Specifications for Roads and Structures*, or Article 102-10 of the 2012 *Standard Specifications for Roads and Structures* and as amended in the Standard Special Provisions, Division One (found elsewhere in this RFP) may result in a Design-Build Proposal being rejected.

ALTERNATIVE TECHNICAL CONCEPTS AND CONFIDENTIAL QUESTIONS

(06-08-11)

DB1 G56A

To accommodate innovation that may or may not be specifically allowed by the RFP, or other documents incorporated into the contract by reference, the Design-Build Team has the option of submitting Confidential Questions and Alternative Technical Concepts.

Definitions

A Confidential Question is defined as a private query to the Department containing information whose disclosure could alert others to certain details of doing business in a particular manner.

An Alternative Technical Concept is a private query to the Department that requests a variance to the requirements of the RFP, or other documents incorporated into the contract by reference,

that is equal or better in quality or effect as determined by the Department in its sole discretion and that have been used elsewhere under comparable circumstances.

Confidential Questions

The Design-Build Team will be permitted to ask Confidential Questions of the Department, and neither the question nor the answer will be shared with other Design-Build Teams. The Department, in its sole discretion, will determine if a question is considered confidential.

Confidential Questions arising prior to issuance of the Final RFP will be allowed during the industry review of the draft RFP with the individual Design-Build Teams. The Department will answer the Confidential Question verbally at the industry review meeting, if possible, and / or through subtle changes in the Final RFP, which will clarify the scope by either allowing or disallowing the request. To the greatest extent possible, the revision will be made in such a manner as to not disclose the Confidential Question.

After the issuance of the Final RFP, Confidential Questions may be asked by requesting a meeting with the State Contract Officer. The request shall be in writing and provide sufficient detail to evaluate the magnitude of the request. Questions shall be of such magnitude as to warrant a special meeting. Minor questions will not be acknowledged or answered. After evaluation, the State Contract Officer will respond to the question in writing to the Design-Build Team and / or through subtle changes in the Final RFP as reflected in an addendum, which will clarify the scope by either allowing or disallowing the request. To the greatest extent possible, the revision will be made in such a manner as to not disclose the Confidential Question.

If the Design-Build Team includes work based on the Confidential Questions and answers, the work shall be discussed in the Technical Proposal.

Alternative Technical Concepts

The Design-Build Team may include an ATC in the Technical and Price Proposal only if the ATC has been received by the Department by no later than three weeks prior to the deadline for submitting Technical and Price Proposals and it has been approved by the Department (including conditionally approved ATCs, if all conditions are met).

The submittal deadline above applies only to initial ATC submittals. Resubmittal of an ATC that (1) has been revised in response to the Department's requests for further information concerning a prior submittal or (2) is a Formal ATC for a Preliminary ATC that received a favorable response from the Department shall be received by the Department no later than one week prior to the deadline for submitting Technical and Price Proposals.

Should the Department revise the RFP after a Formal ATC has been approved, the Design-Build Team shall be solely responsible for reviewing the RFP and determining if the ATC deviates from the revised requirements. If necessary, the Design-Build Team must submit a request for approval of all additional required variance(s) within five business days of the revised RFP distribution.

An ATC shall in no way take advantage of an error or omission in the RFP, or other documents incorporated into the contract by reference. If, at the sole discretion of the Department, an ATC is deemed to take an advantage of an error or omission in the RFP, or other documents incorporated into the contract by reference, the RFP will be revised without regard to confidentiality. If at any time, the Department receives a documented question on the project similar to a concept submitted in the form of a Preliminary ATC or Formal ATC, the Department reserves the right to revise the RFP without further regard for confidentiality.

By approving an ATC, the Department acknowledges that the ATC may be included in the design and RFC plans; however, approval of any ATC in no way relieves the Design-Build Team of its obligation to satisfy (1) other contract requirements not specifically identified in the ATC submittal; (2) any obligation that may arise under applicable laws and regulations; and (3) any obligation mandated by the regulatory agencies as a permit condition.

ATC Submittals

Each ATC submittal shall include three individually bound hard copies and an electronic pdf file of the entire submittal and shall be submitted to the State Contract Officer at the address provided elsewhere in this RFP.

Formal ATCs

Each Formal ATC submittal shall include the following information:

- 1) Description. A detailed description and schematic drawings of the configuration of the ATC or other appropriate descriptive information (including, if appropriate, product details [i.e., specifications, construction tolerances, special provisions] and a traffic operational analysis, if appropriate);
- 2) Usage. Where and how the ATC would be used on the project;
- 3) Deviations. References to all requirements of the RFP, or other documents incorporated into the contract by reference, that are inconsistent with the proposed ATC, an explanation of the nature of the deviations from said requirements, and a request for approval of such variance(s);
- 4) Analysis. An analysis justifying use of the ATC and why the variance to the requirements of the RFP, or other documents incorporated into the contract by reference, should be allowed;
- 5) Impacts. Discussion of potential impacts on vehicular traffic, environmental impacts identified, community impact, safety and life-cycle project impacts, and infrastructure costs (including impacts on the cost of repair and maintenance);
- 6) History. A detailed description of other projects where the ATC has been used, the success of such usage, and names and telephone numbers of project owners that can confirm such statements;
- 7) Risks. A description of added risks to the Department and other entities associated with implementing the ATC; and
- 8) Costs. An estimate of the ATC implementation costs to the Department, the Design-Build Team, and other entities (right-of-way, utilities, mitigation, long term maintenance, etc.).

The Formal ATC, if approved, shall be included in the Price Proposal if the Design-Build Team elects to include it in their Technical Proposal.

Review of ATCs

A panel will be selected to review each ATC, which may or may not include members of the Technical Review Committee. The Design-Build Team shall make no direct contact with any member of the review panel, except as may be permitted by the State Contract Officer. Unapproved contact with any member of the review panel will result in a disqualification of that ATC.

The Department may request additional information regarding a proposed ATC at any time. To the greatest extent possible, the Department will return responses to, or request additional information from, the Design-Build Team within 15 business days of the original submittal of a Formal ATC. If additional information is requested, the Department will provide a response within 5 business days of receipt of all requested information.

The Department may conduct confidential one-on-one meeting(s) to discuss the Design-Build Team's ATC. Under no circumstances will the Department be responsible or liable to the Design-Build Team or any other party as a result of disclosing any ATC materials, whether the disclosure is deemed required by law, by an order of court, or occurs through inadvertence, mistake or negligence on the part of the Department or their respective officers, employees, contractors, or consultants.

In the event that the Department receives ATCs from more than one Design-Build Team that are deemed by the Department to be similar in nature, the Department reserves the right to modify the RFP without further regard for confidentiality.

The Department Response to Formal ATCs

The Department will review each Formal ATC and will respond to the Design-Build Team with one of the following determinations:

- 1) The ATC is approved;
- 2) The ATC is not approved;
- 3) The ATC is not approved in its present form, but may be approved upon satisfaction, in the Department's sole discretion, of certain identified conditions that shall be met or certain clarifications or modifications that shall be made (conditionally approved);
- 4) The submittal does not qualify as an ATC but may be included in the Proposal without an ATC (i.e., the concept complies with the baseline requirements of the RFP);
- 5) The submittal does not qualify as an ATC and may not be included in the Proposal;
- 6) The ATC is deemed to take advantage of an error or omission in the RFP, or other documents incorporated into the contract by reference, in which case the ATC will not be considered, and the RFP will be revised to correct the error or omission.

- 7) A documented question has been received outside of the ATC process on the same topic and the RFP will be revised to address that question; or
- 8) More than one ATC has been received on the same topic and the Department has elected to exercise its right to revise the RFP. This response could also follow and supersede one of the other previously supplied responses above.

Formal ATC Inclusion in Technical Proposal

The Design-Build Team may incorporate one or more approved Formal ATCs as part of its Technical and Price Proposals. If the Department responded to an Formal ATC by stating that it would be approved if certain conditions were met, those conditions shall be stipulated and met in the Technical Proposal.

In addition to outlining each implemented Formal ATC, and providing assurances to meet all attached conditions, The Design-Build Team shall also include a copy of the Formal ATC approval letter from the State Contract Officer in each of the twelve Technical Proposals submitted. This letter will be included in the distribution of the Technical Proposals to the Technical Review Committee.

Approval of an Formal ATC in no way implies that the Formal ATC will receive a favorable review from the Technical Review Committee. The Technical Proposals will be evaluated in regards to the evaluation criteria found in this RFP, regardless of whether or not Formal ATCs are included.

The Price Proposal shall reflect all incorporated Formal ATCs. Except for incorporating approved Formal ATCs, the Technical Proposal may not otherwise contain exceptions to, or deviations from, the requirements of the RFP, or other documents incorporated into the contract by reference.

Preliminary ATCs

At the Design-Build Team's option, a Preliminary ATC submittal may be made that presents a concept and a brief narrative of the benefits of said concept. The purpose of allowing such a Preliminary ATC is to limit the Design-Build Team's expense in the pursuit of a Formal ATC that may be quickly denied by the Department.

To the greatest extent possible, the Department will review Preliminary ATCs within 10 business days of submittal and provide written comments and one of the responses noted below. The Department's response to a Preliminary ATC submittal will be either (1) that the Preliminary ATC is denied; (2) that the Preliminary ATC would be considered as a Formal ATC if the Team so elects to pursue a Formal ATC submission; (3) that an ATC is not required; (4) a documented question has been received outside of the ATC process on the same topic and the RFP will be revised to address that question; or (5) that the ATC takes advantage of an error or omission in the RFP or other documents incorporated into the contract by reference, in which case the ATC will not be considered and the RFP will be revised to correct the error or omission. The Department in no way warrants that a favorable response to a Preliminary ATC submittal will

translate into a favorable response to a Formal ATC submittal. Likewise, a favorable response to a Preliminary ATC submittal is not sufficient to include the ATC in a Technical Proposal.

VALUE ANALYSIS

(9-1-11)

DB1 G57

Value Engineering Proposals, as specified in Article 104-12 of the 2012 *Standard Specifications for Roads and Structures* will be accepted. Only proposals, which alter the requirements of the RFP issued by the Department, will be considered as Value Engineering Proposals.

SCHEDULE OF ESTIMATED COMPLETION PROGRESS

(9-1-11)

DB1 G58

The Design-Build Team's attention is directed to the Standard Special Provision entitled "Availability of Funds - Termination of Contracts" included elsewhere in this RFP. The Department of Transportation's schedule of estimated completion progress for this project as required by that Standard Special Provision is as follows:

<u>Fiscal Year</u>	<u>Progress (Dollar Value)</u>
2014 (07/01/13 – 06/30/14)	7% of Total Amount Bid
2015 (07/01/14 – 06/30/15)	38% of Total Amount Bid
2016 (07/01/15 – 06/30/16)	30% of Total Amount Bid
2017 (07/01/16 – 06/30/17)	20% of Total Amount Bid
2018 (07/01/17 – 06/30/18)	5% of Total Amount Bid

The Design-Build Team shall also furnish its own progress schedule in accordance with Article 108-2 of the 2012 *Standard Specifications for Roads and Structures*. Any acceleration of the progress as shown by the Design-Build Team's progress schedule over the progress as shown above shall be subject to the approval of the Engineer.

DISADVANTAGED BUSINESS ENTERPRISE

(3/26/13)

DB1 G061

Description

The purpose of this Special Provision is to carry out the U.S. Department of Transportation's policy of ensuring nondiscrimination in the award and administration of contracts financed in whole or in part with Federal funds. This provision is guided by 49 CFR Part 26.

Definitions

Additional DBE Subcontractors - Any DBE submitted at the time of bid that will not be used to meet the DBE goal. No submittal of a Letter of Intent is required.

Committed DBE Subcontractor - Any DBE submitted at the time of bid that is being used to meet the DBE goal by submission of a Letter of Intent. Or any DBE used as a replacement for a previously committed DBE firm.

Contract Goal Requirement - The approved DBE participation at time of award, but not greater than the advertised contract goal.

DBE Goal - A portion of the total contract, expressed as a percentage, that is to be performed by committed DBE subcontractor(s).

Disadvantaged Business Enterprise (DBE) - A firm certified as a Disadvantaged Business Enterprise through the North Carolina Unified Certification Program.

Goal Confirmation Letter - Written documentation from the Department to the Proposer confirming the Design-Build Team's approved, committed DBE participation along with a listing of the committed DBE firms.

Manufacturer - A firm that operates or maintains a factory or establishment that produces on the premises, the materials or supplies obtained by the Design-Build Team.

Regular Dealer - A firm that owns, operates, or maintains a store, warehouse, or other establishment in which the materials or supplies required for the performance of the contract are bought, kept in stock, and regularly sold to the public in the usual course of business. A regular dealer engages in, as its principal business and in its own name, the purchase and sale or lease of the products in question. A regular dealer in such bulk items as steel, cement, gravel, stone, and petroleum products need not keep such products in stock, if it owns and operates distribution equipment for the products. Brokers and packagers are not regarded as manufacturers or regular dealers within the meaning of this section.

North Carolina Unified Certification Program (NCUCP) - A program that provides comprehensive services and information to applicants for DBE certification, such that an applicant is required to apply only once for a DBE certification that will be honored by all recipients of USDOT funds in the state and not limited to the Department of Transportation only. The Certification Program is in accordance with 49 CFR Part 26.

United States Department of Transportation (USDOT) - Federal agency responsible for issuing regulations (49 CFR Part 26) and official guidance for the DBE program.

Forms and Websites Referenced in this Provision

DBE Payment Tracking System - On-line system in which the Design-Build Team enters the payments made to DBE subcontractors who have performed work on the project.

<https://apps.dot.state.nc.us/Vendor/PaymentTracking/>

RF-1 *DBE Replacement Request Form* - Form for replacing a committed DBE.

<http://connect.ncdot.gov/projects/construction/Construction%20Forms/DBE%20MBE%20WBE%20Replacement%20Request%20Form.pdf>

SAF *Subcontract Approval Form* - Form required for approval to sublet the contract.

<http://connect.ncdot.gov/projects/construction/Construction%20Forms/Subcontract%20Approval%20Form%20Rev.%202012.zip>

JC-1 *Joint Check Notification Form* - Form and procedures for joint check notification. The form acts as a written joint check agreement among the parties providing full and prompt disclosure of the expected use of joint checks.

<http://connect.ncdot.gov/projects/construction/Construction%20Forms/Joint%20Check%20Notification%20Form.pdf>

Letter of Intent - Form signed by the Contractor and the DBE subcontractor, manufacturer or regular dealer that affirms that a portion of said contract is going to be performed by the signed DBE for the amount listed at the time of bid.

<http://connect.ncdot.gov/letting/LetCentral/Letter%20of%20Intent%20to%20Perform%20as%20a%20Subcontractor.pdf>

Listing of DBE Subcontractors Form - Form for entering DBE subcontractors on a project that will meet this DBE goal contained elsewhere in this RFP.

[http://connect.ncdot.gov/municipalities/Bid%20Proposals%20for%20LGA%20Content/08%20DBE%20Subcontractors%20\(Federal\).doc](http://connect.ncdot.gov/municipalities/Bid%20Proposals%20for%20LGA%20Content/08%20DBE%20Subcontractors%20(Federal).doc)

Subcontractor Quote Comparison Sheet - Spreadsheet for showing all subcontractor quotes in the work areas where DBEs quoted on the project. This sheet is submitted with good faith effort packages.

<http://connect.ncdot.gov/business/SmallBusiness/Documents/DBE%20Subcontractor%20Quote%20Comparison%20Example.xls>

DBE Goal

The following DBE goal for participation by Disadvantaged Business Enterprises is established for this contract:

Disadvantaged Business Enterprises **13.0 %**

- (A) *If the DBE goal is more than zero*, the Design-Build Team shall exercise all necessary and reasonable steps to ensure that DBEs participate in at least the percent of the contract as set forth above as the DBE goal.
- (B) *If the DBE goal is zero*, the Design-Build Team shall make an effort to recruit and use DBEs during the performance of the contract. Any DBE participation obtained shall be reported to the Department.

This goal is to be met through utilization of highway construction contractors and/or right-of-way acquisition firms. Utilization of DBE firms performing design or other preconstruction services are not included in this goal.

Directory of Transportation Firms (Directory)

Real-time information is available about firms doing business with the Department and firms that are certified through NCUCP in the Directory of Transportation Firms. Only firms identified in the Directory as DBE certified shall be used to meet the DBE goal. The Directory can be found at the following link.

<https://partner.ncdot.gov/VendorDirectory/default.html>

The listing of an individual firm in the directory shall not be construed as an endorsement of the firm's capability to perform certain work.

Listing of DBE Subcontractors

At the time of bid, Proposers shall submit all DBE participation that they anticipate to use during the life of the contract. Only those identified to meet the DBE goal will be considered committed, even though the listing shall include both committed DBE subcontractors and additional DBE subcontractors. Additional DBE subcontractor participation submitted at the time of bid will be used toward the Department's overall race-neutral goal. Only those firms with current DBE certification at the time of Price Proposal opening will be acceptable for listing in the Proposer's submittal of DBE participation. The Design-Build Team shall indicate the following required information:

**** NOTE **** Relocated Bullet regarding blank forms

- (1) *If the DBE goal is more than zero,*
 - (a) Proposers, at the time the Price Proposal is submitted, shall submit a listing of DBE participation, including the names and addresses on *Listing of DBE Subcontractors* contained elsewhere in the contract documents in order for the Price Proposal to be considered responsive. Proposers shall indicate the total dollar value of the DBE participation for the contract.
 - (b) If Proposers have no DBE participation, they shall indicate this on the *Listing of DBE Subcontractors* by entering the word "None" or the number "0." This form shall be completed in its entirety. **Blank forms will not be deemed to represent zero participation.** Price Proposals submitted that do not have DBE participation indicated on the appropriate form will not be read publicly during the opening of the Price Proposals. The Department will not consider these Price Proposals for award and the proposal will be rejected.
 - (c) The Proposer shall be responsible for ensuring that the DBE is certified at the time of bid by checking the Directory of Transportation Firms. If the firm is not certified at the time of the opening of the Price Proposals, that DBE's participation will not count towards achieving the DBE goal.

- (2) *If the DBE goal is zero*, entries on the Listing of DBE Subcontractors are not required for the zero goal, however any DBE participation that is achieved during the project shall be reported in accordance with requirements contained elsewhere in this RFP.

DBE Prime Contractor

When a certified DBE firm proposes on a contract that contains a DBE goal, the DBE firm is responsible for meeting the goal or making good faith efforts to meet the goal, just like any other proposer. In most cases, a DBE proposer on a contract will meet the DBE goal by virtue of the work it performs on the contract with its own forces. However, all the work that is performed by the DBE proposer and any other DBE subcontractors will count toward the DBE goal. The DBE proposer shall list itself along with any DBE subcontractors, if any, in order to receive credit toward the DBE goal.

For example, if the DBE goal is 45% and the DBE proposer will only perform 40% of the contract work, the prime will list itself at 40%, and the additional 5% shall be obtained through additional DBE participation with DBE subcontractors or documented through a good faith effort.

DBE prime contractors shall also follow Sections A and B listed under *Listing of DBE Subcontractor* just as a non-DBE proposer would.

Written Documentation – Letter of Intent

The Proposer shall submit written documentation for each DBE that will be used to meet the DBE goal of the contract, indicating the Proposer's commitment to use the DBE in the contract. This documentation shall be submitted on the Department's form titled *Letter of Intent*.

The documentation shall be received in the office of the State Contractor Utilization Engineer or at DBE@ncdot.gov no later than 12:00 noon of the sixth calendar day following opening of Price Proposals, unless the sixth day falls on an official state holiday. In that situation, it is due in the office of the State Contractor Utilization Engineer no later than 12:00 noon on the next official state business day.

If the Proposer fails to submit the Letter of Intent from each committed DBE to be used toward the DBE goal, or if the form is incomplete (i.e. both signatures are not present), the DBE participation will not count toward meeting the DBE goal. If the lack of this participation drops the commitment below the DBE goal, the Design-Build Team shall submit evidence of good faith efforts, completed in its entirety, to the State Contractor Utilization Engineer or DBE@ncdot.gov no later than 12:00 noon on the eighth calendar day following opening of the Price Proposals, unless the eighth day falls on an official state holiday. In that situation, it is due in the office of the State Contractor Utilization Engineer no later than 12:00 noon on the next official state business day.

Submission of Good Faith Effort

If the Proposer fails to meet or exceed the DBE goal the Proposer with the apparent adjusted low price shall submit to the Department documentation of adequate good faith efforts made to reach the DBE goal.

A hard copy and an electronic copy of this information shall be received in the office of the State Contractor Utilization Engineer or at DBE@ncdot.gov no later than 12:00 noon of the sixth calendar day following opening of the Price Proposals unless the sixth day falls on an official state holiday. In that situation, it is due in the office of the State Contractor Utilization Engineer the next official state business day. If the Design-Build Team cannot send the information electronically, then one complete set and 9 copies of this information shall be received under the same time constraints above.

Note: Where the information submitted includes repetitious solicitation letters, it will be acceptable to submit a representative letter along with a distribution list of the firms that were solicited. Documentation of DBE quotations shall be a part of the good faith effort submittal. This documentation may include written subcontractor quotations, telephone log notations of verbal quotations, or other types of quotation documentation.

Consideration of Good Faith Effort for Projects with DBE Goals More Than Zero

Adequate good faith efforts mean that the Proposer took all necessary and reasonable steps to achieve the goal which, by their scope, intensity, and appropriateness, could reasonably be expected to obtain sufficient DBE participation. Adequate good faith efforts also mean that the Proposer actively and aggressively sought DBE participation. Mere *pro forma* efforts are not considered good faith efforts.

The Department will consider the quality, quantity, and intensity of the different kinds of efforts a Proposer has made. Listed below are examples of the types of actions a proposer will take in making a good faith effort to meet the goal and are not intended to be exclusive or exhaustive, nor is it intended to be a mandatory checklist.

- (A) Soliciting through all reasonable and available means (e.g. attendance at pre-bid meetings, advertising, written notices, use of verifiable electronic means through the use of the NCDOT Directory of Transportation Firms) the interest of all certified DBEs who have the capability to perform the work of the contract. The Proposer must solicit this interest within at least 10 days prior to the opening of the Price Proposals to allow the DBEs to respond to the solicitation. Solicitation shall provide the opportunity to DBEs within the Division and surrounding Divisions where the project is located. The Proposer must determine with certainty if the DBEs are interested by taking appropriate steps to follow up initial solicitations.
- (B) Selecting portions of the work to be performed by DBEs in order to increase the likelihood that the DBE goals will be achieved. Where appropriate, break out contract work items into economically feasible units to facilitate DBE participation, even when the prime contractor might otherwise prefer to perform these work items with its own

forces. Negotiate with subcontractors to assume part of the responsibility to meet the contract DBE goal when the work to be sublet includes potential for DBE participation (2nd and 3rd tier subcontractors).

- (C) Providing interested DBEs with adequate information about the plans, specifications, and requirements of the contract in a timely manner to assist them in responding to a solicitation.
- (D)
 - (1) Negotiating in good faith with interested DBEs. It is the Proposer's responsibility to make a portion of the work available to DBE subcontractors and suppliers and to select those portions of the work or material needs consistent with the available DBE subcontractors and suppliers, so as to facilitate DBE participation. Evidence of such negotiation includes the names, addresses, and telephone numbers of DBEs that were considered; a description of the information provided regarding the plans and specifications for the work selected for subcontracting; and evidence as to why additional agreements could not be reached for DBEs to perform the work.
 - (2) A proposer using good business judgment would consider a number of factors in negotiating with subcontractors, including DBE subcontractors, and would take a firm's price and capabilities as well as contract goals into consideration. However, the fact that there may be some additional costs involved in finding and using DBEs is not in itself sufficient reason for a proposer's failure to meet the contract DBE goal, as long as such costs are reasonable. Also, the ability or desire of a prime contractor to perform the work of a contract with its own organization does not relieve the Proposer of the responsibility to make good faith efforts. Proposing Design-Build Teams are not, however, required to accept higher quotes from DBEs if the price difference is excessive or unreasonable.
- (E) Not rejecting DBEs as being unqualified without sound reasons based on a thorough investigation of their capabilities. The Proposer's standing within its industry, membership in specific groups, organizations, or associates and political or social affiliations (for example, union vs. non-union employee status) are not legitimate causes for the rejection or non-solicitation of bids in the Proposer's efforts to meet the project goal.
- (F) Making efforts to assist interested DBEs in obtaining bonding, lines of credit, or insurance as required by the recipient or proposer.
- (G) Making efforts to assist interested DBEs in obtaining necessary equipment, supplies, materials, or related assistance or services.
- (H) Effectively using the services of available minority/women community organizations; minority/women contractors' groups; Federal, State, and local minority/women business assistance offices; and other organizations as allowed on a case-by-case basis to provide assistance in the recruitment and placement of DBEs. Contact within 7 days from the opening of the Price Proposals the Business Development Manager in the Business

Opportunity and Work Force Development Unit to give notification of the Proposer's inability to get DBE quotes.

- (I) Any other evidence that the Proposer submits which shows that the Proposer has made reasonable good faith efforts to meet the DBE goal.

In addition, the Department may take into account the following:

- (1) Whether the Proposer's documentation reflects a clear and realistic plan for achieving the DBE goal.
- (2) The Proposer's past performance in meeting the DBE goals.
- (3) The performance of other proposers in meeting the DBE goal. For example, when the Proposer with the apparent adjusted low price fails to meet the DBE goal, but others meet it, you may reasonably raise the question of whether, with additional reasonable efforts the Proposer with the apparent adjusted low price could have met the goal. If the Proposer with the apparent adjusted low price fails to meet the DBE goal, but meets or exceeds the average DBE participation obtained by other proposers, the Department may view this, in conjunction with other factors, as evidence of the Proposer with the apparent adjusted low price having made a good faith effort.

If the Department does not award the contract to the Proposer with the apparent adjusted low price, the Department reserves the right to award the contract to the Proposer with the next adjusted lowest adjusted price that can satisfy to the Department that the DBE goal can be met or that an adequate good faith effort has been made to meet the DBE goal.

Non-Good Faith Appeal

The State Contractor Utilization Engineer will notify the Design-Build Team verbally and in writing of non-good faith. A Design-Build Team may appeal a determination of non-good faith made by the Goal Compliance Committee. If a Design-Build Team wishes to appeal the determination made by the Committee, they shall provide written notification to the State Contractual Services Engineer or at DBE@ncdot.gov. The appeal shall be made within 2 business days of notification of the determination of non-good faith.

Counting DBE Participation Toward Meeting DBE Goal

- (A) Participation

The total dollar value of the participation by a committed DBE will be counted toward the contract goal requirement. The total dollar value of participation by a committed DBE will be based upon the value of work actually performed by the DBE and the actual payments to DBE firms by the Design-Build Team.

(B) Joint Checks

Prior notification of joint check use shall be required when counting DBE participation for services or purchases that involves the use of a joint check. Notification shall be through submission of Form JC-1 (*Joint Check Notification Form*) and the use of joint checks shall be in accordance with the Department's Joint Check Procedures.

(C) Subcontracts (Non-Trucking)

A DBE may enter into subcontracts. Work that a DBE subcontracts to another DBE firm may be counted toward the contract goal requirement. Work that a DBE subcontracts to a non-DBE firm does not count toward the contract goal requirement. If a DBE contractor or subcontractor subcontracts a significantly greater portion of the work of the contract than would be expected on the basis of standard industry practices, it shall be presumed that the DBE is not performing a commercially useful function. The DBE may present evidence to rebut this presumption to the Department. The Department's decision on the rebuttal of this presumption is subject to review by the Federal Highway Administration but is not administratively appealable to USDOT.

(D) Joint Venture

When a DBE performs as a participant in a joint venture, the Design-Build Team may count toward its contract goal requirement a portion of the total value of participation with the DBE in the joint venture, that portion of the total dollar value being a distinct clearly defined portion of work that the DBE performs with its forces.

(E) Suppliers

A Design-Build Team may count toward its DBE requirement 60 percent of its expenditures for materials and supplies required to complete the contract and obtained from a DBE regular dealer and 100 percent of such expenditures from a DBE manufacturer.

(F) Manufacturers and Regular Dealers

A Design-Build Team may count toward its DBE requirement the following expenditures to DBE firms that are not manufacturers or regular dealers:

(1) The fees or commissions charged by a DBE firm for providing a *bona fide* service, such as providing bonds or insurance specifically required for the performance of a DOT-assisted contract, provided the fees or commissions are determined to be reasonable and not excessive as compared with fees and commissions customarily allowed for similar services.

(2) With respect to materials or supplies purchased from a DBE, which is neither a manufacturer nor a regular dealer, count the entire amount of fees or commissions charged for assistance in the procurement of the materials and

supplies, or fees or transportation charges for the delivery of materials or supplies required on a job site (but not the cost of the materials and supplies themselves), provided the fees are determined to be reasonable and not excessive as compared with fees customarily allowed for similar services.

Commercially Useful Function

(A) DBE Utilization

The Design-Build Team may count toward its contract goal requirement only expenditures to DBEs that perform a commercially useful function in the work of a contract. A DBE performs a commercially useful function when it is responsible for execution of the work of the contract and is carrying out its responsibilities by actually performing, managing, and supervising the work involved. To perform a commercially useful function, the DBE shall also be responsible with respect to materials and supplies used on the contract, for negotiating price, determining quality and quantity, ordering the material and installing (where applicable) and paying for the material itself. To determine whether a DBE is performing a commercially useful function, the Department will evaluate the amount of work subcontracted, industry practices, whether the amount the firm is to be paid under the contract is commensurate with the work it is actually performing and the DBE credit claimed for its performance of the work, and any other relevant factors.

(B) DBE Utilization in Trucking

The following factors will be used to determine if a DBE trucking firm is performing a commercially useful function.

- (1) The DBE shall be responsible for the management and supervision of the entire trucking operation for which it is responsible on a particular contract, and there shall not be a contrived arrangement for the purpose of meeting DBE goals.
- (2) The DBE shall itself own and operate at least one fully licensed, insured, and operational truck used on the contract.
- (3) The DBE receives credit for the total value of the transportation services it provides on the contract using trucks it owns, insures, and operates using drivers it employs.
- (4) The DBE may subcontract the work to another DBE firm, including an owner-operator who is certified as a DBE. The DBE who subcontracts work to another DBE receives credit for the total value of the transportation services the subcontracted DBE provides on the contract.
- (5) The DBE may also subcontract the work to a non-DBE firm, including from an owner-operator. The DBE who subcontracts the work to a non-DBE is entitled

to credit for the total value of transportation services provided by the non-DBE subcontractor not to exceed the value of transportation services provided by DBE-owned trucks on the contract. Additional participation by non-DBE subcontractors receives credit only for the fee or commission it receives as a result of the subcontract arrangement. The value of services performed under subcontract agreements between the DBE and the Design-Build Team will not count towards the DBE contract requirement.

- (6) A DBE may lease truck(s) from an established equipment leasing business open to the general public. The lease must indicate that the DBE has exclusive use of and control over the truck. This requirement does not preclude the leased truck from working for others during the term of the lease with the consent of the DBE, so long as the lease gives the DBE absolute priority for use of the leased truck. This type of lease may count toward the DBE's credit as long as the driver is under the DBE's payroll.
- (7) Subcontracted/leased trucks shall display clearly on the dashboard the name of the DBE that they are subcontracted/leased to and their own company name if it is not identified on the truck itself. Magnetic door signs are not permitted.

DBE Replacement

When a Design-Build Team has relied on a commitment to a DBE firm (or an approved substitute DBE firm) to meet all or part of a contract goal requirement, the Design-Build Team shall not terminate the DBE for convenience. This includes, but is not limited to, instances in which the Design-Build Team seeks to perform the work of the terminated subcontractor with another DBE subcontractor, a non-DBE subcontractor, or with the Contractor's own forces or those of an affiliate. A DBE may only be terminated after receiving the Engineer's written approval based upon a finding of good cause for the termination.

All requests for replacement of a committed DBE firm shall be submitted to the Engineer for approval on Form RF-1 (*DBE Replacement Request*). If the Design-Build Team fails to follow this procedure, the Prime Contractor or other affiliated companies within the Design-Build Team may be disqualified from further bidding for a period of up to 6 months.

The Design-Build Team shall comply with the following for replacement of a committed DBE:

(A) Performance Related Replacement

When a committed DBE is terminated for good cause as stated above, an additional DBE that was submitted at the time of bid may be used to fulfill the DBE commitment. A good faith effort will only be required for removing a committed DBE if there were no additional DBEs submitted at the time of bid to cover the same amount of work as the DBE that was terminated.

If a replacement DBE is not found that can perform at least the same amount of work as the terminated DBE, the Design-Build Team shall submit a good faith effort documenting the steps taken. Such documentation shall include, but not be limited to, the following:

- (1) Copies of written notification to DBEs that their interest is solicited in contracting the work defaulted by the previous DBE or in subcontracting other items of work in the contract.
 - (2) Efforts to negotiate with DBEs for specific subbids including, at a minimum:
 - (a) The names, addresses, and telephone numbers of DBEs who were contacted.
 - (b) A description of the information provided to DBEs regarding the plans and specifications for portions of the work to be performed.
 - (3) A list of reasons why DBE quotes were not accepted.
 - (4) Efforts made to assist the DBEs contacted, if needed, in obtaining bonding or insurance required by the Design-Build Team.
- (B) Decertification Replacement
- (1) When a committed DBE is decertified by the Department after the SAF (*Subcontract Approval Form*) has been received by the Department, the Department will not require the Design-Build Team to solicit replacement DBE participation equal to the remaining work to be performed by the decertified firm. The participation equal to the remaining work performed by the decertified firm will count toward the contract goal requirement.
 - (2) When a committed DBE is decertified prior to the Department receiving the SAF (*Subcontract Approval Form*) for the named DBE firm, the Design-Build Team shall take all necessary and reasonable steps to replace the DBE subcontractor with another DBE subcontractor to perform at least the same amount of work to meet the DBE goal requirement. If a DBE firm is not found to do the same amount of work, a good faith effort must be submitted to NCDOT (see A herein for required documentation).

Changes in the Work

When the Engineer makes changes that result in the reduction or elimination of work to be performed by a committed DBE, the Design-Build Team will not be required to seek additional participation. When the Engineer makes changes that result in additional work to be performed by a DBE based upon the Design-Build Team's commitment, the DBE shall participate in additional work to the same extent as the DBE participated in the original contract work.

When the Engineer makes changes that result in extra work, which has more than a minimal impact on the contract amount, the Design-Build Team shall seek additional participation by DBEs unless otherwise approved by the Engineer.

When the Engineer makes changes that result in an alteration of plans or details of construction, and a portion or all of the work had been expected to be performed by a committed DBE, the Design-Build Team shall seek participation by DBEs unless otherwise approved by the Engineer.

When the Design-Build Team requests changes in the work that result in the reduction or elimination of work that the Design-Build Team committed to be performed by a DBE, the Design-Build Team shall seek additional participation by DBEs equal to the reduced DBE participation caused by the changes.

Reports and Documentation

A SAF (*Subcontract Approval Form*) shall be submitted for all work which is to be performed by a DBE subcontractor. The Department reserves the right to require copies of actual subcontract agreements involving DBE subcontractors.

When using transportation services to meet the contract commitment, the Design-Build Team shall submit a proposed trucking plan in addition to the SAF. The plan shall be submitted prior to beginning construction on the project. The plan shall include the names of all trucking firms proposed for use, their certification type(s), the number of trucks owned by the firm, as well as the individual truck identification numbers, and the line item(s) being performed.

Within 30 calendar days of entering into an agreement with a DBE for materials, supplies or services, not otherwise documented by the SAF as specified above, the Design-Build Team shall furnish the Engineer a copy of the agreement. The documentation shall also indicate the percentage (60% or 100%) of expenditures claimed for DBE credit.

Reporting Disadvantaged Business Enterprise Participation

The Design-Build Team shall provide the Engineer with an accounting of payments made to all DBE firms, including material suppliers and contractors at all levels (prime, subcontractor, or second tier subcontractor). This accounting shall be furnished to the Engineer for any given month by the end of the following month. Failure to submit this information accordingly may result in the following action:

- (A) Withholding of money due in the next partial pay estimate; or
- (B) Removal of an approved Prime Contractor or other affiliated companies within the Design-Build Team from the prequalified bidders' list or the removal of other entities from the approved subcontractors list.

While each contractor (prime, subcontractor, 2nd tier subcontractor) is responsible for accurate accounting of payments to DBEs, it shall be the prime contractor's responsibility to report all monthly and final payment information in the correct reporting manner.

Failure on the part of the Design-Build Team to submit the required information in the time frame specified may result in the disqualification of that Prime Contractor and any affiliate companies within the Design-Build Team from further bidding until the required information is submitted.

Failure on the part of any subcontractor to submit the required information in the time frame specified may result in the disqualification of that Prime Contractor or any affiliate companies within the Design-Build Team from being approved for work on future DOT projects until the required information is submitted.

Design-Build Teams reporting transportation services provided by non-DBE lessees shall evaluate the value of services provided during the month of the reporting period only.

At any time, the Engineer can request written verification of subcontractor payments.

The Design-Build Team shall report the accounting of payments through the Department's DBE Payment Tracking System.

Failure to Meet Contract Requirements

Failure to meet contract requirements in accordance with Subarticle 102-15(J) of the 2012 *Standard Specifications for Roads and Structures* may be cause to disqualify the Prime Contractor or any affiliated companies within the Design-Build Team from further bidding for a specified length of time.

CERTIFICATION FOR FEDERAL-AID CONTRACTS

(3-21-90)

DB1 G85

The Proposer certifies, by signing and submitting a Design-Build Proposal, to the best of his or her knowledge and belief, that:

- (1) No Federal appropriated funds have been paid or will be paid, by or on behalf of the undersigned, to any person for influencing or attempting to influence an officer or employee of any Federal agency, a Member of Congress, an officer or employee of Congress, or an employee of a Member of Congress in connection with the awarding of any Federal contract, the making of any Federal grant, the making of any Federal loan, the entering into of any cooperative agreement, and the extension, continuation, renewal, amendment, or modification of any Federal contract, grant, loan, or cooperative agreement.
- (2) If any funds other than Federal appropriated funds have been paid or will be paid to any person for influencing or attempting to influence an officer or employee of any Federal agency, a Member of Congress, an officer or employee of Congress, or an employee of a Member of Congress in connection with this Federal contract, grant, loan, or cooperative agreement, the undersigned shall complete and submit Standard Form-LLL, *Disclosure Form to Report Lobbying*, in accordance with its instructions.

This certification is a material representation of fact upon which reliance was placed when this transaction was made or entered into. Submission of this certification is a prerequisite for making or entering into this transaction imposed by *Section 1352, Title 31, U.S. Code*. Any person who fails to file the required certification shall be subject to a civil penalty of not less than \$10,000 and not more than \$100,000 for each such failure.

The Proposer also agrees by submitting a Design-Build Proposal that he or she shall require that the language of this certification be included in all lower tier subcontracts, which exceed \$100,000 and that all such sub-recipients shall certify and disclose accordingly.

CONTRACTOR'S LICENSE REQUIREMENTS

(7-1-95)

DB1 G88

If the Design-Build Team does not hold the proper license to perform any plumbing, heating, air conditioning, or electrical work in this contract, he will be required to sublet such work to a contractor properly licensed in accordance with *Article 2 of Chapter 87 of the General Statutes* (licensing of heating, plumbing, and air conditioning contractors) and *Article 4 of Chapter 87 of the General Statutes* (licensing of electrical contractors).

U.S. DEPARTMENT OF TRANSPORTATION HOTLINE

(11-22-94)

DB1 G100

To report bid rigging activities call: **1-800-424-9071**

The U.S. Department of Transportation (DOT) operates the above toll-free *hotline* Monday through Friday, 8:00 a.m. to 5:00 p.m. eastern time. Anyone with knowledge of possible bid rigging, bidder collusion, or other fraudulent activities should use the *hotline* to report such activities.

The *hotline* is part of the DOT's continuing effort to identify and investigate highway construction contract fraud and abuse. It is operated under the direction of the DOT Inspector General. All information will be treated confidentially and caller anonymity will be respected.

RESOURCE CONSERVATION

(3/27/13)

104-13

DB1 G118

In accordance with North Carolina Executive Order 156, NCGS 130A-309.14(2), and NCGS 136-28.8, it is the policy of the Department to aid in the reduction of materials that become a part of our solid waste stream, to divert materials from landfills, and to find ways to recycle and reuse materials for the benefit of the Citizens of North Carolina.

Initiate, develop and use products and construction methods that incorporate the use of recycled or solid waste products in accordance with Article 104-13 of the *2012 Standard Specifications*. Report the quantities of reused or recycled materials either incorporated in the project or diverted from landfills on the Project Construction Reuse and Recycling Reporting Form.

A location-based tool for finding local recycling facilities and the Project Construction Reuse and Recycling Reporting Form are available at:

<http://connect.ncdot.gov/resources/Environmental/Pages/North-Carolina-Recycling-Locations.aspx>

SUBSURFACE INFORMATION

(3-22-07)

DB1 G119

Available subsurface information will be provided on this project. The Design-Build Team shall be responsible for additional investigations and for verifying the accuracy of the subsurface information supplied by the Department.

DOMESTIC STEEL

(3-6-13)

106

DB G 120

Revise the 2012 *Standard Specifications for Roads and Structures* as follows:

Page 1-49, Subarticle 106-1(B) Domestic Steel, lines 2-7, replace the first paragraph with the following:

All steel and iron products that are permanently incorporated into this project shall be produced in the United States except minimal amounts of foreign steel and iron products may be used provided the combined material cost of the items involved does not exceed 0.1% of the total amount bid for the entire project or \$2,500, whichever is greater, and that the contractor can provide invoices documenting the cost of the items. This minimal amount of foreign produced steel and iron products permitted for use is not applicable to high strength fasteners. Domestically produced high strength fasteners are required.

COOPERATION BETWEEN CONTRACTORS

(9-1-11)

DB1 G133

The Design-Build Team's attention is directed to Article 105-7 of the 2012 *Standard Specifications for Roads and Structures*.

Project R-2413C connects to the north end of R-2413B.

The Design-Build Team on this project shall cooperate with the Contractor(s) working within or adjacent to the limits of this project, to the extent that the work can be carried out to the best advantage of all concerned.

BID DOCUMENTATION

(Rev. 07-31-12)

DB1 G142

General

The successful Design-Build Team shall submit the original, unaltered bid documentation or a certified copy of the original, unaltered bid documentation used to prepare the Price Proposal for this contract to the Department within 10 days after receipt of notice of award of contract. Such documentation shall be placed in escrow with a banking institution or other bonded document storage facility selected by the Department.

The Department will not execute the contract until the original, unaltered bid documentation or a certified copy of the original, unaltered bid documentation has been received by the Department.

Terms

Bid Documentation – Bid Documentation shall mean all written information, working papers, computer printouts, electronic media, charts, and all other data compilations which contain or reflect information, data, and calculations used by the Proposer in the preparation of the Price Proposal. The term *bid documentation* includes, but is not limited to, Design-Build Team equipment rates, Design-Build Team overhead rates, labor rates, efficiency or productivity factors, arithmetical calculations, and quotations from subcontractors and material suppliers to the extent that such rates and quotations were used by the Proposer in formulating and determining the Price Proposal. The term *bid documentation* also includes any manuals, which are standard to the industry used by the Proposer in determining the Price Proposal. Such manuals may be included in the bid documentation by reference. Such reference shall include the name and date of the publication and the publisher. *Bid Documentation* does not include bid documents provided by the Department for use by the Proposer in bidding on this project.

Design-Build Team's Representative – Officer of the Prime Contractor's company; if not an officer, the Contractor shall supply a letter signed and notarized by an officer of the Prime Contractor's company, granting permission for the representative to sign the escrow agreement on behalf of the Prime Contractor.

Escrow Agent – Officer of the select banking institution or other bonded document storage facility authorized to receive and release bid documentation.

Escrow Agreement Information

A copy of the Escrow Agreement will be mailed to the Proposer with the notice of award for informational purposes. The Proposer and Department will sign the actual Escrow Agreement at the time the bid documentation is delivered to the escrow agent.

Failure to Provide Bid Documentation

The Proposer's failure to provide the original, unaltered bid documentation or a certified copy of the original, unaltered bid documentation within 10 days after the notice of award is received by him may be just cause for rescinding the award of the contract and may result in the removal of the Proposer from the Department's list of qualified bidders for a period of up to 180 days. Award may then be made to the Proposer with the next lowest adjusted price or the work may be readvertised and constructed under the contract or otherwise, as the Department may decide.

Submittal of Bid Documentation

(A) Appointment – Email specs@ncdot.gov or call 919.707.6900 to schedule an appointment.

- (B) Delivery - A representative of the Bidder shall deliver the original, unaltered bid documentation or a certified copy of the original, unaltered bid documentation to the Department, in a container suitable for sealing, within 10 days after the notice of award is received by him. Bid documentation will be considered a certified copy if the Bidder includes a letter to the Department from a chief officer of the company stating that the enclosed documentation is an *EXACT* copy of the original documentation. The letter shall be signed by a chief officer of the company, have the person's name and title typed below the signature, and the signature shall be notarized at the bottom of the letter.
- (C) Packaging – The container shall be no larger than 15.5 inches in length by 12 inches wide by 11 inches high and shall be water resistant. The container shall be clearly marked on the face and the back of the container with the following information: Bid Documentation, Bidder's Name, Bidder's Address, Date of Escrow Submittal, Contract Number, TIP Number if applicable, and County.

Affidavit

In addition to the bid documentation, an affidavit signed under oath by an individual authorized by the Proposer to execute the bid shall be included. The affidavit shall list each bid document with sufficient specificity so a comparison may be made between the list and the bid documentation to ensure that all of the bid documentation listed in the affidavit has been enclosed. The affidavit shall attest that the affiant has personally examined the bid documentation, that the affidavit lists all of the documents used by the Proposer to determine the Price Proposal for this project, and that all such bid documentation has been included.

Verification

Upon delivery of the bid documentation, the Department's Contract Officer and the Proposer's representative will verify the accuracy and completeness of the bid documentation compared to the affidavit. Should a discrepancy exist, the Proposer's representative shall immediately furnish the Department's Contract Officer with any other needed bid documentation. The Department's Contract Officer upon determining that the bid documentation is complete will, in the presence of the Proposer's representative, immediately place the complete bid documentation and affidavit in the container and seal it. Both parties will deliver the sealed container to the escrow agent for placement in a safety deposit box, vault, or other secure accommodation.

Confidentiality of Bid Documentation

The bid documentation and affidavit in escrow are, and will remain, the property of the Proposer. The Department has no interest in, or right to, the bid documentation and affidavit other than to verify the contents and legibility of the bid documentation unless the Design-Build Team gives written notice of intent to file a claim, files a written claim, files a written and verified claim, or initiates litigation against the Department. In the event of such written notice of intent to file a claim, filing of a written claim, filing a written and verified claim, or initiation of litigation against the Department, or receipt of a letter from the Design-Build Team authorizing release, the bid documentation and affidavit may become the property of the Department for use in considering any claim or in litigation as the Department may deem appropriate.

Any portion or portions of the bid documentation designated by the Proposer as a *trade secret* at the time the bid documentation is delivered to the Department's Contract Officer shall be protected from disclosure as provided by *G.S. 132-1.2*.

Duration and Use

The bid documentation and affidavit shall remain in escrow until 60 calendar days from the time the Contractor receives the final estimate; or until such time as the Design-Build Team:

- (A) Gives written notice of intent to file a claim,
- (B) Files a written claim,
- (C) Files a written and verified claim,
- (D) Initiates litigation against the Department related to the contract; or
- (E) Authorizes in writing its release.

Upon the giving of written notice of intent to file a claim, filing a written claim, filing a written and verified claim, or the initiation of litigation by the Design-Build Team against the Department, or receipt of a letter from the Design-Build Team authorizing release, the Department may obtain the release and custody of the bid documentation.

The Proposer certifies and agrees that the sealed container placed in escrow contains all of the bid documentation used to determine the Price Proposal and that no other bid documentation shall be relevant or material in litigation over claims brought by the Design-Build Team arising out of this contract.

Release of Bid Documentation to the Contractor

If the bid documentation remains in escrow 60 calendar days after the time the Design-Build Team receives the final estimate and the Design-Build Team has not filed a written claim, filed a written and verified claim, or has not initiated litigation against the Department related to the contract, the Department will instruct the escrow agent to release the sealed container to the Prime Contractor.

The Contractor will be notified by certified letter from the escrow agent that the bid documentation will be released to the Contractor. The Contractor or his representative shall retrieve the bid documentation from the escrow agent within 30 days of the receipt of the certified letter. If the Contractor does not receive the documents within 30 days of the receipt of the certified letter, the Department will contact the Contractor to determine final dispersion of the bid documentation.

Payment

The cost of the escrow will be borne by the Department. There will be no separate payment for all costs of compilation of the data, container, or verification of the bid documentation. Payment at the various contract unit or lump sum prices in the contract will be full compensation for all such costs.

TWELVE MONTH GUARANTEE

(7-15-03)

DB1 G145

- (A) The Design-Build Team shall guarantee materials and workmanship against latent and patent defects arising from faulty materials, faulty workmanship or negligence for a period of twelve months following the date of final acceptance of the work for maintenance and shall replace such defective materials and workmanship without cost to the Department. The Design-Build Team will not be responsible for damage due to normal wear and tear, for negligence on the part of the Department, and / or for use in excess of the design.
- (B) Where items of equipment or material carry a manufacturer's guarantee for any period in excess of twelve months, then the manufacturer's guarantee shall apply for that particular piece of equipment or material. The Department's first remedy shall be through the manufacturer although the Design-Build Team shall be responsible for invoking the warranted repair work with the manufacturer. The Design-Build Team's responsibility shall be limited to the term of the manufacturer's guarantee. NCDOT would be afforded the same warranty as provided by the Manufacturer.
- (C) The Design-Build Team shall be responsible for any and all remediation activities at the on-site stream and wetland mitigation sites for a period of twelve months following final acceptance of the project at no additional cost to the Department.

This guarantee provision shall be invoked only for major components of work in which the Design-Build Team would be wholly responsible for under the terms of the contract. Examples would include pavement structures, bridge components, on-site mitigation and sign structures. This provision will not be used as a mechanism to force the Design-Build Team to return to the project to make repairs or perform additional work that the Department would normally compensate the Design-Build Team for. In addition, routine maintenance activities (i.e. mowing grass, debris removal, ruts in earth shoulders,) are not parts of this guarantee.

Appropriate provisions of the payment and/or performance bonds shall cover this guarantee for the project. In addition, failure on the part of the responsible entity(ies) of the Design-Build Team to perform guarantee work within the terms of this provision shall be just cause to remove the responsible entity(ies) from the Department's corresponding prequalified list. The Design-Build Team will be removed for a minimum of 6 months and will be reinstated only after all work has been corrected and the Design-Build Team requests reinstatement in writing.

To ensure uniform application statewide the Division Engineer will forward details regarding the circumstances surrounding any proposed guarantee repairs to the Chief Engineer for review and approval prior to the work being performed.

EROSION & SEDIMENT CONTROL / STORMWATER CERTIFICATION

(1-16-07) (Rev 07-13-12)

DB1 G180

General

Schedule and conduct construction activities in a manner that will minimize soil erosion and the resulting sedimentation and turbidity of surface waters. Comply with the requirements herein regardless of whether or not a National Pollutant Discharge Elimination System (NPDES) permit for the work is required.

Establish a chain of responsibility for operations and subcontractors' operations to ensure that the *Erosion and Sediment Control / Stormwater Pollution Prevention Plan* is implemented and maintained over the life of the contract.

- (A) *Certified Supervisor* – Provide a certified Erosion and Sediment Control / Stormwater (E&SC/SW) Supervisor to manage the Design-Build Team and subcontractor(s) operations, ensure compliance with Federal, State and Local ordinances and regulations, and to manage the Quality Control Program.
- (B) *Certified Foreman* – Provide a certified, trained foreman for each construction operation that increases the potential for soil erosion or the possible sedimentation and turbidity of surface waters.
- (C) *Certified Installer* – Provide a certified installer to install or direct the installation for erosion or sediment / stormwater control practices.
- (D) *Certified Designer* – Provide a certified designer for the design of the erosion and sediment control / stormwater component of reclamation plans and, if applicable, for the design of the project erosion and sediment control / stormwater plan.

Roles and Responsibilities

- (A) *Certified Erosion and Sediment Control / Stormwater Supervisor* - The Certified Supervisor shall be Level II and responsible for ensuring the erosion and sediment control / stormwater plan is adequately implemented and maintained on the project and for conducting the quality control program. The Certified Supervisor shall be on the project within 24 hours notice from initial exposure of an erodible surface to the project's final acceptance. Perform the following duties:
 - (1) **Manage Operations** - Coordinate and schedule the work of subcontractors so that erosion and sediment control/stormwater measures are fully executed for each operation and in a timely manner over the duration of the contract.
 - (a) Oversee the work of subcontractors so that appropriate erosion and sediment control/stormwater preventive measures are conformed to at each stage of the work.
 - (b) Prepare the required National Pollutant Discharge Elimination System (NPDES) Inspection Record and submit to the Engineer.

- (c) Attend all weekly or monthly construction meetings to discuss the findings of the NPDES inspection and other related issues.
 - (d) Implement the erosion and sediment control / stormwater site plans requested.
 - (e) Provide any needed erosion and sediment control / stormwater practices for the Design-Build Team's temporary work not shown on the plans, such as, but not limited to work platforms, temporary construction, pumping operations, plant and storage yards, and cofferdams.
 - (f) Acquire applicable permits and comply with requirements for borrow pits, dewatering, and any temporary work conducted by the Design-Build Team in jurisdictional areas.
 - (g) Conduct all erosion and sediment control / stormwater work in a timely and workmanlike manner.
 - (h) Fully perform and install erosion and sediment control / stormwater work prior to any suspension of the work.
 - (i) Coordinate with Department, Federal, State and Local Regulatory agencies on resolution of erosion and sediment control / stormwater issues due to the Design-Build Team's operations.
 - (j) Ensure that proper cleanup occurs from vehicle tracking on paved surfaces and / or any location where sediment leaves the Right-of-Way.
 - (k) Have available a set of erosion and sediment control/stormwater plans that are initialed and include the installation date of Best Management Practices. These practices shall include temporary and permanent groundcover and be properly updated to reflect necessary plan and field changes for use and review by Department personnel as well as regulatory agencies.
- (2) Requirements set forth under the NPDES Permit – The Department's NPDES Stormwater permit (NCS000250) outlines certain objectives and management measures pertaining to construction activities. The permit references *NCG010000, General Permit to Discharge Stormwater* under the NPDES, and states that the Department shall incorporate the applicable requirements into its delegated Erosion and Sediment Control Program for construction activities disturbing one or more acres of land. The Department further incorporates these requirements on all contracted bridge and culvert work at jurisdictional waters, regardless of size. Some of the requirements are, but are not limited to:
- (a) Control project site waste to prevent contamination of surface or ground waters of the state, i.e. from equipment operations/maintenance construction materials, concrete washout, chemicals, litter, fuels, lubricants, coolants, hydraulic fluids, any other petroleum products, and sanitary waste.
 - (b) Inspect erosion and sediment control / stormwater devices and stormwater discharge outfalls at least once every 7 calendar days, twice weekly for construction related Federal Clean Water Act, Section 303(d) impaired streams with turbidity violations, and within 24 hours after a significant rainfall event of 0.5 inch that occurs within a 24-hour period.

- (c) Maintain an onsite rain gauge or use the Department's Multi-Sensor Precipitation Estimate website to maintain a daily record of rainfall amounts and dates.
 - (d) Maintain erosion and sediment control / stormwater inspection records for review by Department and Regulatory personnel upon request.
 - (e) Implement approved reclamation plans on all borrow pits, waste sites and staging areas.
 - (f) Maintain a log of turbidity test results as outlined in the Department's Procedure for Monitoring Borrow Pit Discharge.
 - (g) Provide secondary containment for bulk storage of liquid materials.
 - (h) Provide training for employees concerning general erosion and sediment control / stormwater awareness, the Department's NPDES Stormwater Permit NCS000250 requirements, and the applicable requirements of the *General Permit, NCG010000*.
 - (i) Report violations of the NPDES permit to the Engineer immediately who will notify the Division of Water Quality Regional Office within 24 hours of becoming aware of the violation.
- (3) Quality Control Program - Maintain a quality control program to control erosion, prevent sedimentation and follow provisions / conditions of permits. The quality control program shall:
- (a) Follow permit requirements related to the Design-Build Team and subcontractors' construction activities.
 - (b) Ensure that all operators and / or subcontractor(s) on site have the proper erosion and sediment control / stormwater certification.
 - (c) Notify the Engineer when the required certified erosion and sediment control / stormwater personnel are not available on the job site when needed.
 - (d) Conduct the inspections required by the NPDES permit.
 - (e) Take corrective actions in the proper timeframe as required by the NPDES permit for problem areas identified during the NPDES inspections.
 - (f) Incorporate erosion control into the work in a timely manner and stabilize disturbed areas with mulch / seed or vegetative cover on a section-by-section basis.
 - (g) Use flocculants approved by state regulatory authorities where appropriate and where required for turbidity and sedimentation reduction.
 - (h) Ensure proper installation and maintenance of temporary erosion and sediment control devices.
 - (i) Remove temporary erosion or sediment control devices when they are no longer necessary as agreed upon by the Engineer.
 - (j) The Design-Build Team's quality control and inspection procedures shall be subject to review by the Engineer. Maintain NPDES inspection records and make records available at all times for verification by the Engineer.

- (B) *Certified Foreman* - At least one Certified Foreman shall be onsite for each type of work listed herein during the respective construction activities to control erosion, prevent sedimentation and follow permit provisions:

- (1) Foreman in charge of grading activities
- (2) Foreman in charge of bridge or culvert construction over jurisdictional areas
- (3) Foreman in charge of utility activities

The Design-Build Team may request to use the same person as the Level II Supervisor and Level II Foreman. This person shall be onsite whenever construction activities as described above are taking place. This request shall be approved by the Engineer prior to work beginning.

The Design-Build Team may request to name a single Level II Foreman to oversee multiple construction activities on small bridge or culvert replacement projects. This request shall be approved by the Engineer prior to work beginning.

- (C) *Certified Installers* - Provide at least one onsite, Level I Certified Installer for each of the following erosion and sediment control / stormwater crew:

- (1) Seeding and Mulching
- (2) Temporary Seeding
- (3) Temporary Mulching
- (4) Sodding
- (5) Silt fence or other perimeter erosion / sediment control device installations
- (6) Erosion control blanket installation
- (7) Hydraulic tackifier installation
- (8) Turbidity curtain installation
- (9) Rock ditch check / sediment dam installation
- (10) Ditch liner / matting installation
- (11) Inlet protection
- (12) Riprap placement
- (13) Stormwater BMP installations (such as but not limited to level spreaders, retention / detention devices)
- (14) Pipe installations within jurisdictional areas

If a Level I *Certified Installer* is not onsite, the Design-Build Team may substitute a Level II Foreman for a Level I Installer, provided the Level II Foreman is not tasked to another crew requiring Level II Foreman oversight.

- (D) *Certified Designer* – Include the certification number of the Level III-B Certified Designer on the erosion and sediment control / stormwater component of all reclamation plans and if applicable, the certification number of the Level III-A Certified Designer on the design of the project erosion and sediment control / stormwater plan.

Preconstruction Meeting

Furnish the names of the *Certified Erosion and Sediment Control / Stormwater Supervisor, Certified Foremen, Certified Installers and Certified Designers* and notify the Engineer in writing of changes in certified personnel over the life of the contract within 2 days of change.

Ethical Responsibility

Any company performing work for the North Carolina Department of Transportation has the ethical responsibility to fully disclose any reprimand or dismissal of an employee resulting from improper testing or falsification of records.

Revocation or Suspension of Certification

Upon recommendation of the Chief Engineer to the certification entity, certification for Supervisor, Certified Foremen, Certified Installers and Certified Designer may be revoked or suspended with the issuance of an Immediate Corrective Action (ICA), Notice of Violation (NOV), or Cease and Desist Order for erosion and sediment control / stormwater related issues.

The Chief Engineer may recommend suspension or permanent revocation of such certification due to the following:

- (A) Failure to adequately perform the duties as defined within this certification provision
- (B) Issuance of an ICA, NOV or Cease and Desist Order
- (C) Failure to fully perform environmental commitments as detailed within the permit conditions and specifications
- (D) Demonstration of erroneous documentation or reporting techniques
- (E) Cheating or copying another candidate's work on an examination
- (F) Intentional falsification of records
- (G) Directing a subordinate under direct or indirect supervision to perform any of the above actions
- (H) Dismissal from a company for any of the above reasons
- (I) Suspension or revocation of one's certification by another entity

Suspension or revocation of a certification will be sent by certified mail to the certificant and the Corporate Head of the company that employs the certificant.

A certificant has the right to appeal any adverse action which results in suspension or permanent revocation of certification by responding, in writing, to the Chief Engineer within 10 calendar days after receiving notice of the proposed adverse action.

Chief Engineer
1536 Mail Service Center
Raleigh, NC 27699-1536

Failure to appeal within 10 calendar days will result in the proposed adverse action becoming effective on the date specified on the certified notice. Failure to appeal within the time specified will result in a waiver of all future appeal rights regarding the adverse action taken. The certificant will not be allowed to perform duties associated with the certification during the appeal process. The Chief Engineer will hear the appeal and make a decision within 7 days of hearing the appeal. The decision of the Chief Engineer will be final and will be made in writing to the certificant.

If a certification is temporarily suspended, the certificant shall pass any applicable written examination and any proficiency examination, at the conclusion of the specified suspension period, prior to having the certification reinstated.

Measurement and Payment

Certified Erosion and Sediment Control / Stormwater Supervisor, Certified Foremen, Certified Installers and Certified Designer will be incidental to the project for which no direct compensation will be made.

PROCEDURE FOR MONITORING BORROW PIT DISCHARGE

(1-22-2013)

DB1 G181

Water discharge from borrow pit sites shall not cause surface waters to exceed 50 NTUs (nephelometric turbidity unit) in streams not designated as trout waters and 10 NTUs in streams, lakes or reservoirs designated as trout waters. For lakes and reservoirs not designated as trout waters, the turbidity shall not exceed 25 NTUs. If the turbidity exceeds these levels due to natural background conditions, the existing turbidity level shall not be increased.

If during any operating day, the downstream water quality exceeds the standard, the Design-Build Team shall do all of the following:

- (A) Either cease discharge or modify the discharge volume or turbidity levels to bring the downstream turbidity levels into compliance, or
- (B) Evaluate the upstream conditions to determine if the exceedance of the standard is due to natural background conditions. If the background turbidity measurements exceed the standard, operation of the pit and discharge can continue as long as the stream turbidity levels are not increased due to the discharge.
- (C) Measure and record the turbidity test results (time, date and sampler) at all defined sampling locations 30 minutes after startup and at a minimum, one additional sampling of all sampling locations during that 24-hour period in which the borrow pit is discharging.
- (D) Notify DWQ within 24 hours of any stream turbidity standard exceedances that are not brought into compliance.

During the Environmental Assessment required by Article 230-4 of the 2012 *Standard Specifications for Roads and Structures*, the Design-Build Team shall define the point at which the discharge enters into the State's surface waters and the appropriate sampling locations.

Sampling locations shall include points upstream and downstream from the point at which the discharge enters these waters. Upstream sampling location shall be located so that it is not influenced by backwater conditions and represents natural background conditions. Downstream sampling location shall be located at the point where complete mixing of the discharge and receiving water has occurred.

The discharge shall be closely monitored when water from the dewatering activities is introduced into jurisdictional wetlands. Any time visible sedimentation (deposition of sediment) on the wetland surface is observed, the dewatering activity will be suspended until turbidity levels in the stilling basin can be reduced to a level where sediment deposition does not occur. Staining of wetland surfaces from suspended clay particles, occurring after evaporation or infiltration, does not constitute sedimentation. No activities shall occur in wetlands that adversely affect the functioning of a wetland. Visible sedimentation will be considered an indication of possible adverse impacts on wetland use.

The Engineer will perform independent turbidity tests on a random basis. These results will be maintained in a log within the project records. Records will include, at a minimum, turbidity test results, time, date and name of sampler. Should the Department's test results exceed those of the Design-Build Team's test results, an immediate test shall be performed jointly with the results superseding the previous test results of both the Department and the Design-Build Team.

To plan, design, construct, and maintain BMPs to address water quality standards, the Design-Build Team shall use the *NCDOT Turbidity Reduction Options for Borrow Pits Matrix*, available at the website noted below:

http://www.ncdot.gov/doh/operations/dp_chief_eng/roadside/fieldops/downloads/Files/TurbidityReductionOptionSheet.pdf

Tier I Methods include stilling basins which are standard compensatory BMPs. Other Tier I methods are noncompensatory and shall be used when needed to meet the stream turbidity standards. Tier II Methods are also noncompensatory and are options that may be needed for protection of rare or unique resources or where special environmental conditions exist at the site which have led to additional requirements being placed in the DWQ's 401 Certifications and approval letters, Isolated Wetland Permits, Riparian Buffer Authorization or a DOT Reclamation Plan's Environmental Assessment for the specific site. Should the Design-Build Team exhaust all Tier I Methods on a site exclusive of rare or unique resources or special environmental conditions, Tier II Methods may be required by regulators on a case by case basis per supplemental agreement.

The Design-Build Team may use cation exchange capacity (CEC) values from proposed site borings to plan and develop the Price Proposal for the project. CEC values exceeding 15 milliequivalents per 100 grams of soil may indicate a high potential for turbidity and should be avoided when dewatering into surface water is proposed.

No additional compensation for monitoring borrow pit discharge will be paid.

FAA NOTIFICATION OF CONSTRUCTION

The Design-Build Team shall adhere to the requirements of the FAA *Operational Safety On Airports During Construction* Advisory Circular and the Concord Airport Authority Safety Program. The Design-Build Team shall notify the Federal Aviation Administration (FAA) and the Piedmont Triad Airport Authority in writing sixty days prior to any construction activities on the project, at the following addresses:

FAA

Piedmont Triad Airport Authority

Jennifer M. Fuller, P.E.,
Airport Project Manager
NCDOT Division of Aviation
jmf Fuller@ncdot.gov
http://ncdot.org/aviation
Telephone: 919-840-0645

Kevin Baker, Executive Director
Piedmont Triad International Airport
P.O. Box 35445
Greensboro, NC 27425
Telephone: 336-665-5600

The Design-Build Team shall be responsible for all work and costs associated with the FAA forms and approvals required for construction of the project. This shall include, but is not limited to, preparation and submittal of forms 7460-1 and 7460-2. These forms, instructions and examples of previous DOT projects can be found at the website listed above.

CLEARING AND GRUBBING

(9-1-11)

DB2 R01

With the exception of areas with Permanent Utility Easements, perform clearing on this project to the limits established by Method "III" shown on Standard No. 200.03 of the 2012 *NCDOT Roadway Standard Drawings*. In areas with Permanent Utility Easements, clearing shall extend to the Right of Way limits.

BURNING RESTRICTIONS

(7-1-95)

DB2 R05

Open burning is not permitted on any portion of the right of way limits established for this project. The Design-Build Team shall not burn the clearing, grubbing or demolition debris designated for disposal and generated from the project at locations within the project limits, off the project limits or at any waste or borrow sites in Guilford County. The Design-Build Team shall dispose of the clearing, grubbing and demolition debris by means other than burning and in accordance with state and local rules and regulations.

BUILDING AND APPURTENANCE REMOVAL / DEMOLITION

(9-1-11)

DB2 R12A

The Department will be responsible for the demolition of all buildings and appurtenances on all parcels acquired by the Department as shown on the R-2413A and R-2413B Right of Way Plans provided by the Department. **Prior to the Date of Availability, the Department will demolish the buildings and appurtenances on Parcel 950.** The Department will also investigate and remove any hazardous materials from Parcel 975 such that the buildings and appurtenances are ready for demolition by the Design-Build Team no later than July 1, 2014.

The remainder of this special provision applies to any other parcels to the extent not specifically noted above.

Unless otherwise as agreed upon by the Department, seal all wells and remove or demolish all buildings and appurtenances, in their entirety, that are located either partially or completely within the project's right of way limits or are located outside the project's right of way limits but within property purchased as an uneconomical remnant in accordance with Sections 205, 210 and 215 of the 2012 *Standard Specifications for Roads and Structures*.

The Department will perform all assessment, removal and disposal of asbestos. Once the Design-Build Team has acquired a parcel and all buildings and appurtenances have been vacated, the Design-Build Team shall immediately notify the Division Right of Way Agent in writing. Upon receipt of the written notification, the Department then requires 60 days to assess and remove any asbestos prior to the Design-Build Team demolishing any building or appurtenance.

PIPE INSTALLATION

09/28/12

300

DB3 R01

Revise the 2012 *Standard Specifications for Roads and Structures* as follows:

Page 3-1, Article 300-2, Materials, line 23-24, replace sentence with:

Provide foundation conditioning geotextile in accordance with Section 1056 for Type 4 geotextile.

REINFORCED CONCRETE PIPE DESIGN

(9-1-11)

DB3 R006

Description

This work consists of the design and manufacture of reinforced concrete pipes which require fills greater than 40 feet and less than or equal to 80 feet.

Materials

(A) Design

When the design of a reinforced concrete pipe is required on the plans developed by the Design-Build Team, design the reinforced concrete pipe in accordance with the current edition of the AASHTO LRFD Bridge Design Specifications. Provide the diameter of pipe as indicated on the plans developed by the Design-Build Team and manufacture the pipe in accordance with ASTM C 1417. Provide a reinforced concrete pipe that meets the requirements of Section 1032-6, Section 1077 and any other applicable parts of the 2012 *Standard Specifications for Roads and Structures*.

The design of the reinforced concrete pipe shall be the Design-Build Team's responsibility and is subject to review, comments and approval. Submit two sets of detailed plans for review and acceptance. Include all details in the plans, including the

size and spacing of the required reinforcement necessary to fabricate the reinforced concrete pipe. Include checked design calculations for the reinforced concrete pipe. Have a North Carolina Registered Professional Engineer seal the plans and design calculations. After the plans are reviewed and, if necessary, all corrections made, submit one set of reproducible tracings on 22" x 34" sheets to become part of the plans developed by the Design-Build Team.

(B) Reinforced Concrete Pipe Sections

(1) Class

Reinforced concrete pipe sections manufactured in accordance with this Special Provision are designated by inside pipe diameter and design earth cover.

(2) Design Criteria

The design of the reinforced concrete pipe shall be in accordance with Article 12.10.4.2 "Direct Design Method" of the current edition of the AASHTO LRFD Bridge Design Specifications. The following assumptions shall be used in the design calculations:

NCDOT Criteria for Direct Design Method
Process and Material Factors
Radial Tension, $F_{rp}=1.0$
Shear Strength, $F_{vp}=1.0$
Design Concrete Strength - f'_c 5,000 psi < f'_c < 7,000 psi
Heger Pressure Distribution - Type 2 Installation
Vertical Arching Factor = 1.40
Horizontal Arching Factor = 0.40
Soil Unit Weight = 120 lb / ft ³
Depth of Fluid = Inside Pipe Diameter
Minimum Concrete Cover = 1.00"
Crack Control = 0.90 (maximum)

(C) Joints

Produce the reinforced concrete pipe sections with spigot and bell ends. Design and form the ends of the pipe section so, when the sections are laid together, they make a continuous line of pipe with a smooth interior free of appreciable irregularities in the flow line, and compatible with the permissible variations given in the 2012 *Standard Specifications for Roads and Structures* and ASTM C 1417.

(D) Manufacture

In addition to the requirements of the 2012 *Standard Specifications for Roads and Structures* and ASTM C 1417, devices or holes are permitted in each pipe section for the purpose of handling and placement. Submit details of handling devices or holes for approval and do not cast any concrete until approval is granted. Remove all handling

devices flush with concrete surfaces as directed. Fill holes in a neat and workmanlike manner with an approved non-metallic non-shrink grout, concrete or plug.

DRAINAGE PIPE

(9-1-11)

DB3 R36

Description

Where shown in the plans developed by the Design-Build Team, the Contractor shall use Reinforced Concrete Pipe, Corrugated Aluminum Alloy Pipe, Aluminized Corrugated Steel Pipe, Corrugated Polyethylene Pipe (HDPE Pipe) or Polyvinyl-Chloride Pipe (PVC Pipe) in accordance with the following requirements:

All pipe types are subject to the maximum and minimum fill height requirements as found on Roadway Standard Drawing 300.01 - Sheet 3 of 3. The appropriate Reinforced Concrete Pipe class and the appropriate gage thickness for Corrugated Aluminum Alloy Pipe and Aluminized Corrugated Steel Pipe shall be selected based on fill height.

Site specific conditions may limit a particular material beyond what is identified in this Special Provision. These conditions include, but are not limited to, abrasion, environmental, soil resistivity and pH, high ground water and special loading conditions. The Design-Build Team shall determine if additional restrictions are necessary.

Slope drains shall be Corrugated Aluminum Alloy Pipe, Aluminized Corrugated Steel Pipe, Corrugated Polyethylene Pipe (HDPE Pipe) or Polyvinyl-Chloride Pipe (PVC Pipe).

Transverse median drains, storm drainage system pipes, and open-ended cross drains shall be Reinforced Concrete Pipe unless the pipe slope is greater than 10%, in which case the pipe shall be either Corrugated Aluminum Alloy Pipe or Aluminized Corrugated Steel Pipe.

CEMENT AND LIME STABILIZATION OF SUB-GRADE SOILS

(5-20-13)

DB5 R21

General

The Design-Build Team shall be responsible for the following:

1. Performing all laboratory tests in a laboratory certified by the AMRL / NCDOT Laboratory Proficiency Program
2. Sampling Sub-grade soils
3. Conducting Laboratory tests to determine:
 - a. Soil classifications
 - b. Moisture-density relationships
 - c. Quantity of lime or cement required to achieve specified strengths
4. Designating areas to be stabilized by either lime or cement and the required rates of application
5. Conducting field tests to determine unconfined compressive strength

Sampling

The Design-Build Team shall take soil samples, after the project has been graded to within 2 inches of final sub-grade elevation. The Design-Build Team shall sample the top 8 inches at a minimum frequency of one sample per 1,000 feet, per each lane, for classification tests; and one sample per 3,000 feet, per each lane, for moisture density tests and lime or cement mix design tests. For the aforementioned tests, a lane shall be considered 28 feet wide in one direction for sampling purposes. Additional samples shall be taken to ensure that all the predominant soil types, limits of distribution of these soils and different site conditions have been represented.

Classification Tests

The Design-Build Team shall perform the following tests to determine AASHTO classifications of different soils in accordance with AASHTO specifications as modified by NCDOT. Copies of these modified procedures can be obtained from Materials and Test Unit’s Soils Laboratory.

TABLE 1

<u>TEST</u>	<u>AASHTO DESIGNATION</u>
Dry Preparation of Disturbed Soils	T-87
Particle Size Analysis of Soils	T-88
Determining the Liquid Limit of Soils	T-89
Determining the Plastic Limit and Plasticity Index of Soils	T-90

Moisture Density Test

Based on the criteria set in Table 2, below, the Design-Build Team shall perform the Moisture Density Tests, using either lime or cement. The Design-Build Team shall use 10% cement by weight in soil cement and 4% lime by weight, in soil-lime mixtures. The Design-Build Team shall conduct the tests in accordance with AASHTO T-99, and T-134 for soil-lime and soil-cement mixtures, respectively. In each case, The Design-Build Team shall determine the maximum dry density and optimum moisture content.

TABLE 2

<u>CRITERIA FOR SELECTING LIME OR CEMENT</u>		
PROPERTY	A	B
Percent passing #200 Sieve	35 Max	36 Min
Liquid Limit	40 Max	41 Min
Plasticity Index	10 Max	25 Min

The Design-Build Team shall use cement for all soils meeting criteria in Column A and lime for all soils meeting criteria in Column B. The Design-Build Team may choose either lime or cement for all soils not meeting all criteria in either Column A or B.

DETERMINING THE APPLICATION RATES FOR SOIL-CEMENT AND SOIL-LIME MIXTURES

Soil-Cement Mixtures

For soil-cement mixtures, the Design-Build Team shall be required to do the following:

- Make specimens at optimum moisture content using a quantity of cement in the range of 5 to 12 percent by weight.
- Compact the specimens to a minimum density of 95% of maximum dry density obtained using AASHTO T 134.
- Make a minimum of 2 specimens for each selected cement rate.
- Cure the specimens for 7 days in a moist room maintained at a temperature of 73°F ±2.7° and a humidity of 100%. At the end of the curing period, immerse the specimens in water for 4 hours.
- After immersion, test the specimens in unconfined compression in accordance with ASTM D 1633.
- Report the maximum strength obtained and the corresponding percent strain.
- Select the rate of cement that provides a minimum unconfined compressive strength of 200 psi and a maximum of 400 psi.

Soil-Lime Mixtures

For soil-lime mixtures, the Design-Build Team shall be required to do the following:

- Make specimens at optimum moisture content using a quantity of lime in the range of 3.5 to 6.5 percent by weight.
- Compact specimens to a minimum density of 95% of maximum dry density obtained by AASHTO T99.
- Make a minimum of two specimens for each selected lime rate.
- Cure the specimens in sealed plastic bags for 48 hours in an oven at a temperature of 118 °F. Do not immerse the specimens in water at the end of the curing period.

- Test the specimens in unconfined compression in accordance with AASHTO T 208. Report the maximum strength obtained and the corresponding percent strain.
- Select the rate of lime that provides a minimum unconfined compressive strength of 60 psi.

Submittals for Review and Approval Prior to Construction

The Design-Build Team shall adhere to the following submittal guidelines:

- Submit all laboratory test results for review.
- Submit a sketch in plan view showing areas of the project to be stabilized by either lime or cement and application rates for each stabilizer.
- Submit any other documentation that supports the Design-Build Team's recommendations.

Construction of Lime Treated Subgrade

The Design-Build Team shall construct the lime treated sub-grade as specified in Section 501 of the North Carolina Department of Transportation *2012 Standard Specifications for Roads and Structures* with the following exceptions:

Subsection 501-4 Equipment

Contractor's equipment will not require engineer's approval.

Subsection 501-8 (A) General

Paragraph #1 is not applicable to this project.

Subsection 501-9 (B) Preliminary Curing

Amend as follows: Allow a minimum of 2 days and a maximum of 4 days for preliminary curing.

Subsection 501-10 Compacting, Shaping, and Finishing

Last paragraph is not applicable.

Subsection 501-11 Thickness

Last two paragraphs are not applicable.

Construction of Cement Treated Subgrade

The Design-Build Team shall construct the soil cement sub-grade as specified in section 542 of the *2012 Standard Specifications for Roads and Structures*, with the following exceptions:

Subsection 542-4 Equipment

Contractor's equipment will not require Engineer's approval.

Subsection 542-7 Application of Cement

First paragraph is not applicable.

Subsection 542-11 Thickness

Paragraphs 2 and 3 are not applicable.

Unconfined Compressive Strength

The lime-stabilized subgrades shall be tested using Dynamic Cone Penetrometer (DCP) and/or by making field specimens. DCP testing shall be in accordance with *Quality Assurance Testing of Lime-Treated Soils Utilizing the Dynamic Cone Penetrometer*, Test Method #1-2005. The Design-Build Team shall adhere to the testing equipment requirements and procedures as outlined in *Dynamic Cone Penetrometer Testing for Subgrade Stability* except that the minimum penetration depth shall be eight inches. Upon request, a copy of the aforementioned documents can be obtained from the NCDOT Geotechnical Engineering Unit. The required unconfined compressive strength for lime shall be 60 psi, which corresponds to a penetration per blow of approximately 0.5 inches of the Dynamic Cone Penetrometer. If field specimens are made, cure them for seven days and test them in the laboratory. The minimum required unconfined compressive strength for lime-stabilized subgrade shall be 60 psi.

For cement-stabilized subgrades, the Design-Build Team shall make field specimens, cure them for seven days and test them in the laboratory. The minimum and maximum required unconfined compressive strength for soil cement shall be 200 psi and 400 psi, respectively.

For both lime and cement stabilized subgrades, one test shall be required for every 400 feet per lane width at random locations selected using random number tables.

Submittals for Review During Construction

The Design-Build Team shall submit the unconfined compressive strength and dynamic cone penetrometer test results for review and acceptance.

CEMENT TREATED BASE COURSE

(07/22/2013)

DB5 R21A

General

The Design-Build Team shall be responsible for the following:

1. Performing all laboratory tests in a laboratory certified by the AMRL / NCDOT Laboratory Proficiency Program
2. Sampling Aggregate
3. Conducting Laboratory tests to determine:
 - a. Job Mix Formula
 - b. Quantity of cement required to achieve specified strengths
4. Designating areas to be stabilized by cement treated base course and the required rates of application
5. Conducting field tests to determine unconfined compressive strength

Sampling Aggregate

Aggregate shall be sampled from the proposed aggregate pile at the quarry. An AASHTO classification test with unit weight and optimum moisture determination shall be completed on the sample. The aggregate shall meet the Acceptance Criteria in Column B of Table 1010-4 of the NCDOT Aggregate Sampling Manual.

Job Mix Formula

A job mix formula shall be established for the accepted aggregate three weeks prior to proposed production. During production, the aggregate shall meet the tolerances specified in Table 540-1 of the 2012 *Standard Specifications for Roads and Structures*.

Determine Required Portland Cement Rate

The quantity of Portland cement required is 3.0 – 4.0 percent by weight of the aggregate. Mix 3.5% and 4.0% Portland cement, aggregate and water at 1.5% over optimum and cure for seven days. Select rate of cement that provides a minimum and maximum unconfined compressive strength of 500 psi and 800 psi at seven days, respectively.

Submittals for Review and Approval Prior to Construction

The Design-Build Team shall adhere to the following submittal guidelines:

- Submit all laboratory test results for review and approval
- Submit a sketch in plan view showing areas of the project to be stabilized by Cement Treated Base Course and application rates
- Submit any other documentation that supports the Design-Build Team's recommendations

Construction of Cement Treated Base Course

The Design-Build Team shall construct the Cement Treated Base Course as specified in Section 540 of the North Carolina Department of Transportation 2012 *Standard Specifications for Roads and Structures* except that Articles 540-5, 540-7 and 540-13 do not apply.

Unconfined Compressive Strength

For Cement Treated Base Course, the Design-Build Team shall make field specimens, cure them for seven days and test them in the laboratory. The minimum and maximum acceptable unconfined compressive strength for soil cement shall be 450 psi and 850 psi, respectively. One test shall be required for every 400 feet per lane width at random locations selected using random number tables.

Submittals for Review During Construction

The Design-Build Team shall submit the unconfined compressive strength test results for review and acceptance.

PRICE ADJUSTMENTS FOR ASPHALT BINDER

(9-1-11)

DB6 R25

Price adjustments for asphalt binder for plant mix will be made in accordance with Section 620 of the 2012 *Standard Specifications for Roads and Structures*.

When it is determined that the monthly selling price of asphalt binder on the first business day of the calendar month during which the last day of the partial payment period occurs varies either upward or downward from the Base Price Index, the partial payment for that period will be adjusted. The partial payment will be adjusted by adding the difference (+ or -) of the base price index subtracted from the monthly selling price multiplied by the total theoretical quantity of asphalt binder authorized for use in the plant mix placed during the partial payment period involved.

The base price index for asphalt binder for plant mix is **\$561.07 per ton**.

This base price index represents an average of F.O.B. selling prices of asphalt binder at supplier's terminals on **January 1, 2014**.

PRICE ADJUSTMENTS - ASPHALT CONCRETE PLANT MIX

(9-1-11) (Rev. 3-13-13)

DB6 R26

Revise the 2012 *Standard Specifications for Roads and Structures* as follows:

Page 6-18, Article 609-11 and Page 6-35, Article 610-14

Add the following paragraph before the first paragraph:

The “Asphalt Price” used to calculate any price adjustments set forth in this section shall be \$40 per theoretical ton. This price shall apply for all mix types.

DYNAMIC MESSAGE SIGN (DMS)

(07-24-13)

DB08-04

I. General Requirements

Conform to these Project Special Provisions, plans developed by the Design-Build Team, and the 2012 *Standard Specifications for Roads and Structures*.

DMSs used on the State Highway System shall be preapproved on the current NCDOT ITS & Signals 2012 Qualified Products List (QPL) by the date of installation. DMSs not preapproved will not be allowed for use on the project. To ensure compatibility with the existing DMS

Control Software deployed in the State, furnish NTCIP compliant DMSs that are fully compatible with Daktronics, Inc. Vanguard Version 4 software (also referred to hereinafter as the “Control Software”). The QPL is available on the Department’s website. The QPL website is: <http://www.ncdot.org/doh/preconstruct/traffic/ITSS/SMS/qpl/>

II. DMS Requirements

Furnish and install DMSs compliant with UL standards 48, 50, 879, and 1433.

Add and configure the new DMSs in the system using the Control Software and computer system. Furnish, install, test, integrate and make fully operational the new DMSs at locations shown in the plans developed by the Design-Build Team.

Furnish operating DMS systems consisting of, but not limited to, the following:

- Full Matrix, 27 pixel high and 90 pixels wide LED DMS
- DMS mounting hardware
- DMS controllers, Uninterruptible Power Supplies (UPS), cabinets and accessories with interconnect and power cabling and conduit
- Branch circuit conductors and related equipment
- All other equipment and incidentals required for furnishing, installing, and testing the DMS system and system components

Use only UL listed and approved electronic and electrical components in the DMS system.

MATERIALS

A. Environmental Requirements

Construct the DMS and DMS controller cabinet so the equipment within is protected against moisture, dust, corrosion, and vandalism.

Design the DMS system to comply with the requirements of Section 2.1 (Environmental and Operating Standards) of NEMA TS 4-2005.

B. Full Matrix LED Dynamic Message Sign (DMS)

Construct the DMS to display at least three lines of text that, when installed, are clearly visible and legible to a person with 20/20 corrected vision from a distance of + in height and composed from a luminous dot matrix. Provide an entire LED matrix that is a minimum of 27 pixels high and 90 pixels wide.

1. DMS Enclosure

Comply with the requirements of Section 3 (Sign Mechanical Construction) of NEMA TS 4-2005 as it applies to walk-in enclosures. The following requirements complement TS 4-2005:

- Construct the DMS with a metal walk-in enclosure excluding the face. Provide an aluminum walking platform inside the enclosure that is at least 28 inches wide. Ensure the width of the walking platform is free of obstructions to a height of 7 feet. Construct the enclosure of welded aluminum type 6061-T6, 5052-H38, 5052-H34, or of an Engineer approved alternate at least 1/8-inch thick. Perform all welding of aluminum and aluminum alloys in accordance with the latest edition of AWS D1.2, Structural Welding Code - Aluminum. Continuously weld the seams using Gas Metal Arc Welding (GMAW).
- Provide all exterior and interior DMS enclosure surfaces with natural, mill-finish aluminum. Remove all grind marks and discoloration from the surfaces.
- Provide corrosion resistant nuts, bolts, washers, and other mounting and bonding parts and components used on the exterior of the DMS enclosure and ensure they are sealed against water intrusion.
- Provide one key lockable, hinged, gasket-sealed inspection door for service and maintenance along each side of the enclosure. Install one appropriately sized fire extinguisher within 12 inches of each maintenance door. Equip the DMS enclosure with internal fluorescent lighting controlled by timers installed close to each inspection door. Make certain no light emitted from the fluorescent tubes or any other light source inside the enclosure not comprising the display is leaked to the outside of the enclosure. Equip the door with a door-hold-open device. Install GFCI duplex utility receptacles every 6 feet along the width of the DMS in convenient locations for powered service tools.
- Do not place a manufacturer name, logo, or other information on the front face of the DMS or shield visible to the motorist.
- Provide power supply monitoring circuitry to detect power failure in the DMS and to automatically report this fault to the Control Software. This requirement is in addition to reporting power failure at the controller cabinet.
- Do not paint the stainless steel bolts on the Z-bar assemblies used for mounting the enclosure.

2. DMS Interior Environment Control

Design the local field controller to monitor and control the interior DMS environment. Design environmental control to maintain the internal DMS temperature within +/- 10° F of the outdoor ambient temperature. Provide the DMS environmental control system with four primary subsystems as follows:

1. Internal Temperature Sensors – Provide the DMS with two internally mounted temperature sensors which are equipped with external thermocouples and which the field controller continuously monitors. Design the field controller to use this temperature information to determine when to activate and deactivate the environmental control systems described herein. Locate sensors on opposite ends of the upper 1/3 of the LED display matrix with their external thermocouples

- attached to and making contact with an LED pixel circuit board. Design the thermocouple and LED board to be easily detachable, in the event that one of the units requires removal and replacement. Provide sensors capable of measuring temperatures from -40° F to $+185^{\circ}$ F. Design the field controller to automatically shut down the LED display whenever one or both sensors indicates that LED board temperature has exceeded $+140^{\circ}$ F, and to automatically restart the LED display whenever the temperature falls below $+130^{\circ}$ F. Design both shutdown and re-start temperature thresholds to be user-programmable. Design the field controller to report sensor temperatures and DMS shutdown/re-start events to the DMS Control Software.
2. Housing Cooling System – Provide the DMS housing with a cooling system that circulates outside air into the DMS housing whenever the LED board temperature exceeds a user-programmable threshold. Provide this system with enough ventilation fans to exchange the internal DMS housing air volume at a minimum rate of 2 times per minute. Provide steel ball-bearing type fans. Mount fans in a line across the upper rear wall of the DMS housing to direct air out of the cabinet. Provide one filtered air intake port for each exhaust fan. Locate intake ports in a line across the lower rear wall of the DMS housing. Provide intake ports with a removable filter that will remove airborne particles measuring 500 microns in diameter and larger. Provide a filter that is of a size and style that is commercially readily available. Program the field controller to activate the DMS housing cooling system whenever the LED board temperature exceeds $+90^{\circ}$ F and to turn the cooling system off whenever LED board temperature falls below $+85^{\circ}$ F. On the DMS housing rear exterior wall, cover all air intake and exhaust ports on their top, front, and sides by an aluminum shroud fabricated from 0.090-inch aluminum sheeting. Taper the shrouds at the top. Securely fasten shrouds to the DMS housing, and provide gaskets at the interface to prevent water from entering the DMS. Design all air filters and fans to be removable from inside the DMS housing. Provide the DMS housing cooling system with an adjustable timer that will turn fans off after the set time has expired. Provide a timer that is adjustable to at least 4 hours, and locate it just inside the DMS housing door, within easy reach of a maintenance technician standing outside the DMS doorway.
 3. LED Display Cooling System – Provide the DMS with an LED display cooling system which directs air across the LED display modules whenever LED board temperature exceeds a user-programmable threshold. Direct fan-forced air vertically across the backside of the entire LED display matrix using multiple ball-bearing fans. Program the field controller to activate the LED cooling fan system whenever LED board temperature exceeds $+90^{\circ}$ F and to deactivate the system whenever LED board temperature falls to $+85^{\circ}$ F. Locate cooling fans so as not to hinder removal of LED display modules and driver boards.
 4. Front Face Panel Defog/Defrost System – Provide the DMS with a defog/defrost system which circulates warm, fan-forced air across the inside of the polycarbonate front face whenever LED board temperature falls below a user-programmable threshold. Provide multiple steel ball-bearing fans that provide uniform airflow across the face panel. Program the field controller to activate the

defog/defrost system whenever LED board temperature falls below +40° F and to deactivate the defog/defrost system whenever LED board temperature exceeds +106° F. Mount a 100-watt pencil-style heating element in front of each defog/defrost fan to warm the air directed across the DMS face. Design heating elements to be on only when the defog/defrost fans are on.

Install additional fans and/or heaters as needed to maintain the temperature inside the DMS enclosure within the operating temperature range of the equipment within the DMS enclosure as recommended by the equipment manufacturer(s).

3. Front Panel

Protect the DMS face with contiguous, weather-tight, removable panels. These panels must be a polycarbonate material that are ultraviolet protected, have an antireflection coating, and are a minimum of 1/8- inch thick.

Furnish polycarbonate panels with the following characteristics:

- Tensile Strength, Ultimate: 10,000 PSI
- Tensile Strength, Yield: 9,300 PSI
- Tensile Strain at Break: 125%
- Tensile Modulus: 330,000 PSI
- Flexural Modulus: 330,000 PSI
- Impact Strength, Izod (1/8", notched): 17 ft-lbs/inch of notch
- Rockwell Hardness: M75, R118
- Heat Deflection Temperature Under Load: 264 PSI at 270F and 66 PSI at 288F
- Coefficient of Thermal Expansion: 3.9×10^{-5} in/in/F
- Specific Heat: 0.30 BTU/lb/F
- Initial Light Transmittance: 85% minimum
- Change in Light Transmittance, 3 years exposure in a Southern latitude: 3%
- Change in Yellowness Index, 3 years exposure in a Southern latitude: less than 5%

For substitutes, submit one 12" x 12" sample of the proposed material together with a description of the material attributes to the Engineer for review and approval. Install a .09" aluminum mask on the front of the panel (facing the motorists) that contains a circular opening for each LED pixel. Prime and coat the front side of the aluminum mask, which faces the viewing motorists, with automotive-grade flat black acrylic enamel paint or an approved equivalent. Guarantee all painted surfaces provide a minimum outdoor service life of 20 years.

Design the panels so they will not warp nor reduce the legibility of the characters. Differential expansion of the DMS housing and the front panel must not cause damage to any DMS component or allow openings for moisture or dust. Glare from sunlight, roadway lighting, commercial lighting, or vehicle headlights must not reduce the legibility or visibility of the DMS. Install the panels so that a maintenance person can easily remove or open them for cleaning.

4. Display Modules

Manufacture each display module with a standard number of pixels, not to exceed an array of 9 x 5, which can be easily removed. Assemble the modules onto the DMS assemblies contiguously to form a continuous matrix to display the required number of lines, characters, and character height.

Design display modules that are interchangeable and replaceable without using special tools. Provide plug-in type power and communication cables to connect to a display module.

Construct each display module as a rectangular array of 5 horizontal pixels by 7 to 9 vertical pixels. Provide the module with an equal vertical and horizontal pitch between pixels, and columns that are perpendicular to the rows (i.e., no slant). Design each module to display:

- All upper and lower case letters.
- All punctuation marks.
- All numerals 0 to 9.
- Special user-created characters.

Display upper-case letters and numerals over the complete height of the module. Optimize the LED grouping and mounting angle within a pixel for maximum readability.

Furnish two (2) spare Display Modules per each DMS for emergency restoration.

5. Discrete LEDs

Provide discrete LEDs with a nominal viewing cone of **30 degrees** with a half-power angle of 15 degrees measured from the longitudinal axis of the LED. Make certain, the viewing cone tolerances are as specified in the LED manufacturer's product specifications and do not exceed +/- 3 degrees half-power viewing angle of 30 degrees.

Provide LEDs that are untinted, non-diffused, high output solid state lamps utilizing indium gallium aluminum phosphide (InGaAlP) technology. Provide T1 3/4, 0.2 inch size LEDs that emit a true amber color at a wavelength of 590 ± 5 nm.

Provide LEDs with a MTBF (Mean Time Before Failure) of at least 100,000 hours of permanent use at an operating point of 140° F or below at a specific forward current of 20mA. Discrete LED failure is defined as the point at which the LED's luminous intensity has degraded to 50% or less of its original level.

Obtain the LEDs used in the display from a single LED manufacturer that have a single part number. Obtain them from batches sorted for luminous output, where the highest luminosity LED is not more than fifty percent more luminous than the lowest luminosity LED when the LEDs are driven at the same forward current. Do not use more than two

successive and overlapping batches in the LED display. Document the procedure to be used to comply with this requirement as part of the material submittal.

Individually mount the LEDs on circuit boards that are at least 1/16" thick FR-4 fiberglass, flat black printed circuit board in a manner that promotes cooling. Protect all exposed metal on both sides of the LED pixel board (except the power connector) from water and humidity exposure by a thorough application of acrylic conformal coating. Design the boards so bench level repairs to individual pixels, including discrete LED replacement and conformal coating repair is possible.

Operate the LED display at a low internal DC voltage not to exceed 24 Volts.

Design the LED display operating range to be -20° F to +140° F at 95% relative humidity, non-condensing.

Supply the LED manufacturer's technical specification sheet with the material submittals.

6. LED Power Supplies

Power the LED Display by means of multiple regulated switching DC power supplies that operate from 120 volts AC input power and have an output of 48 volts DC or less. Wire the supplies in a redundant parallel configuration that uses multiple power supplies per display. Provide the supplies with current sharing capability that allows equal amounts of current to their portion of the LED display. Provide power supplies rated such that if one supply fails the remaining supplies will be able to operate their portion of the display under full load conditions (i.e. all pixels on at maximum brightness) and at a temperature of 140° F.

Provide power supplies to operate within a minimum input voltage range of +90 to +135 volts AC and within a temperature range of -22° F to 140° F. Power supply output at 140° F must not deteriorate to less than 65% of its specified output at 70° F. Provide power supplies that are overload protected by means of circuit breakers, that have an efficiency rating of at least 75%, a power factor rating of at least .95, and are UL listed. Provide all power supplies from the same manufacturer and with the same model number. Design the power driver circuitry to minimize power consumption.

Design the field controller to monitor the operational status (normal or failed) of each individual power supply and be able to display this information on the Client Computer screen.

7. LED Pixels

A pixel is defined as the smallest programmable portion of a display module that consists of a cluster of closely spaced discrete LEDs. Design each pixel to be a maximum of 2 inches in diameter.

Construct the pixels with two strings of LEDs. It is the manufacturer's responsibility to determine the number of LEDs in each string to produce the candela requirement as stated herein.

Ensure each pixel produces a luminous intensity of 40 Cd when driven with an LED drive current of 20 mA per string.

Power the LEDs in each pixel in strings. Use a redundant design so that the failure of an LED in one string does not affect the operation of any other string within the pixel. Provide the sign controller with the ability to detect the failure of any LED string and identify which LED string has failed. Submit a complete schematic of the LED power and driver circuits with the material submittals.

8. Character Display

Design display modules to be easily removable without the use of tools. Position cooling fans so they do not prevent removal of an LED pixel board or driver board.

Use continuous current to drive the LEDs at the maximum brightness level. Design the light levels to be adjustable for each DMS / controller so the Engineer may set levels to match the luminance requirements at each installation site.

Design the controller to automatically detect failed LED strings or drivers and initiate a report of the event to the Control Software. Design the controller to be able to read the internal temperature of the DMS enclosure and the ambient temperature outside the DMS enclosure and report these to the Control Software.

9. Display Capabilities

Design the DMS with at least the following message displays:

Static display

Flashing display with Dynamic flash rates

At least two alternating Static and / or Flashing sequences (multi-page messages)

10. DMS Mini Controller

Furnish and install a mini controller inside the DMS that is interconnected with the main controller using a fiber optic cable, CAT-5 cable, or an approved alternate. The mini controller will enable a technician to perform all functions available from the main controller. Provide the mini controller with an LCD/keypad interface. Size the LCD display screen to allow preview of an entire one-page message on one screen. Provide a 4 X 4 keypad.

Alternatively, install an EIA/TIA-232E port inside the DMS enclosure to enable a maintenance technician to communicate with the DMS main controller and obtain access to and perform all functions of the main controller using a laptop computer.

C. DMS Enclosure Structure Mounting

Mount the DMS enclosure and interconnect system securely to the existing support structures. Design the DMS enclosure supports allow full access to the DMS enclosure inspection door. On existing structures, ensure the walkway does not interfere with full access to the DMS enclosure inspection door.

Furnish and install U-bolt connections of hanger beams to overhead assembly truss chords with a double nut at each end of the U-bolt. Bring the double nuts tight against each other by the use of two wrenches.

Submit plans for the DMS enclosure, mounting description and calculations to the Engineer for approval. Have such calculations and drawings approved by a Professional Engineer registered in the state of North Carolina, and bear his signature, seal, and date of acceptance.

Provide removable lifting eyes or the equivalent on the DMS enclosure rated for its total weight to facilitate handling and mounting the DMS enclosure.

Design the DMS structure to conform to the applicable requirements of the Standard Specifications for Structural *Supports for Highway Signs, Luminaires*, and the section titled "DMS Assemblies" of these Project Special Provisions.

D. DMS / DMS Controller Interconnect

Furnish and install all necessary cabling, conduit, and terminal blocks to connect the DMS and the DMS controller. Use approved manufacturer's specifications and the Plans for cable and conduit types and sizes. Use fiber optic cable to interconnect sign and controller. Install fiber optic interconnect centers in the sign enclosure and cabinet to securely install and terminate the fiber optic cable. Submit material submittal cut sheets for the interconnect center.

E. DMS Controller and DMS Cabinet

Furnish and install one DMS controller with accessories per DMS in a new equipment cabinet. Mount the controller cabinet on the DMS support structure. Install cabinet so that the height from the ground to the middle of the cabinet is 4 feet. Ensure a minimum of 3 feet level working surface under each cabinet that provides maintenance technicians with a safe working environment.

Provide the DMS controller as a software-oriented microprocessor and with resident software stored in non-volatile memory. The Control Software, controller and communications must comply with the NTCIP Standards identified in these Project Special Provisions. Provide sufficient non-volatile memory to allow storage of at least 500 multi-page messages and a test pattern program.

Furnish the controller cabinet with, but not limited to, the following:

- Power supply and distribution assemblies
- Power line filtering hybrid surge protectors
- Radio Interference Suppressor
- Communications surge protection devices
- Industrial-Grade UPS system and local disconnect
- Microprocessor-based controller
- Display driver and control system (unless integral to the DMS)
- Serial interface port for local laptop computer
- Local user interface
- Interior lighting and duplex receptacle
- Adjustable shelves as required for components
- Temperature control system
- All interconnect harnesses, connectors, and terminal blocks
- All necessary installation and mounting hardware

Furnish the DMS controller and associated equipment completely housed in a NEMA 3R cabinet made from 5052-H32 sheet aluminum at least 1/8" thick. Use natural aluminum cabinets. Perform all welding of aluminum and aluminum alloys in accordance with the latest edition of AWS D1.2, Structural Welding Code - Aluminum. Continuously weld the seams using Gas Metal Arc Welding (GMAW).

Slant the cabinet roof away from the front of the cabinet to prevent water from collecting on it.

Do not place a manufacturer name, logo, or other information on the faces of the controller cabinet visible to the motorist.

Provide cabinets capable of housing the components and sized to fit space requirement. Design the cabinet layout for ease of maintenance and operation, with all components easily accessible. Submit a cabinet layout plan for approval by the Engineer.

Locate louvered vents with filters in the cabinet to direct airflow over the controller and auxiliary equipment, and in a manner that prevents rain from entering the cabinet. Fit the inside of the cabinet, directly behind the vents, with a replaceable, standard-size, commercially available air filter of sufficient size to cover the entire vented area.

Provide a torsionally rigid door with a continuous stainless steel hinge on the side that permits complete access to the cabinet interior. Provide a gasket as a permanent and weather resistant seal at the cabinet door and at the edges of the fan / exhaust openings. Use a non-absorbent gasket material that will maintain its resiliency after long-term exposure to the

outdoor environment. Construct the doors so that they fit firmly and evenly against the gasket material when closed. Provide the cabinet door with louvered vents and air filters near the bottom as described in the paragraph above.

The cabinet shall contain a full-height standard EIA 19-inch rack. The rack shall be secured within the cabinet by mounts at the top and bottom.

The rack shall contain a minimum of one (1) pullout drawer. The drawer shall be suitable for storing manuals and small tools, such as screwdrivers. The drawer shall be able to latch in the out position to function as a laptop/utility shelf.

Provide a convenient location on the inside of the door to store the cabinet wiring diagrams and other related cabinet drawings. Provide a Corbin #2 main door lock made of non-ferrous or stainless steel material. Key all locks on the project alike, and provide 10 keys to the Engineer. In addition, design the handle to permit pad-locking.

Provide the interior of the cabinet with ample space for housing the controller and all associated equipment and wiring; use no more than 75% of the useable space in the cabinet. Provide ample space in the bottom of the cabinet for the entrance and exit of all power, communications, and grounding conductors and conduit.

Arrange the equipment so as to permit easy installation of the cabling through the conduit so that they will not interfere with the operation, inspection, or maintenance of the unit. Provide adjustable metal shelves, brackets, or other support for the controller unit and auxiliary equipment. Leave a 3 inch minimum clearance from the bottom of the cabinet to all equipment, terminals, and bus bars.

Provide power supply monitoring circuitry to detect power failure and to automatically report the occurrence to the Control Software.

Install two 15-watt fluorescent light strips with shields, one in the top of the cabinet and the other under the bottom shelf. Design both lights to automatically turn on when the cabinet door is opened and turn off when the door closes.

Mount and wire a 120V (+10%) GFCI duplex receptacle of the 3-wire grounding type in the cabinet in a location that presents no electrical hazard when used by service personnel for the operation of power tools and work lights.

No cabinet resident equipment may utilize the GFCI receptacle. Furnish one spare non-GFCI receptacle for future equipment.

Mount a bug-proof and weatherproof thermostatically controlled fan and safety shield in the top of the cabinet. Size the fan to provide at least for two air exchanges per minute. Fuse the fan at 125% of the capacity of the motor. The magnetic field of the fan motor must not affect the performance of the control equipment. Use a fan thermostat that is manually adjustable to turn on between 80°F and 160°F with a differential of not more than 10°F between automatic turn-on and turn-off. Mount it in an easily accessible location, but not within 6 inches of the fan.

Install additional fans and / or heaters as needed to maintain the temperature inside the cabinet within the operating temperature range of the equipment within the cabinet as recommended by equipment manufacturer(s).

1. Wiring

The requirements stated herein apply wherever electrical wiring is needed for any DMS system assemblies and subassemblies such as controller cabinet, DMS enclosure, electrical panel boards and etc.

Neatly arrange and secure the wiring inside the cabinet. Where cable wires are clamped to the walls of the control cabinet, provide clamps made of nylon, metal, plastic with rubber or neoprene protectors, or similar. Lace and jacket all harnesses, or tie them with nylon tie wraps spaced at 6 inches maximum to prevent separation of the individual conductors.

Individually and uniquely label all conductors. Ensure all conductor labels are clearly visible without moving the conductor. Connect all terminal conductors to the terminal strip in right angles. Remove excess conductor before termination of the conductor. Mold the conductor in such a fashion as to retain its relative position to the terminal strip if removed from the strip. Do not run a conductor across a work surface with the exception of connecting to that work surface. No conductor bundles can be support by fasteners that support work surfaces. Install all connectors, devices and conductors in accordance to manufactures guidelines. Comply with the latest NEC guideline in effect during installation. No conductor or conductor bundle may hang loose or create a snag hazard. Protect all conductors from damage. Ensure all solder joints are completed using industry accepted practices and will not fail due to vibration or movement. Protect lamps and control boards from damage.

No splicing will be allowed for feeder conductors and communication cables from the equipment cabinet to the DMS enclosure.

Insulate all conductors and live terminals so they are not hazardous to maintenance personnel.

Route and bundle all wiring containing line voltage AC and / or shield it from all low voltage control circuits. Install safety covers to prevent accidental contact with all live AC terminals located inside the cabinet.

Use industry standard, keyed-type connectors with a retaining feature for connections to the controller.

Label all equipment and equipment controls clearly.

Supply each cabinet with one complete set of wiring diagrams that identify the color-coding or wire tagging used in all connections. Furnish a water-resistant packet adequate for storing wiring diagrams, operating instructions, and maintenance manuals with each cabinet.

2. Power Supply and Circuit Protection

Design the DMS and controller for use on a system with a line voltage of $120V \pm 10\%$ at a frequency of $60 \text{ Hz} \pm 3 \text{ Hz}$. Under normal operation, do not allow the voltage drop between no load and full load of the DMS and its controller to exceed 3% of the nominal voltage.

Blackout, brownout, line noise, chronic over-voltage, sag, spike, surge, and transient effects are considered typical AC voltage defects. Protect the DMS system equipment so that these defects do not damage the DMS equipment or interrupt their operation. Equip all cabinets with devices to protect the equipment in the cabinet from damage due to lightning and external circuit power and current surges.

3. Circuit Breakers

Protect the DMS controller, accessories, and cabinet utilities with thermal magnetic circuit breakers. Provide the controller cabinet with a main circuit breaker sized according to the NEC. Use appropriately sized branch circuit breakers to protect the controller and accessories and for servicing DMS equipment and cabinet utilities.

4. Surge Suppressor

Install and clearly label filtering hybrid power line surge protectors on the load side of the branch circuit breakers in a manner that permits easy servicing. Ground and electrically bond the surge protector to the cabinet within 2 inches.

Provide power line surge protector that meets the following requirements:

Peak surge current occurrences	20 minimum
Peak surge current for an 8 x 20 microsecond waveshape	50,000 amperes
Energy Absorption	> 500 Joules
Clamp voltage	240 volts
Response time	<1 nanosecond
Minimum current for filtered output	15 amperes for 120VAC*
Temperature range	-40°F to +158°F

*Capable of handling the continuous current to the equipment

5. Radio Interference Suppressor

Provide each controller cabinet with sufficient electrical and electronic noise suppression to enable all equipment in it to function properly. Provide one or more radio interference suppressors (RIS) connected between the stages of the power line surge suppressor that minimize interference generated in the cabinet in both the broadcast and the aircraft frequencies. Each RIS must provide a minimum attenuation of 50 decibels over a

frequency range of 200 KHz to 75 MHz. Clearly label the suppressor(s) and size them at least at the rated current of the main circuit breaker but not less than 50 amperes.

Provide RIS that are hermetically sealed in a substantial metal case which is filled with a suitable insulating compound and have nickel-plated 10/24 brass stud terminals of sufficient external length to provide space to connect #8 AWG wires. Mount them so that the studs cannot be turned in the case. Properly insulate ungrounded terminals from each other, and maintain a surface linkage distance of not less than ¼” between any exposed current conductor and any other metallic parts. The terminals must have an insulation factor of 100-200 MΩ, dependent on external circuit conditions. Use RIS designed for 120 VAC \pm 10%, 60Hz, and which meet the standards of UL and the Radio Manufacturers Association.

6. Communications Surge Protector

Equip the cabinet with properly labeled hybrid data line surge protectors that meet the following general requirements:

Surge current occurrences at 2000 ampere, 8 x 20 microsecond waveform	> 80
Surge current occurrences at 400 ampere, 10x700 microsecond waveform	> 80
Peak surge current for 8 x 20 microsecond waveform	10,000 A (2500 A/line)
Peak surge current for 10x700 microsecond waveform	500 A/line
Response time	< 1 nanosecond
Series resistance	< 15 Ω
Average capacitance	1500 pF
Temperature range	-10°F to 150°F
Clamp Voltage	As required to match equipment in application

7. Lightning Arrester

Protect the system with an UL-approved lightning arrester installed at the main service disconnect that meets the following requirements:

Type of design	Silicon Oxide Varistor
Voltage	120/240 Single phase, 3 wires
Maximum current	100,000 amps
Maximum energy	3000 joules per pole
Maximum number of surges	Unlimited

Response time one milliamp test	5 nanoseconds
Response time to clamp 10,000 amps	10 nanoseconds
Response time to clamp 50,000 amps	25 nanoseconds
Leak current at double the rated voltage	None
Ground Wire	Separate

8. Uninterruptible Power Supply (UPS)

Provide the cabinet with an industrial grade power conditioning UPS unit to supply continuous power to operate the equipment connected to it if the primary power fails. The UPS must detect a power failure and provide backup power within 20 milliseconds. Transition to the UPS source from primary power must not cause loss of data or damage to the equipment being supplied with backup power. Provide an UPS with at least three outlets for supplying conditioned AC voltage to the DMS controller. Provide a unit to meet the following requirements:

- Input Voltage Range: 120VAC +12%, -25%
- Power Rating: 1000 VA, 700 Watts
- Input Frequency: 45 to 65 Hz
- Input Current: 7.2A
- Output Voltage: 120VAC +/- 3%
- Output Frequency: 50/60 +/-1 Hz
- Output Current: 8.3A
- Output Crest Factor Ration: @50% Load Up to 4.8:1
@75% Load Up to 3.2:1
@100% Load Up to 2.4:1
- Output THD: 3% Max. (Linear)
5% Max. (Non-Linear)
- Output Overload: 110% for 10 min; 200% for 0.05 sec.
- Output Dynamic Response: +/- 4% for 100% Step Load Change
0.5 ms Recovery Time.
- Output Efficiency @ 100% Load: 90% (Normal Mode)
- Operating Temperature: -40 °F to +165 °F
- Humidity: 0% to 95% Non-condensing
- Remote Monitoring Interface: RS-232

- Protection: Input/Output Short Circuit
Input/Output Overload
Excessive Battery Discharge
- Specifications: UL1778, FCC Class A, IEEE 587

Provide the UPS unit capable of supplying 30 minutes of continuous backup power to the equipment connected to it when the equipment is operating at full load.

9. Controller Communications Interface

Provide the controller with the following interface ports:

- An EIA/TIA-232E port for remote communication using NTCIP
- An 10/100 Ethernet port for remote communication using NTCIP
- An EIA/TIA-232E port for onsite access using a laptop
- An EIA/TIA-232E auxiliary port for communication with a field device such as a UPS
- Fiber Optic ports for communication with the sign
- RJ45 ports for communication with the sign using CAT-5 cable
- RJ45 ports for communication with mini-controller located inside the sign enclosure

10. Controller Local User Interface

Provide the controller with a Local User Interface (LUI) for at least the following functions:

- On / Off Switch: controls power to the controller.
- Control Mode Switch: for setting the controller operation mode to either remote or local mode.
- LCD Display and Keypad: Allow user to navigate through the controller menu for configuration (display, communications parameter, etc.) running diagnostics, viewing peripherals status, message creation, message preview, message activation, and etc. Furnish a LCD display with a minimum size of 240x64 dots with LED back light.

11. Controller Address

Assign each DMS controller a unique address. Preface all commands from the Control Software with a particular DMS controller address. The DMS controller compares its address with the address transmitted; if the addresses match, then the controller processes the accompanying data.

12. Controller Functions

Design the DMS controller to continuously control and monitor the DMS independent of the Control Software. Design the controller to display a message on the sign sent by the Control Software, a message stored in the sign controller memory, or a message created on-site by an operator using the controller keypad.

Provide the DMS controller with a watchdog timer to detect controller failures and to reset the microprocessor, and with a battery backed-up clock to maintain an accurate time and date reference. Set the clock through an external command from the Control Software or the Local User Interface.

13. DMS Controller Memory

Furnish each DMS controller with non-volatile memory. Use the non-volatile memory to store and reprogram at least one test pattern sequence and 500 messages containing a minimum of two pages of 45 characters per page. The Control Software can upload messages into and download messages from each controller's non-volatile memory remotely.

Messages uploaded and stored in the controller's non-volatile memory may be erased and edited using the Control Software and the controller. New messages may be uploaded to and stored in the controller's non-volatile memory using the Control Software and the controller.

14. Photo-Electric Sensors

Install three photoelectric sensors with 1/2-inch minimum diameter photosensitive lens inside the DMS enclosure. Use sensors that will operate normally despite continual exposure to direct sunlight. Place the sensors so they are accessible and field adjustable. Point one sensor north or bottom of the sign. Place the other two, one on the back wall and one on the front wall of the sign enclosure. Alternate designs maybe accepted, provided the sensor assemblies are accessible and serviceable from inside the sign enclosure.

Provide controls so that the Engineer can field adjust the following:

- The light level emitted by the pixels elements in each Light Level Mode.
- The ambient light level at which each Light Level Mode is activated.

F. Equipment List

Provide a general description of all equipment and all information necessary to describe the basic use or function of the major system components. Include a general "block diagram" presentation. Include tabular charts listing auxiliary equipment, if any is required. Include the nomenclature, physical and electrical characteristics, and functions of the auxiliary equipment unless such information is contained in an associated manual; in this case include a reference to the location of the information. Include an itemized list of equipment costs.

Include a table itemizing the estimated average and maximum power consumption for each major piece of equipment.

G. Physical Description

Provide a detailed physical description of size, weight, center of gravity, special mounting requirements, electrical connections, and all other pertinent information necessary for proper installation and operation of the equipment.

H. Parts List

Provide a parts list that contains all information needed to describe the characteristics of the individual parts, as required for identification. Include a list of all equipment within a group and a list of all assemblies, sub-assemblies, and replacement parts of all units. Arrange this data in a table, in alpha-numerical order of the schematic reference symbols, which gives the associated description, manufacturer's name, and part number, as well as alternate manufacturers and part numbers. Provide a table of contents or other appropriate grouping to identify major components, assemblies, etc.

I. Character Set Submittal

Submit an engineering drawing of the DMS character set including 26 upper case and lower case letters, 10 numerals, an asterisk (*), a dash, a plus sign (+), a designated lane diamond, a slash, an ampersand, and arrows at 0, 45, 90, 135, 180, 225, 270, and 315 degrees.

J. Wiring Diagrams

Provide a wiring diagram for each DMS and each controller cabinet, as well as interconnection wiring diagrams for the system as a whole.

Provide complete and detailed schematic diagrams to component level for all DMS assemblies and subassemblies such as driver boards, control boards, DMS controller, power supplies, and etc. Ensure that each schematic enables an electronics technician to successfully identify any component on a board or assemblies and trace its incoming and outgoing signals.

K. Routine of Operation

Describe the operational routine, from necessary preparations for placing the equipment into operation to securing the equipment after operation. Show appropriate illustrations with the sequence of operations presented in tabular form wherever applicable. Include in this section a total list of the test instruments, aids and tools required to perform necessary measurements and measurement techniques for each component, as well as set-up, test, and calibration procedures.

L. Maintenance Procedures

Specify the recommended preventative maintenance procedures and checks at pre-operation, monthly, quarterly, semi-annual, annual, and "as required" periods to assure equipment

operates reliably. List specifications (including tolerances) for all electrical, mechanical, and other applicable measurements and / or adjustments.

M. Repair Procedures

Include in this section all data and step-by-step procedures necessary to isolate and repair failures or malfunctions, assuming the maintenance technicians are capable of analytical reasoning using the information provided in the section titled “Wiring Diagrams and Theory of Operation.”

Describe accuracy, limits, and tolerances for all electrical, physical, or other applicable measurements. Include instructions for disassemblies, overhaul, and re-assemblies, with shop specifications and performance requirements.

Give detailed instructions only where failure to follow special procedures would result in damage to equipment, improper operation, danger to operating or maintenance personnel, etc. Include such instructions and specifications only for maintenance that specialized technicians and engineers in a modern electromechanical shop would perform. Describe special test set-up, component fabrication, and the use of special tools, jigs, and test equipment.

N. Field Trial

At the request of the Engineer, supply a three character demonstration module with characters of the size and type specified for the project, an appropriate control device and power supply to allow character display within 30 working days of the request. Perform a field trial on this module at a time and location selected by the Engineer. This trial will allow the Engineer or his selected representatives to test the readability of the DMS at the maximum distance required for specified character size. Test the module with the sun directly above the DMS, and near the horizon in front of and behind the DMS (washout and back-lit conditions).

III. Construction Methods

A. Description

This article establishes practices and procedures and gives minimum standards and requirements for the installation of Dynamic Message Sign systems, auxiliary equipment and the construction of related structures.

Provide electrical equipment described in this specification that conforms to the standards of NEMA, UL, or Electronic Industries Association (EIA), wherever applicable. Provide connections between controllers and electric utilities that conform to NEC standards. Express wire sizes according to the American Wire Gauge (AWG).

Provide stainless steel screws, nuts, and locking washers in all external locations. Do not use self-tapping screws unless specifically approved by the Engineer. Use parts made of corrosion-resistant materials, such as plastic, stainless steel, brass, or aluminum. Use

construction materials that resist fungus growth and moisture deterioration. Separate dissimilar metals by an inert dielectric material.

B. Layout

The Engineer will establish the actual location of each Dynamic Message Sign assemblies. It is the Design-Build Team's responsibility to ensure proper elevation, offset, and orientation of all DMS assemblies. Make actual field measurements to place conduit and equipment at the required location.

C. Construction Submittal

When the work is complete, submit "as built" plans, inventory sheets, and any other data required by the Engineer to show the details of actual construction and installation and any modifications made during installation.

The "as built" plans will show: the DMS, controller, and service pole locations; DMS enclosure and controller cabinet wiring layouts; and wire and conduit routing. Show all underground conduits and cables dimensioned from fixed objects.

Include detailed drawings that identify the routing of all conductors in the system by cable type, color code, and function. Clearly label all equipment in the DMS system, controller cabinet, and DMS enclosure.

D. Conduit

Install the conduit system in accordance with section 1715 of Standard Specification and NEC requirements for an approved watertight raceway.

Make bends in the conduit so as not to damage it or change its internal diameter. Install watertight and continuous conduit with as few couplings as standard lengths permit.

Clean conduit before, during, and after installation. Install conduit in such a manner that temperature changes will not cause elongation or contraction that might damage the system.

Attach the conduit system to and install along the structural components of the DMS structure assemblies with beam clamps or stainless steel strapping. Install strapping according to the strapping manufacturer's recommendations. Do not use welding or drilling to fasten conduit to structural components. Space the fasteners at no more than 4 feet for conduit 1.5 inches and larger or 6 feet for conduit smaller than 1.25 inches. Place fasteners no more than 3 feet from the center of bends, fittings, boxes, switches, and devices.

Flexible conduit will only be allowed when the conduits transition from the horizontal structure segment to the horizontal truss segment and from the horizontal truss segment to the rear entrance of the DMS when installing the DMS communications and feeder cables. The maximum length of flexible conduit allowed at each transition will be 5 feet.

Locate underground conduit as shown in the plans developed by the Design-Build Team in a manner consistent with these Project Special Provisions.

Do not exceed the appropriate fill ratio on all cable installed in conduit as specified in the NEC.

E. Wiring Methods

Do not pull permanent wire through a conduit system until the system is complete and has been cleaned.

Color-code all conductors per the NEC. Use approved marking tape, paint, sleeves or continuous colored conductors for No.8 AWG and larger. Do not mark a white conductor in a cable assemblies any other color.

Bury underground circuits at the depth shown in the plans developed by the Design-Build Team and surround it with at least 3 inches of sand or earth back-fill free of rocks and debris. Compact backfill in 6-inch layers. Do not splice underground circuits unless specifically noted in the plans developed by the Design-Build Team and approved by the Department.

F. Equipment and Cabinet Mounting

Mount equipment securely at the locations shown in the plans developed by the Design-Build Team, in conformance with the dimensions shown. Install fasteners as recommended by the manufacturer and space them evenly. Use all mounting holes and attachment points for attaching DMS enclosures and controller cabinets to the structures.

Drill holes for expansion anchors of the size recommended by the manufacturer of the anchors and thoroughly clean them of all debris.

Provide one key-operated, pin tumbler, dead bolt padlock, with brass or bronze shackle and case, conforming to Military Specification MIL-P-17802E (Grade I, Class 2, Size 2, Style A) for each electrical panel and switch on the project. Key all padlocks alike, and provide 10 keys to the Engineer.

Provide cabinets with all mounting plates, anchor bolts, and any other necessary mounting hardware in accordance with these Project Special Provisions and the plans developed by the Design-Build Team.

Seal all unused conduit installed in cabinets at both ends to prevent water and dirt from entering the conduit and cabinet with approved sealing material.

Install a ground bushing attached inside the cabinet on all metal conduits entering the cabinet. Connect these ground bushings to the cabinet ground bus.

G. Work Site Clean-Up

Clean the site of all debris, excess excavation, waste packing material, wire, etc. Clean and clear the work site at the end of each workday. Do not throw waste material in storm drains or sewers.

IV. NTCIP Requirements

This section defines the detailed NTCIP requirements for the DMSs.

A. References

This specification references several standards through their NTCIP designated names. The following list provides the full reference to the current version of each of these standards.

Implement the most recent version of the standard including any and all Approved or Recommended Amendments to these standards for each NTCIP Component covered by these project specifications.

Table 1: NTCIP Standards

Abbreviated Number	Full Number	Title
NTCIP 1101	NTCIP 1101:1997	<i>Simple Transportation Management Framework</i>
NTCIP 1201	NTCIP 1201:1997	<i>Global Object Definitions</i>
NTCIP 1203	NTCIP 1203:1997	<i>Object Definitions for Dynamic Message Signs</i>
NTCIP 2001	NTCIP 2001:1997	<i>Class B Profile</i>
NTCIP 2101	NTCIP 2101	<i>SP-PMPP/232 Subnet Profile for PMPP over RS-232</i>
NTCIP 2102	NTCIP 2102	<i>SP-PMPP/FSK Subnet Profile for PMPP over FSK Modem</i>
NTCIP 2103	NTCIP 2103	<i>SP-PPP/232 Subnetwork Profile for PPP over RS232 (Dial Up)</i>
NTCIP 2104	NTCIP 2104	<i>SP-Ethernet Subnet Profile for Ethernet</i>
NTCIP 2201	NTCIP 2201	<i>TP-Null Transport Profile</i>

NTCIP 2202	NTCIP 2202	<i>TP-InternetInternet Transport Profile (TCP/IP and UDP/IP)</i>
NTCIP 2301	NTCIP 2301	AP-STMF AP for Simple Transportation Management Framework

B. General Requirements

1. Subnet Level

Ensure each serial port on each NTCIP Component supports NTCIP 2103 over a dial-up connection with a contractor provided external modem with data rates of 28.8 kbps, 19.2 kbps, 14.4 kbps, 9600 bps, 4800 bps, 2400 bps, 1200 bps, 600 bps, and 300 bps. Enable the NTCIP Component to make outgoing and receive incoming calls as necessary and support the following modem command sets:

- Hayes AT - Command Set
- MNP5
- MNP10
- V.42bis

Ensure each serial port on each NTCIP Component supports NTCIP 2103 over a null-modem connection with data rates of 19.2 kbps, 14.4 kbps, 9600 bps, 4800 bps, 2400 bps, 1200 bps, 600 bps, and 300 bps.

Ensure each serial port on each NTCIP Component supports NTCIP 2101 with data rates of 9600 bps, 4800 bps, 2400 bps, 1200 bps, 600 bps, and 300 bps.

Ensure NTCIP components support NTCIP 2102 and NTCIP 2104.

NTCIP Components may support additional Subnet Profiles at the manufacturer's option. At any one time, make certain only one Subnet Profile is active on a given serial port of the NTCIP Component. Ensure the NTCIP Component can be configured to allow the field technician to activate the desired Subnet Profile and provide a visual indication of the currently selected Subnet Profile.

2. Transport Level

Ensure each NTCIP Component complies with NTCIP 2201 and 2202.

NTCIP Components may support additional Transport Profiles at the manufacturer's option. Ensure Response datagrams use the same Transport Profile used in the request.

Ensure each NTCIP Component supports the receipt of datagrams conforming to any of the identified Transport Profiles at any time.

3. Application Level

Ensure each NTCIP Component complies with NTCIP 1101 and 2301 and meets the requirements for Conformance Level 1 (NOTE - See Amendment to standard).

Ensure each NTCIP Component supports SNMP traps. An NTCIP Component may support additional Application Profiles at the manufacturer's option. Ensure Responses use the same Application Profile used by the request. Ensure each NTCIP Component supports the receipt of Application data packets at any time allowed by the subject standards.

4. Information Level

Guarantee each NTCIP Component provides Full, Standardized Object Range Support of all objects required by these Special Provisions unless otherwise indicated below. Make certain the maximum Response Time for any object or group of objects is 200 milliseconds.

Design the DMS to support all mandatory objects of all mandatory Conformance Groups as defined in NTCIP 1201 and NTCIP 1203. Table 2 indicates the modified object requirements for these mandatory objects.

Table 2: Modified Object Ranges for Mandatory Objects

Object	Reference	Project Requirement
ModuleTableEntry	NTCIP 1201 Clause 2.2.3	Contains at least one row with moduleType equal to 3 (software). The moduleMake specifies the name of the manufacturer, the moduleModel specifies the manufacturer's name of the component and the modelVersion indicates the model version number of the component.
MaxGroupAddresses	NTCIP 1201 Clause 2.7.1	At least 1
CommunityNamesMax	NTCIP 1201 Clause 2.8.2	At least 3
DmsNumPermanentMsg	NTCIP 1203 Clause 2.6.1.1.1.1	At least 1*
DmsMaxChangeableMsg	NTCIP 1203 Clause 2.6.1.1.1.3	At least 21

DmsFreeChangeableMemory	NTCIP 1203 Clause 2.6.1.1.1.4	At least 20 when no messages are stored.
DmsMessageMultiString	NTCIP 1203 Clause 2.6.1.1.1.8.3	The DMS supports any valid MULTI string containing any subset of those MULTI tags listed in Table 4
DmsControlMode	NTCIP 1203 Clause 2.7.1.1.1.1	Support at least the following modes: Local External central CentralOverride

* Ensure the Permanent Messages display the content shown in Table 3.

Ensure the sign blanks if a command to display a message contains an invalid Message CRC value for the desired message.

Table 3: Content of Permanent Messages

Perm. Msg. Num.	<u>Description</u>
1	Permanent Message #1 blanks the display (i.e., consist of and empty MULTI string). It has a run-time priority of one (1).

Table 4: Required MULTI Tags

Code	Feature
f1	field 1 - time (12hr)
f2	field 2 - time (24hr)
f8	field 8 – day of month
f9	field 9 – month
f10	field 10 - 2 digit year
f11	field 11 - 4 digit year
fl (and /fl)	flashing text on a line by line basis with flash rates controllable in 0.5 second increments.
fo	Font

j12	Justification – line – left
j13	Justification – line – center
j14	Justification – line – right
j15	Justification – line – full
jp2	Justification – page – top
jp3	Justification – page – middle
jp4	Justification – page – bottom
Mv	moving text
Nl	new line
Np	new page, up to 2 instances in a message (i.e., up to 3 pages/frames in a message counting first page)
Pt	page times controllable in 0.5 second increments.

The NTCIP Component implements all mandatory and optional objects of the following optional conformance groups with FSORS.

5. Test Heading

i. Time Management

As defined in NTCIP 1201

ii. Timebase Event Schedule

As defined in NTCIP 1201. The following list indicates the modified object requirements for this conformance group.

Table 5: Modified Object Ranges for the Timebase Event Schedule Conformance Group

Object	Reference	Project Requirement
MaxTimeBaseScheduleEntries	NTCIP 1201 Clause 2.4.3.1	At least 28
maxDayPlans	NTCIP 1201 Clause 2.4.4.1	At least 14
maxDayPlanEvents	NTCIP 1201 Clause 2.4.4.2	At least 10

iii. Report

As defined in NTCIP 1201. The following list indicates the modified object requirements for this conformance group.

Table 6: Modified Object Ranges for the Report Conformance Group

Object	Reference	Project Requirement
maxEventLogConfigs	NTCIP 1201 Clause 2.5.1	At least 50
eventConfigurationMode	NTCIP 1201 Clause 2.4.3.1	The NTCIP Component supports the following Event Configuration Modes: onChange greaterThanValue smallerThanValue
MaxEventLogSize	NTCIP 1201 Clause 2.5.3	At least 200
MaxEventClasses	NTCIP 1201 Clause 2.5.5	At least 16

iv. PMPP

v. Font Configuration

As defined in NTCIP 1203. The following list indicates the modified object requirements for this conformance group.

Table 7: Modified Object Ranges for the Font Configuration Conformance Group

Object	Reference	Project Requirement
NumFonts	NTCIP 1203 Clause 2.4.1.1.1.1	At least 4*
MaxFontCharacters	NTCIP 1203 Clause 2.4.1.1.1.3	At least 127**

*Upon delivery, the first font is a standard 18" font. The second font is a double-stroke 18" font. The third font is a 28" font. The fourth font is empty.

**Upon delivery, the first three font sets are configured in accordance with the ASCII character set for the following characters:

- "A" thru "Z"- All upper case letters.
- "0" thru "9"- All decimal digits.
- Space (i.e., ASCII code 0x20).

- Punctuation marks shown in brackets [. , ! ? - ‘ ’ “ ” / ()]
- Special characters shown in brackets [# & * +<>]

vi. **DMS Configuration**

As defined in NTCIP 1203.

vii. **MULTI Configuration**

As defined in NTCIP 1203. The following list indicates the modified object requirements for this conformance group.

Table 8: Modified Object Ranges for the MULTI Configuration Conformance Group

Object	Reference	Project Requirement
DefaultBackgroundColor	NTCIP 1203 Clause 2.5.1.1.1.1	The DMS supports the following background colors: black
DefaultForegroundColor	NTCIP 1203 Clause 2.5.1.1.1.2	The DMS supports the following foreground colors: amber
DefaultJustificationLine	NTCIP 1203 Clause 2.5.1.1.1.6	The DMS supports the following forms of line justification: left center right full
defaultJustificationPage	NTCIP 1203 Clause 2.5.1.1.1.7	The DMS supports the following forms of page justification: top middle bottom
defaultPageOnTime	NTCIP 1203 Clause 2.5.1.1.1.8	The DMS supports the full range of these objects with step sizes no larger than 0.5 seconds
defaultPageOffTime	NTCIP 1203 Clause 2.5.1.1.1.9	The DMS supports the full range of these objects with step sizes no larger than 0.5 seconds

defaultCharacterSet	NTCIP 1203 Clause 2.5.1.1.1.10	The DMS supports the following character sets: eightBit
---------------------	-----------------------------------	--

viii. **Default Message Control** as defined in NTCIP 1203

ix. **Pixel Service Control** as defined in NTCIP 1203

x. **MULTI Error Control** as defined in NTCIP 1203

xi. **Illumination / Brightness Control**

As defined in NTCIP 1203. The following list indicates the modified object requirements for this conformance group.

Table 9: Modified Object Ranges for the Illumination / Brightness Control Conformance Group

Object	Reference	Project Requirement
dmsIllumControl	NTCIP 1203 Clause 2.8.1.1.1.1	The DMS supports the following illumination control modes: photocell timer manual
dmsIllumNumBrightLevels	NTCIP 1203 Clause 2.8.1.1.1.4	At least 16

xii. **Auxiliary I/O**

xiii. **Scheduling**

As defined in NTCIP 1203. The following list indicates the modified object requirements for this conformance group.

Table 10: Modified Object Ranges for the Scheduling Conformance Group

Object	Reference	Project Requirement
NumActionTableEntries	NTCIP 1203 Clause 2.9.1.1.1.1	At least 21

xiv. **Sign Status** as defined in NTCIP 1203

xv. **Status Error as defined in NTCIP 1203**

xvi. **Pixel Error Status as defined in NTCIP 1203**

xvii. **Fan Error Status as defined in NTCIP 1203**

xviii. **Power Status as defined in NTCIP 1203**

xix. **Temperature Status as defined in NTCIP 1203**

Install necessary hardware for the support of items q, r, and s above.

Table 11: Some Optional Object Requirements

Object	Reference	Project Requirement
DefaultFlashOn	NTCIP 1203 Clause 2.5.1.1.1.3	The DMS supports the full range of these objects with step sizes no larger than 0.5 seconds
DefaultFlashOff	NTCIP 1203 Clause 2.5.1.1.1.4	The DMS supports the full range of these objects with step sizes no larger than 0.5 seconds
DmsMultiOtherErrorDescription	NTCIP 1203 Clause 2.7.1.1.1.20	If the vendor implements any vendor-specific MULTI tags, the DMS shall provide meaningful error messages within this object whenever one of these tags generates an error.

6. Documentation

Supply software with full documentation, including a CD-ROM containing ASCII versions of the following MIB files in Abstract Syntax Notation 1 (ASN.1) format:

- The relevant version of each official standard MIB Module referenced by the device functionality.
- If the device does not support the full range of any given object within a Standard MIB Module, a manufacturer specific version of the official Standard MIB Module with the supported range indicated in ASN.1 format in the SYNTAX and / or DESCRIPTION fields of the associated OBJECT TYPE macro. Name this file identical to the standard MIB Module, except that it will have the extension ".man".

- A MIB Module in ASN.1 format containing any and all manufacturer-specific objects supported by the device with accurate and meaningful DESCRIPTION fields and supported ranges indicated in the SYNTAX field of the OBJECT-TYPE macros.
- A MIB containing any other objects supported by the device.

Allow the use of any and all of this documentation by any party authorized by the Department for systems integration purposes at any time initially or in the future, regardless of what parties are involved in the systems integration effort.

C. NTCIP Acceptance Testing

Test the NTCIP requirements outlined above by a third party testing firm. Submit to the Engineer for approval a portfolio of the selected firm. Include the name, address, and a history of the selected firm in performing NTCIP testing along with references. Also provide a contact person's name and phone number. Submit detailed NTCIP testing plans and procedures, including a list of hardware and software, to the Engineer for review and approval 10 days in advance of a scheduled testing date. Develop test documents based on the NTCIP requirements of these Project Special Provisions. The acceptance test will use the NTCIP Exerciser, and / or other authorized testing tools and will follow the guidelines established in the ENTERPRISE Test Procedures. Conduct the test in North Carolina on the installed system in the presence of the Engineer. Document and certify the results of the test by the firm conducting the test and submit the Engineer for review and approval. In case of failures, remedy the problem and have the firm retest in North Carolina. Continue process until all failures are resolved. The Department reserves the right to enhance these tests as deemed appropriate to ensure device compliance.

V. DMS Testing Requirements

General Test Procedure

Test the DMS system in a series of design approval and functional tests. The results of each test must meet the specified requirements. These tests should not damage the equipment. The Engineer will reject equipment that fails to fulfill the requirements of any test. Resubmit rejected equipment after correcting non-conformities and re-testing; completely document all diagnoses and corrective actions. Modify all equipment furnished under this contract, without additional cost to the North Carolina Department of Transportation, to incorporate all design changes necessary to pass the required tests.

Provide 4 copies of all test procedures and requirements to the Engineer for review and approval at least 30 days prior to the testing start date.

Only use approved procedures for the tests. Include the following in the test procedures:

- A step-by-step outline of the test sequence, showing a test of every function of the equipment or system tested

- A description of the expected nominal operation, output, and test results, and the pass / fail criteria
- An estimate of the test duration and a proposed test schedule
- A data form to record all data and quantitative results obtained during the test
- A description of any special equipment, setup, manpower, or conditions required by the test

Provide all necessary test equipment and technical support. Use test equipment calibrated to National Institute of Standards and Technology (NIST) standards. Provide calibration documentation upon request.

Conform to these testing requirements and the requirements of these specifications. The Engineer will reject all equipment not tested according to these requirements. It is the Design-Build Team's responsibility to ensure the DMS system functions properly even after the Engineer accepts the DMS test results.

Provide 4 copies of the quantitative test results and data forms containing all data taken, highlighting any non-conforming results and remedies taken, to the Engineer for approval. An authorized representative of the manufacturer must sign the test results and data forms.

Design Approval Tests

Design Approval Tests are applicable to DMS systems not currently on the QPL.

The Design Approval Tests consists of all tests described in Section 2.2 "DMS Equipment Tests" of NEMA TS 4-2005 (Hardware Standards for Dynamic Message Signs with NTCIP Requirements). Perform all tests and submit certified results for review and approval.

PROTOTYPE – Manufacture a prototype DMS and controller of the type and size described in the Project Special Provisions. In the presence of the Engineer, test the prototype according to the Design Approval and Operational Tests. When all corrections and changes (if any) have been made, the Department may accept the prototype DMS and controller as the physical and functional standard for the system furnished under this contract. The Design-Build Team may use the prototype units on this project if, after inspection and rework (if necessary), they meet all physical and functional specifications. In the case of standard product line equipment, if the Design-Build Team can provide test results certified by an independent testing facility as evidence of prior completion of successful design approval tests, then the Engineer may choose to waive these tests.

In each Design Approval Test, successfully perform the Functional Tests described below. Apply the extreme conditions to all associated equipment unless stated otherwise in these Project Special Provisions.

Operational Field Test (On-Site Commissioning)

Conduct an Operational Field Test of the DMS system installed on the project to exercise the normal operational functions of the equipment. The Operational Field Test will consist of the following tests as a minimum:

A. Physical Examination

Examine each piece of equipment to verify that the materials, design, construction, markings, and workmanship comply with the mechanical, dimensional, and assembly requirements of these Project Special Provisions.

Perform the following tests as a minimum:

- Verify that all surfaces are free of dents, scratches, weld burns, or abrasions. Round sharp edges and corners.
- Verify bend radius of cables is not excessive or could potentially cause damage.
- Verify all modules, lamps, and components are properly secured.
- Verify that there are no exposed live terminals.

B. Continuity Tests

Check the wiring to assure it conforms to the requirements of these Project Special Provisions.

C. Functional Tests

Perform the following functional tests:

- Start-up and operate the DMS locally using a laptop computer.
- Use automatic (photo-electric sensor controlled) DMS Control Software to switch between “dim”, “normal”, and “bright” light levels.
- Operate the DMS with all display elements flashing continuously for 10 minutes at the maximum flash rate.
- Exercise the DMS by displaying static messages, flashing messages, and alternating static and flashing message sequences.
- Automatic poll the DMS by the Control Software at various intervals and verify the data received by Control Software from DMS.
- Download and edit messages using Control Software.
- Execute status request on the DMS controller.
- Observe normal operations during uploading and downloading messages.
- Input and select messages from the sign controller’s local user interface.
- Test sequence activation at chosen intervals.
- Display and verify all stored messages.
- Verify resumption of standard operation upon interruption of electrical power.
- Demonstrate detected failures and response functions.

- Demonstrate proper operation of the Failure Log.
- Set controller clock using the Control Software.
- Execute system shutdown using the Control Software and local user interface.
- Verify detection of a power failure in the DMS enclosure and the report feature of the failure to the Control Software.

Approval of Operational Field Test results does not relieve the Design-Build Team to conform to the requirements in these Project Special Provisions. If the DMS system does not pass these tests, document a correction or substitute a new unit as approved by the Engineer. Re-test the system until it passes all requirements.

30-Day Observation Period

The 30-Day Observation Period is part of work to be completed by the project completion date.

Upon successful completion of all project work, the component tests, the System Test, and the correction of all deficiencies, including minor construction items, the 30-day Observation Period may commence. This observation consists of a 30-day period of normal, day-to-day operations of the new field equipment in operation with the new central equipment without any failures. The purpose of this period is to ensure that all components of the system function in accordance with the plans developed by the Design-Build Team and these Project Special Provisions.

Respond to system or component failures (or reported failures) that occur during the 30-day Observation Period within twenty-four (24) hours. Correct said failures within forty-eight (48) hours. Any failure that affects a major system component as defined below for more than forty-eight (48) hours will suspend the timing of the 30-day Observation Period beginning at the time when the failure occurred. After the cause of such failures has been corrected, timing of the 30-day Observation Period will resume. System or component failures that necessitate a redesign of any component or failure in any of the major system components exceeding a total of three (3) occurrences will terminate the 30-day Observation Period and cause the 30-day Observation Period to be restarted from day zero when the redesigned components have been installed and / or the failures corrected. The major system components are:

- DMS Field Controller
- DMS Display Module
- DMS Workstation Software

VI. DMS Assemblies

Description

This section includes all design, fabrication, furnishing, and erection of the DMS assemblies, DMS mounting assemblies, maintenance platforms, and ladder attachment for access to the DMS inspection doors, and attachment of the DMS enclosures to the structures in accordance with the requirements of these Project Special Provisions and the plans developed by the Design-Build Team. Fabricate the supporting DMS assemblies from tubular steel. Furnish pedestal or

overhead type DMS assemblies as shown in the plans developed by the Design-Build Team. Design the overhead structure with a 4-chord (box) truss system. Cantilevered and Monotube (horizontal truss) DMS structures will not be allowed.

Provide pedestal type DMS assembly structures with a minimum of 25 feet and overhead structures with a minimum of 20 feet clearance from the high point of the road to the bottom of the DMS enclosure.

Design the DMS assemblies (including footings), DMS mounting assemblies, maintenance platforms, and access ladders and submit shop drawings to the Engineer for acceptance. A Professional Engineer that is registered in the state of North Carolina will prepare such computations and drawings. These must bear his signature, seal, and date of acceptance.

The provisions of Section 900 of the Standard Specifications apply to all work covered by this section.

It is the Design-Build Team's responsibility to provide DMS S-Dimension elevation drawings to the Engineer for approval.

Material

Use materials that meet the following requirements of the Standard Specifications:

Structural Steel	Section 1072
Overhead Sign Structures	Section 1096
Signing Materials	Section 1092
Organic-Zinc Repair Paint	Article 1080-9
Reinforcing Steel	Sub-article 1070
Direct Tension Indicators	Sections 440 and 1072

Construction Methods

A. General

Fabricate the new DMS assemblies, DMS mounting assemblies, maintenance platforms, and access ladders in accordance with the details shown in the approved shop drawings and the requirements of these Project Special Provisions.

No welding, cutting, or drilling in any manner will be permitted in the field, unless approved by the Engineer.

Drill bolt holes and slots to finished size. Holes may also be punched to finished size, provided the diameter of the punched holes is at least twice the thickness of the metal being punched. Flame cutting of bolt holes and slots is not permitted.

Erect DMS in accordance with the requirements indicated on the plans developed by the Design-Build Team and in these Project Special Provisions. Field drill two holes per connection in the Z bars for attaching the DMS to the structure. Use two bolts at each connection. Provide two (2) U-bolts at each U-bolt connection such as 1) each truss chord

to sign hanger, or 2) each truss chord to platform support. Provide two (2) U-bolts at each U-bolts connection where ends of truss chords are supported. Minimum diameter of all U-bolts is to be ½-inch.

Use two coats of a zinc-rich paint to touch up minor scars on all galvanized materials. See Standard Specifications for Roads and Structures Section 1076-7.

For high strength bolted connections, provide direct tension indicator washers.

B. Shop Drawing

Submit to the Engineer for approval a complete design for the DMS assemblies (including footings), DMS mounting assemblies, maintenance platforms, access ladders, DMS assembly hardware, brackets for supporting the DMS and maintenance platforms. Base the design on the line drawings and correct wind speed in accordance with the latest edition of AASHTO "Standard Specifications for Structural Supports for Highway Signs, Luminaries and Traffic Signals, 5th Edition, 2009, with 2010 and 2011 Interim Revisions."

The manufacturer of the DMS assembly must ensure that design of the assembly is compatible with the DMSs for mounting and attachment.

Submit six copies of complete detailed shop drawings and one copy of the design computations for the DMS assembly to the Engineer for approval prior to fabrication. Show in the shop drawings complete design and fabrication details including foundations, provisions for attaching the DMS, maintenance platform and access ladders to supporting structures, applicable material specifications, and any other information necessary for procuring and replacing any part of the complete DMS assembly.

Allow a minimum of 20 working days for shop drawing approval after the Engineer receives them. If revised drawings are necessary, allow appropriate additional time for review and approval of final shop drawings.

Approval of shop drawings by the Engineer will not relieve the Design-Build Team of his responsibility for the correctness of drawings, or for the fit of all shop and field connections and anchors.

C. Design and Fabrication

The wind drag coefficient for Dynamic Message Sign enclosures shall be 1.7.

For all U-bolt connections of hanger beams to overhead assembly truss chords, provide all U-bolts with a flat washer, a lock washer and double nuts at each end of the U-bolts. All double nuts that are on any U-bolt shall be the same thickness and weight. When assembled, the double nuts shall be brought tight against each other by the use of two wrenches.

For additional design and fabrication requirements, reference the Overhead Sign Supports Project Special Provision.

1. DMS Maintenance Platform (Walkway)

Provide a maintenance platform, a minimum of three feet wide with open skid-resistant surface and safety railing on the DMS assemblies for access to the DMS inspection door. Provide platforms with fixed safety railings along both sides from the beginning of the platform to the inspection door.

Ensure the design, fabrication and installation of the access platforms on new DMS structures complies with the following:

1. The top of the platform grading surface is vertically aligned with the bottom of the DMS door. Ensure the platform extends from the DMS enclosure to the access ladder.
2. The DMS door will open 90-degrees from its closed position without any obstruction from the platform or safety handrails.
3. The platform is rigidly and directly connected to the walkway brackets and there is no uneven surface between sections.
4. Install a 4" x 4" safety angle parallel to and along both sides of the platform and extend it the entire length of the platform. Design the safety angle to withstand loading equivalent to the platform.
5. Ensure the platform design allows full access to the DMS enclosure inspection door with no interference or obstructions.

2. DMS Access Ladder

Provide a fixed ladder, of the same material as the pedestal structures, leading to and ending at the access platform. Equip the ladder with a security cover (ladder guard) and lock to prohibit access by unauthorized persons. Design the rungs on 12-inch center to center typical spacing. The first ladder rung no more than 18 inches above the landing pad. Attach the security cover approximately 6 feet above the finished ground. Design the ladder and security cover as a permanent part of the DMS assembly and include complete design details in the DMS assembly shop drawings. Fabricate the ladder and cover to meet all OSHA requirements and applicable state and local codes, including but not limited to providing a ladder cage.

Furnish and install a level concrete pad a minimum of 4 inches deep, 24 inches wide, and 36 inches long to service as a landing pad for accessing the ladder. Design the landing pad to be directly below the bottom rung. Access to the ladder shall not be obstructed by the DMS foundation. Provide pre-formed or cast-in place concrete pads.

3. Foundations and Anchor Rod Assemblies

For foundation and anchor rod assembly requirements reference the Foundation and Anchor Rod Assemblies for Metal Poles and Overhead and Dynamic Message Sign Foundations Project Special Provisions.

CCTV FIELD EQUIPMENT

(07-24-13)

I. Description

Furnish and install CCTV field equipment described in these Project Special Provisions. Furnish equipment that is compatible, interoperable, and completely interchangeable with existing high-performance dome equipment currently in use by NCDOT in this Region. Ensure that the equipment is fully compatible with all features of the existing *VideoPro* video management software currently in use by NCDOT in this Region.

II. Material

General

Furnish and install new CCTV camera assemblies at the locations shown on the plans developed by the Design-Build Team. Each assembly consists of the following:

- One Dome CCTV camera that contains in a single enclosed unit the following functionality and accessories:
 1. CCTV color digital signal processing camera unit with zoom lens, filter, control circuit, and accessories
 2. Motorized pan, tilt, and zoom
 3. Pole-mount camera attachment assembly
 4. All necessary cable, connectors and incidental hardware to make a complete and operable system
- A lightning arrestor installed in-line between the CCTV camera and the equipment cabinet components.
- A NEMA Type 4 enclosure constructed of aluminum with a clear acrylic dome or approved equal Camera Unit housing.

Camera and Lens

1. Cameras

Furnish new charged-coupled device (CCD) color cameras. Furnish cameras with automatic gain control (AGC) for clear images in varying light levels. The camera must meet the following minimum requirements:

- Video signal format: NTSC composite color video output, 1 volt peak to peak
- Automatic Gain Control (AGC): 0-20 dB, peak-average adjustable
- Automatic focus: Automatic with manual override
- White balance: Automatic through the lens with manual override
- Electronic-Shutter: dip-switch selectable electronic shutter with speed range from 1/60 of a second (off) to 1/30,000th of a second

- Overexposure protection: The camera must have built-in circuitry or a protection device to prevent any damage to the camera when pointed at strong light sources, including the sun
- Sensitivity: 1.5 lux at 90% scene reflectance
- Signal to noise ratio: Greater than 48-dB
- Video output Connection: 1-volt peak to peak, 75 ohms terminated, BNC connector
- Power: 24 VAC or less

2. Zoom Lens

Furnish each camera with a motorized zoom lens that is high performance integrated dome system or approved equivalent with automatic iris control with manual override and neutral density spot filter. Furnish lenses that meet the following optical specifications:

- Focal length: 0.16” – 3.45”, 35X optical zoom, and 12X electronic zoom
- Preset positioning: 64 Presets

The lens must be capable of both automatic and remote manual control iris and focus override operation. The lens must be equipped for remote control of zoom and focus, including automatic movement to any of the preset zoom and focus positions. Mechanical or electrical means must be provided to protect the motors from overrunning in extreme positions. The operating voltages of the lens must be compatible with the outputs of the camera control.

Camera Housing

Furnish new dome style enclosure for the CCTV assemblies. Equip each housing with mounting assembly for attachment to the CCTV camera pole. The enclosures must be equipped with a sunshield and be fabricated from corrosion resistant aluminum and finished in a neutral color of weather resistant enamel. The enclosure must meet or exceed NEMA 4X ratings. The viewing area of the enclosure must be tempered glass.

Pan and Tilt Unit

Equip each new dome style assembly with a pan and tilt unit. The pan and tilt unit must be integral to the high performance integrated dome system. The pan and tilt unit must be rated for outdoor operation, provide dynamic braking for instantaneous stopping, prevent drift, and have minimum backlash. The pan and tilt units must meet or exceed the following specifications:

- Pan: continuous 360 Degrees
- Tilt: up / down 180 degrees minimum
- Input voltage: 24 VAC 50/60Hz
- Motors: Two-phase induction type, continuous duty, instantaneous reversing

- Preset Positioning: 64 PTZ presets per camera

Control Receiver/Driver

Provide each new camera unit with a control receiver / driver that is integral to the CCTV dome assembly. The control receiver / driver will receive serial asynchronous data initiated from a camera control unit, decode the command data, perform error checking, and drive the pan/tilt unit, camera controls, and motorized lens. As a minimum, the control receiver/drivers must provide the following functions:

- Zoom in / out
- Automatic focus with manual override
- Tilt up / down
- Automatic iris with manual override
- Pan right / left
- Minimum 64 preset positions for pan, tilt, and zoom

In addition, each control receiver / driver must accept status information from the pan / tilt unit and motorized lens for preset positioning of those components. The control receiver / driver will relay pan, tilt, zoom, and focus positions from the field to the remote camera control unit. The control receiver / driver must accept “goto” preset commands from the camera control unit, decode the command data, perform error checking, and drive the pan/tilt and motorized zoom lens to the correct preset position. The preset commands from the camera control unit will consist of unique values for the desired pan, tilt, zoom, and focus positions.

CCTV Camera Attachment to Pole

Install on CCTVs on new wood poles, furnish an attachment assembly for the CCTV camera unit. Use stainless steel banding approved by the Engineer. Submit shop drawings for review and approval by the Engineer prior to installation.

Furnish CCTV attachments that allow for the removal and replacement of the CCTV enclosure as well as providing a weatherproof, weather tight, seal that does not allow moisture to enter the enclosure.

Furnish a CCTV Camera Attachment Assembly that is able to withstand wind loading at the maximum wind speed and gust factor called for in these Special Provisions and can support a minimum camera unit dead load of 45 pounds (20.4 kg).

Surge Suppression

Protect all equipment at the top of the pole grounded metal oxide varistors connecting each power conductor to ground.

Protect coaxial cable from each camera by a surge protector at each end of the cable.

Video Ethernet Encoder

Furnish and install a digital video Ethernet encoder to allow video-over-IP transmission. The encoder units may be shelf or rack mounted. For compatibility with existing Center and Field video equipment, furnish Verint model S1950e or approved equivalent encoders. Furnish encoders with the following features:

- Network Interface Ethernet 10/100Base-T (RJ-45 connector)
- Protocols RTP/IP, UDP/IP, TCP/IP, multicast IP DNS and DHCP client
- Security SSL-based authentication
- Video Output connector 1 composite (NTSC/PAL), 1 Vpp, 75 ohms, BNC
- Compression MPEG-4
- Resolution Scalable; 176x128 to 704x480 NTSC (176x144 to 704x576 PAL)
- Frame Rate 1-30 FPS programmable (full motion)
- Bandwidth 30 kbps – 6 Mbps configurable
- Serial Ports 1 RS-232, 1 RS-422/485; Supports any asynchronous PTZ serial protocol
- Environment 32°F to 122°F, 95% non-condensing humidity at 122°F
- Connectors 5 position terminal strip

III. Construction Methods

General

Mount CCTV camera units at a height sufficient to adequately see traffic in all directions and as approved by the Engineer. The maximum attachment height is 45 feet above ground level.

Mount the CCTV camera units such that a minimum 5 feet of clearance is maintained between the camera and the top of the pole.

Obtain approval of the camera locations and orientation from the Engineer prior to installing the CCTV camera assemblies.

Mount CCTV cameras on the side of poles nearest intended field of view. Avoid occluding the view with the pole.

Video Ethernet Encoder

Install and integrate the video Ethernet encoder at the CCTV camera site shown in the Plans. Connect the video output of the CCTV camera to the input of the video encoder. Use standard coax cable with BNC (gold-plated center pin) connectors. Connect the PTZ control wires from the camera to the video encoder in accordance with manufacturer's recommended instructions.

Electrical and Mechanical Requirements

Ground all equipment as called for in the Standard Specifications, these Special Provisions, and the plans developed by the Design-Build Team.

Install surge protectors on all ungrounded conductors entering the CCTV enclosure. House the protectors in a small, ventilated weatherproof cabinet attached near the CCTV attachment point in a manner approved by the Engineer.

IV. CCTV Field Equipment Cabinet

Description

Furnish 336 pole mounted cabinets to house CCTV control and transmission equipment. The cabinets must consist of a cabinet housing, 19-inch EIA mounting cage, and power distribution assembly (PDA #3 as described in the CALTRANS TSCES).

The cabinet housing must conform to sections 6.2.2 (Housing Construction), 6.2.3 (Door Latches and Locks), 6.2.4 (Housing Ventilation), and 6.2.5 (Hinges and Door Catches) of the CALTRANS TSCES. Do not equip the cabinet housings with a police panel.

The cabinet cage must conform to section 6.3 of the CALTRANS TSCES.

Terminal blocks on the PDA #3 Assembly have internal wiring for the Model 200 switch pack sockets. Do not use terminal blocks on PDA #3 as power terminals for cabinet devices. Do not furnish cabinet with "Input Panels" described in section 6.4.7.1 of the TSCES. Do furnish cabinet with "Service Panels" as described in section 6.4.7.1 of the TSCES and as depicted on drawing TSCES-9 in the TSCES. Use service panel #2.

Furnish terminal blocks for power for cabinet CCTV and communications devices as needed to accommodate the number of devices in the cabinet.

Do not furnish cabinets with C1, C5, or C6 harness, input file, output file, monitor units, model 208 unit, model 430 unit, or switch packs.

Furnish all conduits, shelving, mounting adapters, and other equipment as necessary to route cabling, mount equipment, and terminate conduit in equipment cabinet.

Material

1. Shelf Drawer

Provide a pull out, hinged-top drawer, having sliding tracks, with lockout and quick disconnect feature in the equipment cabinet. Furnish a pullout drawer that extends a minimum of 14 inches that is capable of being lifted to gain access to the interior of the drawer. Minimum interior dimensions of the drawer are to be 1 inch high, 13 inches deep and 16 inches wide. Provide drawers capable of supporting a 40-pound device or component when fully extended.

2. Cabinet Light

Each cabinet must include two (2) fluorescent lighting fixtures (one front, one back) mounted horizontally inside the top portion of the cabinet. The fixtures must include a cool white lamp, and must be operated by normal power factor UL-listed ballast. A door-actuated switch must be installed to turn on the applicable cabinet light when the front door or back door is opened. The lights must be mounted not to interfere with the upper door stay.

3. Surge Protection for System Equipment

Each cabinet must be provided with devices to protect the CCTV and communications equipment from electrical surges and over voltages as described below.

4. Main AC Power Input

Each cabinet must be provided with a hybrid-type, power line surge protection device mounted inside the power distribution assembly. The protector must be installed between the applied line voltage and earth ground. The surge protector must be capable of reducing the effect of lightning transient voltages applied to the AC line. The protector must be mounted inside the Power Distribution Assembly housing facing the rear of the cabinet. The protector must include the following features and functions:

- Maximum AC line voltage: 140 VAC.
- Twenty pulses of peak current, each of which must rise in 8 microseconds and fall in 20 microseconds to ½ the peak: 20000 Amperes.
- The protector must be provided with the following terminals:
 - Main Line (AC Line first stage terminal).
 - Main Neutral (AC Neutral input terminal).
 - Equipment Line Out (AC line second state output terminal, 19 amps).
 - Equipment Neutral Out (Neutral terminal to protected equipment).
 - GND (Earth connection).

- The Main AC line in and the Equipment Line out terminals must be separated by a 200 Microhenry (minimum) inductor rated to handle 10 AMP AC Service.
- The first stage clamp must be between Main Line and Ground terminals.
- The second stage clamp must be between Equipment Line Out and Equipment Neutral.
- The protector for the first and second stage clamp must have an MOV or similar solid state device rated at 20 KA and must be of a completely solid state design (i.e., no gas discharge tubes allowed).
- The Main Neutral and Equipment Neutral Out must be connected together internally and must have an MOV similar solid state device or gas discharge tube rated at 20 KA between Main Neutral and Ground terminals.
- Peak Clamp Voltage: 350 volts at 20 KA. (Voltage measured between Equipment Line Out and Equipment Neutral Out terminals. Current applied between Main Line and Ground Terminals with Ground and Main Neutral terminals externally tied together).
- Voltage must never exceed 350 volts.
- The Protector must be epoxy-encapsulated in a flame-retardant material.
- Continuous service current: 10 Amps at 120 VAC RMS.
- The Equipment Line Out must provide power to cabinet CCTV and communications equipment and to the 24V power supply.

5. Ground Bus

Provide a neutral bus that is not connected to the earth ground or the logic ground anywhere within the cabinet. Ensure that the earth ground bus and the neutral ground bus each have ten compression type terminals, each of which can accommodate wires ranging from number 14 through number 4 AWG.

6. Uninterruptible Power Supply (UPS)

Furnish and install one rack mounted UPS in each new cabinet that meet the following minimum specifications:

Output

Output Power Capacity	480 Watts / 750 VA
Max Configurable Power	480 Watts / 750 VA
Nominal Output Voltage	120V
Output Voltage Distortion	Less than 5% at full load
Output Frequency (sync to mains)	57 - 63 Hz for 60 Hz nominal
Crest Factor	up to 5:1
Waveform Type	Sine wave

Output Connections	(4) NEMA 5-15R
Input	
Nominal Input Voltage	120V
Input Frequency	50/60 Hz +/- 3 Hz (auto sensing)
Input Connections	NEMA 5-15P
Cord Length	6 feet
Input voltage range for main operations	82 - 144V
Input voltage adjustable range for mains operation	75 -154 V

Battery Type

Maintenance-free sealed Lead-Acid battery with suspended electrolyte, leak-proof.

Typical recharge time	2 hours
-----------------------	---------

Communications & Management

Interface Port(s)	DB-9 RS-232, USB
Control panel	LED status display with load and battery bar-graphs

Surge Protection and Filtering

Surge energy rating	480 Joules
---------------------	------------

Environmental

Operating Environment	32 - 104 °F
Operating Relative Humidity	0 - 95%
Storage Temperature	5 - 113 °F
Storage Relative Humidity	0 - 95%

Conformance

Regulatory Approvals	FCC Part 15 Class A,UL 1778
----------------------	-----------------------------

V. Construction Methods

For each field equipment cabinet installation, use stainless steel banding or other method approved by the Engineer to fasten cabinet to pole. Install field equipment cabinets so that the height to the middle of the enclosure is 4 feet from ground level. No risers shall enter the top or sides of the equipment cabinet.

Install all conduits, condulets, and attachments to equipment cabinets in a manner that preserves the minimum bending radius of cables and creates water proof connections and seals.

Install a UPS in each cabinet and power all CCTV cameras from the UPS.

FOUNDATIONS AND ANCHOR ROD ASSEMBLIES FOR METAL POLES

3/26/13

DB9 R05

Description

Foundations for metal poles include foundations for signals, cameras, overhead and dynamic message signs (DMS) and high mount and low level light standards supported by metal poles or upright trusses. Foundations consist of footings with pedestals and drilled piers with or without grade beams or wings. Anchor rod assemblies consist of anchor rods (also called anchor bolts) with nuts and washers on the exposed ends of rods and nuts and a plate or washers on the other ends of rods embedded in the foundation.

Construct concrete foundations with the required resistances and dimensions and install anchor rod assemblies in accordance with the contract and accepted submittals. Construct drilled piers consisting of cast-in-place reinforced concrete cylindrical sections in excavated holes. Provide temporary casings or polymer slurry as needed to stabilize drilled pier excavations. Use a prequalified Drilled Pier Contractor to construct drilled piers for metal poles. Define "excavation" and "hole" as a drilled pier excavation and "pier" as a drilled pier.

This provision does not apply to materials and anchor rod assemblies for standard foundations for low level light standards. See Section 1405 of the 2012 *Standard Specifications for Roads and Structures* and *Roadway Standard Drawings* No. 1405.01 for materials and anchor rod assemblies for standard foundations. For construction of standard foundations for low level light standards, standard foundations are considered footings in this provision. This provision does not apply to foundations for signal pedestals; see Section 1743 of the 2012 *Standard Specifications for Roads and Structures* and *Roadway Standard Drawings* No. 1743.01.

Materials

Refer to the 2012 *Standard Specifications for Roads and Structures*.

Item	Section
Conduit	1091-3
Grout, Nonshrink	1003
Polymer Slurry	411-2(B)
Portland Cement Concrete	1000
Reinforcing Steel	1070
Rollers and Chairs	411-2(C)
Temporary Casings	411-2(A)

Provide Type 3 material certifications in accordance with Article 106-3 of the 2012 *Standard Specifications for Roads and Structures* for conduit, rollers, chairs and anchor rod assemblies. Store steel materials on blocking at least 12" above the ground and protect it at all times from damage; and when placing in the work make sure it is free from dirt, dust, loose mill scale, loose rust, paint, oil or other foreign materials. Load, transport, unload and store foundation and anchor rod assembly materials so materials are kept clean and free of damage. Bent, damaged or defective materials will be rejected.

Use conduit type in accordance with the contract. Use Class A concrete for footings and pedestals, Class Drilled Pier concrete for drilled piers and Class AA concrete for grade beams

and wings including portions of drilled piers above bottom of wings elevations. Corrugated temporary casings may be accepted at the discretion of the Engineer. A list of approved polymer slurry products is available from:

connect.ncdot.gov/resources/Geological/Pages/Products.aspx

Provide anchor rod assemblies in accordance with the contract consisting of the following:

- (A) Straight anchor rods,
- (B) Heavy hex top and leveling nuts and flat washers on exposed ends of rods, and
- (C) Nuts and either flat plates or washers on the other ends of anchor rods embedded in foundations.

Do not use lock washers. Use steel anchor rods, nuts and washers that meet ASTM F1554 for Grade 55 rods and Grade A nuts. Use steel plates and washers embedded in concrete with a nominal thickness of at least 1/4". Galvanize anchor rods and exposed nuts and washers in accordance with Article 1076-4 of the 2012 *Standard Specifications for Roads and Structures*. It is not necessary to galvanize nuts, plates and washers embedded in concrete.

Construction Methods

Install the required size and number of conduits in foundations in accordance with the accepted plans developed by the Design-Build Team and accepted submittals. Construct top of piers, footings, pedestals, grade beams and wings flat, level and within 1" of elevations shown in the accepted plans or approved by the Engineer. Provide an Ordinary Surface finish in accordance with Subarticle 825-6(B) of the 2012 *Standard Specifications for Roads and Structures* for portions of foundations exposed above finished grade. Do not remove anchor bolt templates or pedestal or grade beam forms or erect metal poles or upright trusses onto foundations until concrete attains a compressive strength of at least 3,000 psi.

(A) Drilled Piers

Before starting drilled pier construction, hold a predrill meeting to discuss the installation, monitoring and inspection of the drilled piers. Schedule this meeting after the Drilled Pier Contractor has mobilized to the site. The Resident or Division Traffic Engineer, Contractor and Drilled Pier Contractor Superintendent will attend this predrill meeting.

Do not excavate holes, install piles or allow equipment wheel loads or vibrations within 20 feet of completed piers until 16 hours after Drilled Pier concrete reaches initial set.

Check for correct drilled pier alignment and location before beginning drilling. Check plumbness of holes frequently during drilling.

Construct drilled piers with the minimum required diameters shown in the accepted plans developed by the Design-Build Team. Install piers with tip elevations no higher than shown in the plans developed by the Design-Build Team or approved by the Engineer.

Excavate holes with equipment of the sizes required to construct drilled piers. Depending

on the subsurface conditions encountered, drilling through rock and boulders may be required. Do not use blasting for drilled pier excavations.

Contain and dispose of drilling spoils and waste concrete as directed and in accordance with Section 802 of the 2012 *Standard Specifications for Roads and Structures*. Drilling spoils consist of all materials and fluids removed from excavations.

If unstable, caving or sloughing materials are anticipated or encountered, stabilize holes with temporary casings and / or polymer slurry. Do not use telescoping temporary casings. If it becomes necessary to replace a temporary casing during drilling, backfill the excavation, insert a larger casing around the casing to be replaced or stabilize the excavation with polymer slurry before removing the temporary casing.

If temporary casings become stuck or the Design-Build Team proposes leaving casings in place, temporary casings should be installed against undisturbed material. Unless otherwise approved, do not leave temporary casings in place for mast arm poles and cantilever signs. The Engineer will determine if casings may remain in place. If the Design-Build Team proposes leaving temporary casings in place, do not begin drilling until a casing installation method is approved.

Use polymer slurry and additives to stabilize holes in accordance with the slurry manufacturer's recommendations. Provide mixing water and equipment suitable for polymer slurry. Maintain polymer slurry at all times so slurry meets Table 411-3 of the 2012 *Standard Specifications for Roads and Structures* except for sand content.

Define a "sample set" as slurry samples collected from mid-height and within 2 feet of the bottom of holes. Take sample sets from excavations to test polymer slurry immediately after filling holes with slurry, at least every 4 hours thereafter and immediately before placing concrete. Do not place Drilled Pier concrete until both slurry samples from an excavation meet the required polymer slurry properties. If any slurry test results do not meet the requirements, the Engineer may suspend drilling until both samples from a sample set meet the required slurry properties.

Remove soft and loose material from bottom of holes using augers to the satisfaction of the Engineer. Assemble rebar cages and place cages and Drilled Pier concrete in accordance with Subarticle 411-4(E) except for the following:

- (1) Inspections for tip resistance and bottom cleanliness are not required,
- (2) Temporary casings may remain in place if approved, and
- (3) Concrete placement may be paused near the top of pier elevations for anchor rod assembly installation and conduit placement or
- (4) If applicable, concrete placement may be stopped at bottom of grade beam or wing elevations for grade beam or wing construction.

If wet placement of concrete is anticipated or encountered, do not place Drilled Pier concrete until a concrete placement procedure is approved. If applicable, temporary

casings and fluids may be removed when concrete placement is paused or stopped in accordance with the exceptions above provided holes are stable. Remove contaminated concrete from exposed Drilled Pier concrete after removing casings and fluids. If holes are unstable, do not remove temporary casings until a procedure for placing anchor rod assemblies and conduit or constructing grade beams or wings is approved.

Use collars to extend drilled piers above finished grade. Remove collars after Drilled Pier concrete sets and round top edges of piers.

If drilled piers are questionable, pile integrity testing (PIT) and further investigation may be required in accordance with Article 411-5 of the 2012 *Standard Specifications for Roads and Structures*. A drilled pier will be considered defective in accordance with Subarticle 411-5(D) of the 2012 *Standard Specifications for Roads and Structures* and drilled pier acceptance is based in part on the criteria in Article 411-6 of the 2012 *Standard Specifications for Roads and Structures* except for the top of pier tolerances in Subarticle 411-6(C).

If a drilled pier is under further investigation, do not grout core holes, backfill around the pier or perform any work on the drilled pier until the Engineer accepts the pier. If the drilled pier is accepted, dewater and grout core holes and backfill around the pier with approved material to finished grade. If the Engineer determines a pier is unacceptable, remediation is required in accordance with Article 411-6 of the 2012 *Standard Specifications for Roads and Structures*. No extension of completion date or time will be allowed for remediation of unacceptable drilled piers or post repair testing.

Permanently embed a plate in or mark top of piers with the pier diameter and depth, size and number of vertical reinforcing bars and the minimum compressive strength of the concrete mix at 28 days.

(B) Footings, Pedestals, Grade Beams and Wings

Excavate as necessary for footings, grade beams and wings in accordance with the plans, accepted submittals and Section 410 of the 2012 *Standard Specifications for Roads and Structures*. If unstable, caving or sloughing materials are anticipated or encountered, shore foundation excavations as needed with an approved method. Notify the Engineer when foundation excavation is complete. Do not place concrete or reinforcing steel until excavation dimensions and foundation material are approved.

Construct cast-in-place reinforced concrete footings, pedestals, grade beams and wings with the dimensions shown in the plans and in accordance with Section 825 of the 2012 *Standard Specifications for Roads and Structures*. Use forms to construct portions of pedestals and grade beams protruding above finished grade. Provide a chamfer with a 3/4" horizontal width for pedestal and grade beam edges exposed above finished grade. Backfill and fill in accordance with Article 410-8 of the 2012 *Standard Specifications for Roads and Structures*. Proper compaction around footings and wings is critical for foundations to resist uplift and torsion forces. Place concrete against undisturbed soil and do not use forms for standard foundations for low level light standards.

(C) Anchor Rod Assemblies

Size anchor rods for design and the required projection above top of foundations. Determine required anchor rod projections from nut, washer and base plate thicknesses and the following:

- (1) Protrusion of 3 to 5 anchor rod threads above top nuts after tightening and
- (2) Distance of one nut thickness between top of foundations and bottom of leveling nuts.

Protect anchor rod threads from damage during storage and installation of anchor rod assemblies. Before placing anchor rods in foundations, turn nuts onto and off rods past leveling nut locations. Turn nuts with the effort of one workman using an ordinary wrench without a cheater bar. Report any thread damage to the Engineer that requires extra effort to turn nuts.

Arrange anchor rods symmetrically about center of base plate locations as shown in the plans. Set anchor rod elevations based on required projections above top of foundations. Securely brace and hold rods in the correct position, orientation and alignment with a steel template. Do not weld to reinforcing steel, temporary casings or anchor rods.

Install top and leveling (bottom) nuts, washers and the base plate for each anchor rod assembly in accordance with the following procedure:

- (1) Turn leveling nuts onto anchor rods to a distance of one nut thickness between the top of foundation and bottom of leveling nuts. Place washers over anchor rods on top of leveling nuts.
- (2) Determine if nuts are level using a flat rigid template on top of washers. If necessary, lower leveling nuts to level the template in all directions or if applicable, lower nuts to tilt the template so the metal pole or upright truss will lean as shown in the plans. If leveling nuts and washers are not in full contact with the template, replace washers with galvanized beveled washers.
- (3) Verify the distance between the foundation and leveling nuts is no more than one nut thickness.
- (4) Place base plate with metal pole or upright truss over anchor rods on top of washers. High mount luminaires may be attached before erecting metal poles but do not attach cables, mast arms or trusses to metal poles or upright trusses at this time.
- (5) Place washers over anchor rods on top of base plate. Lubricate top nut bearing surfaces and exposed anchor rod threads above washers with beeswax, paraffin or other approved lubricants.
- (6) Turn top nuts onto anchor rods. If nuts are not in full contact with washers or washers are not in full contact with the base plate, replace washers with

galvanized beveled washers.

- (7) Tighten top nuts to snug-tight with the full effort of one workman using a 12" wrench. Do not tighten any nut all at once. Turn top nuts in increments. Follow a star pattern cycling through each nut at least twice.
- (8) Repeat (7) for leveling nuts.
- (9) Replace washers above and below the base plate with galvanized beveled washers if the slope of any base plate face exceeds 1:20 (5%), any washer is not in firm contact with the base plate or any nut is not in firm contact with a washer. If any washers are replaced, repeat (7) and (8).
- (10) With top and leveling nuts snug-tight, mark each top nut on a corner at the intersection of 2 flats and a corresponding reference mark on the base plate. Mark top nuts and base plate with ink or paint that is not water-soluble. Use the turn-of-nut method for pretensioning. Do not pretension any nut all at once. Turn top nuts in increments for a total turn that meets the following nut rotation requirements:

NUT ROTATION REQUIREMENTS (Turn-of-Nut Pretensioning Method)	
Anchor Rod Diameter, inch	Requirement
$\leq 1 \frac{1}{2}$	1/3 turn (2 flats)
$> 1 \frac{1}{2}$	1/6 turn (1 flat)

Follow a star pattern cycling through each nut at least twice.

- (11) Ensure nuts, washers and base plates are in firm contact with each other for each anchor rod. Cables, mast arms and trusses may now be attached to metal poles and upright trusses.
- (12) Between 4 and 14 days after pretensioning top nuts, use a torque wrench calibrated within the last 12 months to check nuts in the presence of the Engineer. Completely erect mast arm poles and cantilever signs and attach any hardware before checking top nuts for these structures. Check that top nuts meet the following torque requirements:

TORQUE REQUIREMENTS	
Anchor Rod Diameter, inch	Requirement, ft-lb
7/8	180
1	270
1 1/8	380
1 1/4	420
≥ 1 1/2	600

If necessary, retighten top nuts in the presence of the Engineer with a calibrated torque wrench to within ± 10 ft-lb of the required torque. Do not overtighten top nuts.

- (13) Do not grout under base plate.

OVERHEAD SIGN SUPPORTS

(8-27-12)

DB11 R012

Description

Design, fabricate, furnish and erect various types of overhead sign assemblies. Fabricate supporting structures using tubular members of either aluminum or steel. The types of overhead sign assemblies included in this specification are span structures and cantilever structures.

Materials

Structural Steel.....	Section 1072
Overhead Sign Structures.....	Section 1096
Signing Materials.....	Section 1092
Organic Zinc Repair Paint	Article 1080-9
Reinforcing Steel	Section 1070
Direct Tension Indicators.....	Sections 440 and 1072

Construction Methods

A. General

Fabricate overhead sign assemblies in accordance with the details shown in the approved working drawings and the requirements of these specifications.

No welding, cutting or drilling will be permitted in the field, unless approved by the Engineer.

Drill bolt holes and slots to finished size. Holes may also be punched to finished size, provided the diameter of the punched holes is at least twice the thickness of the metal being punched. Flame cutting of bolt holes and slots is not permitted.

Erect sign panels in accordance with the requirements for Type A or B signs as indicated in the plans or Roadway Standard Drawings. Field drill two holes per connection in the Z bars for attaching signs to overhead structures. Provide two U-bolts at each U-bolt connection such as each truss chord to sign hanger and each truss chord to walkway support or light support. Provide two U-bolts at each U-bolt connection where ends of truss chords are supported. The minimum diameter of all U-bolts is ½-inch.

For all U-bolt connections of hanger beams to overhead assembly truss chords, provide all U-bolts with a flat washer and double nuts at each end of the U-bolts. All double nuts that are on any U-bolt shall be the same thickness and weight. When assembled, the double nuts shall be brought tight against each other by the use of two wrenches.

Use two coats of a zinc-rich paint to touch up minor scars on all galvanized materials.

For high strength bolted connections, use direct tension indicators. Galvanize bolts, nuts and washers in accordance with the 2012 *Standard Specifications for Roads and Structures*.

B. Shop Drawings

Design the overhead sign supports, including foundations, prior to fabrication. Submit design calculations and working drawings of the designs to the Engineer for review and acceptance.

Have a professional engineer registered in the State of North Carolina perform the computations and render a set of sealed, signed and dated drawings detailing the construction of each structure.

Submit to the Engineer for review and acceptance complete design and fabrication details for each overhead sign assembly, including foundations and brackets for supporting the signs, and maintenance walkways, if applicable, electrical control boxes, and lighting luminaires. Base design upon the revised structure line drawings, wind load area and the wind speed shown in the plans, and in accordance with the 2009 AASHTO *Standard Specifications for Structural Supports for Highway Signs, Luminaires and Traffic Signals, 5th Edition*, and the 2010 and 2011 Interim Revisions.

Submit thirteen (13) copies of completely detailed working drawings and one copy of the design calculations including all design assumptions for each overhead sign assembly to the Engineer for approval prior to fabrication. Working drawings shall include complete design and fabrication details (including foundations); provisions for attaching signs, maintenance walkways (when applicable), lighting luminaires to supporting structures, applicable material specifications, and any other information necessary for procuring and replacing any part of the complete overhead sign assembly.

Allow 15 days for initial working drawing review after the Engineer receives them. If revisions to working drawings are required, an additional 15 days shall be required for review and approval of the final working drawings.

Approval of working drawings by the Engineer shall not relieve the Design-Build Team of responsibility for the correctness of the drawings, or for the fit of all shop and field connections and anchors.

C. Design and Fabrication

The following criteria govern the design of overhead sign assemblies:

Design shall be in accordance with the 2009 AASHTO *Standard Specifications for Structural Supports for Highway Signs, Luminaires and Traffic Signals, 5th Edition*, and the 2010 and 2011 Interim Revisions.

Within this Specification, there are several design criteria that are owner specified. They include:

- Overhead cantilever sign structures shall include galloping loads (exclude four-chord horizontal trusses).
- The natural wind gust speed in North Carolina shall be assumed to be 11.6 mph.
- The fatigue importance category used in the design, for each type of structure, shall be for:
 - Cantilever structures with span greater than 50 feet – Fatigue Category I
 - Cantilever structures with span less than or equal to 50 feet – Fatigue Category II
 - Non-cantilever structures – Fatigue Category II

The following Specification interpretations or criteria shall be used in the design of overhead sign assemblies:

- For design of supporting upright posts or columns, the effective length factor for columns “K”, as provided for in Appendix B, Section B.5, shall be taken as the following, unless otherwise approved by the Engineer:
 - Case 1 For a single upright post of cantilever or span type overhead sign structure, the effective column length factor, “K”, shall be taken as 2.0.
 - Case 2 For twin post truss-type upright post with the post connected to one chord of a horizontal truss, the effective column length factor for that column shall be taken as 2.0.

Case 3 For twin post truss-type upright post with the post connected to two truss chords of a horizontal tri-chord or box truss, the effective column length factor for that column shall be taken as 1.65

- For twin post truss-type uprights, the unbraced length of the post shall be from the chord to post connection to the top of base plate.

For twin post truss-type uprights, when the post is subject to axial compression, bending moment, shear, and torsion the post shall satisfy the 2009 AASHTO *Standard Specifications for Structural Supports for Highway Signs, Luminaires and Traffic Signals, 5th Edition*, and the 2010 and 2011 Interim Revisions Equations 5-17, 5-18 and 5-19. To reduce the effects of secondary bending, in lieu of Equation 5-18, the following equation may be used:

$$\frac{f_a}{F_a} + \frac{f_b}{\left(1 - \frac{0.6f_a}{F_e}\right)F_b} + \left(\frac{f_v}{F_v}\right)^2 \leq 1.0$$

Where f_a = Computed axial compression stress at base of post

- The base plate thickness for all uprights and poles shall be a minimum of 2" but not less than that determined by the following criteria and design.

Case 1 Circular or rectangular solid base plates with the upright pole welded to the top surface of base plate with full penetration butt weld, and where no stiffeners are provided. A base plate with a small center hole, which is less than 1/5 of the upright diameter, and located concentrically with the upright pole, may be considered as a solid base plate.

The magnitude of bending moment in the base plate, induced by the anchoring force of each anchor bolt shall be calculated as $M = (P \times D_1) / 2$.

Case 2 Circular or rectangular base plate with the upright pole socketed into and attached to the base plate with two lines of fillet weld, and where no stiffeners are provided, or any base plate with a center hole that is larger in diameter than 1/5 of the upright diameter

The magnitude of bending moment induced by the anchoring force of each anchor bolt shall be calculated as $M = P \times D_2$.

- M - bending moment at the critical section of the base plate induced by one anchor bolt

- P - anchoring force of each anchor bolt
 - D_1 - horizontal distance between the center of the anchor bolt and the outer face of the upright, or the difference between the radius of the bolt circle and the outside radius of the upright
 - D_2 - horizontal distance between the face of the upright and the face of the anchor bolt nut
- The critical section shall be located at the face of the anchor bolt and perpendicular to the radius of the bolt circle. The overlapped part of two adjacent critical sections shall be considered ineffective.
 - The thickness of Case 1 base plate shall not be less than that calculated based on formula for Case 2.
 - Uprights, foundations, and trusses that support overhead signs shall be designed in accordance with the Overhead and Dynamic Message Sign Foundations Project Special Provision for the effects of torsion. Torsion shall be considered from dead load eccentricity of these attachments, as well as for attachments such as walkways, supporting brackets, lights, etc., that add to the torsion in the assembly. Truss vertical and horizontal truss diagonals in particular and any other assembly members shall be appropriately sized for these loads.
 - Uprights, foundations, and trusses that support overhead mounted signs shall be designed for the proposed sign wind area and future wind areas. The design shall consider the effect of torsion induced by the eccentric force location of the center of wind force above (or below) the center of the supporting truss. Truss vertical and horizontal truss diagonals in particular and any other assembly members shall be appropriately sized for these loads.

For non-cantilevered monotube sign support structures, the following table and figures are considered as a required addition to the 2009 AASHTO *Standard Specifications for Structural Supports for Highway Signs, Luminaires and Traffic Signals, 5th Edition*, and the 2010 and 2011 Interim Revisions:

Construction	Detail	Stress Category	Application	Example
Mechanically Fastened Connections	25. Bolts in Tension	D	Beam column connection for monotube structures	16
Fillet Weld Connections	26. Fillet welded with one side normal to applied stress	E'	Beam column connection for monotube structures	17
Mechanically Fastened Connections	27. High strength bolts in tension	D	Monotube or truss-chord splice	17
Fillet Weld Connections	28. Fillet welded with one side normal to applied stress	E'	Monotube or truss-chord splice	17
Mechanically Fastened Connections	29. U-bolts tied to transverse truss column to keep chords in place	D	Horizontal truss connection with vertical truss	18
Mechanically Fastened Connections	30. Net section of full-tightened, high tension bolts in shear	B	Truss bolted joint	18

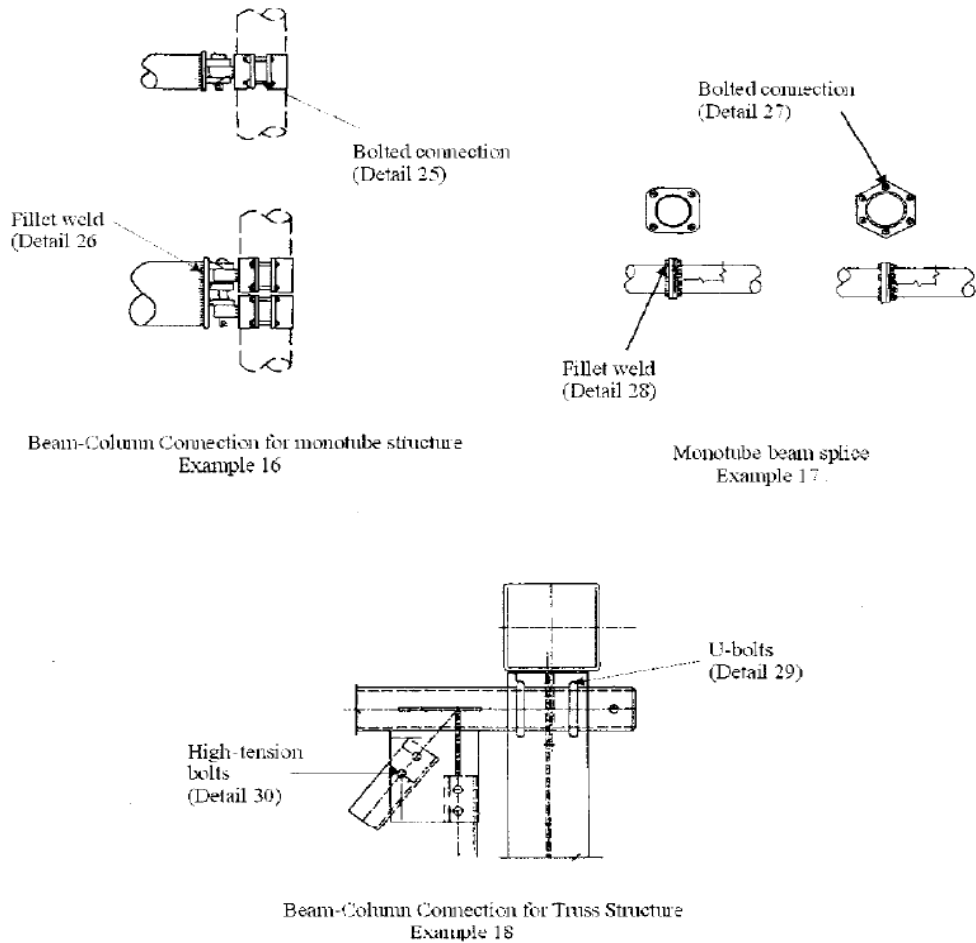
Add to the Specifications, Figure 11-1:

Fabricate all overhead sign assemblies, including but not limited to foundations, in accordance with the details shown on the approved shop drawings and with the requirements of these Specifications.

Fabricate the span and cantilever supporting structures using tubular members of either aluminum or steel, using only one type of material throughout the project.

Horizontal components of the supporting structures for overhead signs may be of a truss design or a design using singular (monotube) horizontal members to support the sign panels.

Truss or singular member centerline must coincide with the centerline of sign design area shown on the structure line drawing.

Provide permanent camber in addition to dead load camber in accordance with the 2009 AASHTO *Standard Specifications for Structural Supports for Highway Signs, Luminaires and Traffic Signals, 5th Edition*, and the 2010 and 2011 Interim Revisions. Indicate on the shop drawings the amount of camber provided and the method employed in the fabrication of the support to obtain the camber.

Use cantilever sign structures that meet the following design criteria:

- a. Do not exceed an $L / 150$ vertical dead load deflection at the end of the arm due to distortions in the arm and vertical support, where L is the length of the arm from the center of the vertical support to the outer edge of the sign.
- b. Do not exceed an $L / 40$ horizontal deflection at the end of the arm due to distortions in the arm and vertical support, as a result of design wind load.

Fabricate attachment assemblies for mounting signs in a manner that allows easy removal of sign panels for repair.

OVERHEAD AND DYNAMIC MESSAGE SIGN FOUNDATIONS

(9-1-11)

DB11 R013

Description

Sign foundations include foundations for overhead and dynamic message signs (DMS) supported by metal poles or upright trusses. Sign foundations consist of footings with pedestals or drilled piers with or without grade beams or wings, conduit and anchor rod assemblies. Construct sign foundations in accordance with the contract and accepted submittals. Define “cantilever sign” as an overhead cantilever sign support in accordance with Figure 1-1 of the AASHTO 2009 *Standard Specifications for Structural Supports for Highway Signs, Luminaires and Traffic Signals*, 5th Edition, with the 2010 and 2011 Interim Revisions.

Materials

Use sign foundation materials that meet the *Foundations and Anchor Rod Assemblies for Metal Poles* provision.

Assumed Subsurface Conditions

Assume the following soil parameters and groundwater elevation for sign foundations unless these subsurface conditions are not applicable to sign locations:

- (D) Unit weight = 120 lb/cf,
- (E) Friction angle = 30 degrees,
- (F) Cohesion = 0 lb/sf, and
- (G) Groundwater 7 feet below finished grade.

A subsurface investigation is required if the Engineer determines these assumed subsurface conditions do not apply to a sign location and the sign cannot be moved. Subsurface conditions requiring a subsurface investigation include but are not limited to weathered or hard rock, boulders, very soft or loose soil, muck or shallow groundwater. No extension of completion date or time will be allowed for subsurface investigations.

Subsurface Investigations

Use a prequalified geotechnical consultant to perform one standard penetration test (SPT) boring in accordance with ASTM D1586 at each sign location requiring a subsurface investigation. Rough grade sign locations to within 2 feet of finished grade before beginning drilling. Drill borings to 2 drilled pier diameters below anticipated pier tip elevations or refusal, whichever is higher.

Use the computer software gINT version 8.0 or later manufactured by Bentley Systems, Inc. with the current NCDOT gINT library and data template to produce SPT boring logs. Provide boring logs sealed by a geologist or engineer licensed in the state of North Carolina.

Sign Foundation Designs

Design sign foundations for the appropriate wind zone and the clearances shown in the plans developed by the Design-Build Team and the slope of finished grade at each sign location. Use the assumed soil parameters and groundwater elevation above for sign foundation designs unless a subsurface investigation is performed or required by the Engineer. For sign locations requiring a subsurface investigation, design sign foundations for the subsurface conditions at each sign location. Design footings, pedestals, drilled piers, grade beams and wings in accordance with the AASHTO 2009 *Standard Specifications for Structural Supports for Highway Signs, Luminaires and Traffic Signals*, 5th Edition, with the 2010 and 2011 Interim Revisions. In some instances, conflicts with drainage structures may dictate sign foundation types.

Design footings in accordance with Section 4.4 of the AASHTO *Standard Specifications for Highway Bridges*. Do not use an allowable bearing pressure of more than 3,000 lb/sf for footings.

Design drilled piers for side resistance only in accordance with Section 4.6 of the AASHTO *Standard Specifications for Highway Bridges* except reduce ultimate side resistance by 25% for uplift. Use the computer software LPILE version 5.0 or later manufactured by Ensoft, Inc. to analyze drilled piers. Provide drilled pier designs with a horizontal deflection of less than 1" at top of piers. For cantilever signs with single drilled pier foundations supporting metal poles, use wings to resist torsion forces. Provide drilled pier designs with a factor of safety of at least 2.0 for torsion.

For drilled pier sign foundations supporting upright trusses, use dual drilled piers connected with a grade beam having a moment of inertia approximately equal to that of either pier. The Broms' method is acceptable to analyze drilled piers with grade beams instead of LPILE. Use a safety factor of at least 3.5 for the Broms' design method in accordance with C13.6.1.1 of the AASHTO 2009 *Standard Specifications for Structural Supports for Highway Signs, Luminaires and Traffic Signals*, 5th Edition, with the 2010 and 2011 Interim Revisions.

Submit boring logs, if any, working drawings and design calculations for acceptance in accordance with Article 105-2 of the *Standard Specifications*. Submit working drawings showing plan views, required foundation dimensions and elevations and typical sections with reinforcement, conduit and anchor rod assembly details. Include all boring logs, design calculations and LPILE output for sign foundation design submittals. Have sign foundations

designed, detailed and sealed by an engineer licensed in the state of North Carolina.

Construction Methods

Construct footings, pedestals, drilled piers, grade beams and wings and install anchor rod assemblies for sign foundations in accordance with the *Foundations and Anchor Rod Assemblies for Metal Poles* provision.

AUTOMATED MACHINE GUIDANCE

(6-17-08)

General

This Special Provision contains requirements that shall be followed if the Design-Build Team elects to use Global Positioning System (GPS) machine control grading and shall be used in conjunction with Section 801 of the 2006 *Standard Specifications for Roads and Structures*. The use of this technology is referenced as Automated Machine Guidance (AMG).

All equipment using AMG shall be able to generate end results that adhere to the 2006 *Standard Specifications for Roads and Structures*. The Design-Build Team shall perform test sections for each type of work to be completed with AMG to demonstrate that the system has the capability to achieve acceptable results. If acceptable results can not be achieved, the Design-Build Team shall conform to the requirements for conventional stakeout.

The Design-Build Team shall be responsible for all errors resulting from the use of AMG and shall correct deficiencies to the satisfaction of the Engineer at no cost to the Department.

Submittals

If the Design-Build Team elects to use AMG, a Digital Terrain Model (DTM) of the design surface and all intermediate surfaces shall be developed in conjunction with plan development. The Engineer of Record shall certify that the model used for AMG is representative of the approved "Released for Construction" sealed plans. The certification and DTM files in TIN format shall be provided to the Engineer for review.

At least 90 days prior to beginning grading operations, the Design-Build Team shall submit to the Engineer an AMG Work Plan to include, but not be limited to, proposed equipment, control software manufacturer and version, types of work to be completed using AMG, project site calibration report, repetitive calibration methods for construction equipment and rover units to be used for the duration of the project, and local GPS base station to be used for broadcasting differential correction data to rover units. This may include the NC Network RTK. All surveys shall be tied to existing project control as established by the Department.

Inspection

The Engineer will perform quality assurance checks of all work associated with AMG. If it is determined that work is not being performed in a manner that will assure accurate results, the Engineer may require corrective action at no cost to the Department.

The Design-Build Team shall provide the Engineer with a GPS rover unit for use during the duration of the contract. The rover shall be loaded with the same model that is used with the AMG and shall have the same capability as rover units used by the Design-Build Team. The rover will be kept in the possession of the Engineer and will be returned to the Design-Build Team upon completion of the contract. Any maintenance or repairs required for the rover shall be the responsibility of the Design-Build Team. Formal training of at least 8 hours on the use of the proposed AMG system shall be provided to the Engineer by the Design-Build Team and the equipment manufacturer. Training shall include, but not be limited to, hardware, software, and operation of the rover unit.

Subgrade and Base Controls

If the Design-Build Team elects to use AMG for fine grading and placement of base or other roadway materials, the GPS shall be supplemented with a laser or robotic total station. Include details of the proposed system in the AMG Work Plan. In addition, the following requirements apply for the use of AMG for subgrade and base construction.

- (A) Provide control points at intervals along the project not to exceed 1000 feet. The horizontal position of these points shall be determined by static GPS sessions or by traverse connection from the original base line control points. The elevation of these control points shall be established using differential leveling from project benchmarks, forming closed loops where practical. A copy of all new control point information shall be provided to the Engineer prior to construction activities.
- (B) Provide fine grade hubs referencing the top of finish grade along the cross section at 500-foot intervals. These hubs shall be established using conventional survey methods for use by the Engineer to check the accuracy of fine grading and pavement construction and shall remain in place until completion of all pavement layers unless otherwise allowed by the Engineer.
- (C) Provide conventional survey grade stakes at other critical points such as TSs, SCs, CSs, STs, PCs, PTs, and super elevation transition points as requested by the Engineer.

LOG CROSS VANE

(8/19/13)

Description

This work consists of the construction and maintenance of physical barriers placed in and along the stream at locations designated on the On-site Mitigation Plans provided by the Department to direct the stream flow (thalweg) toward the center of the channel and to provide grade control.

The quantity of log cross vanes to be installed will be affected by the actual conditions that occur during the construction of the project.

Materials

Rootwads: Hardwood tree species with a minimum trunk diameter of 12" and shall have 15 to 20 ft. of the trunk length remaining. Reference the Project Special Provision for Rootwad.

Logs: Hardwood tree species with a minimum trunk diameter of 12". The length of each log shall be sufficient to allow proper construction in accordance with the Log Cross Vane Detail.

Item	Section
No. 57 Stone	1005 (and as may be amended in this RFP)
Filter Fabric for Drainage, Type 2	1056

Construction Methods

Log cross vanes shall be constructed according to the Log Cross Vane Detail shown on the plans or as directed. Two vanes approximately 1/3 of the stream channel's bankfull width will form a 20°– 30° angle out from the streambank toward upstream. The top elevation of both vanes will decrease from ½ bankfull elevation toward the center of the channel at a slope of 4 to 20 percent. A vane running perpendicular to the stream's flow and at the streambed elevation will connect the two outside vanes on the upstream end. The perpendicular vane log and the vane arm logs shall be anchored together by pinning with rebar or cabling and anchored to the streambed as directed. The vane shall be anchored to the streambed with cabled earth anchors. Earth anchors shall have a minimum bearing capacity of 500 pounds. Install the upstream end of the vane arms, secure to the perpendicular vane log, and bury them under the streambed according to the detail. Plate the upstream side of the vane with Type 2 filter fabric and No. 57 stone. The filter fabric shall be securely fastened to the back of the log using galvanized roofing nails on approximately 8" centers. The downstream end of the log at the ½ bankfull elevation shall be anchored to the rootwad by pinning with rebar or cabling as directed. The log cross vane shall be keyed into the bank at the downstream end using the rootwads as shown on the Log Cross Vane Detail. Cable used to secure and anchor vane logs and rootwads shall be a minimum of 7x7, 1/8" diameter, stainless steel wire rope. The Design-Build Team shall furnish and install all rootwads per the plans or as directed. Hardwood trees encountered during clearing and grubbing may be identified and stockpiled for use as rootwads or logs. The Design-Build Team, upon removal of the trunk and root, shall remove soil to the extent acceptable by the Engineer. Care shall be taken to preserve the root structure on the harvested trees to be used as rootwads as shown on the detail in the plans.

ROCK CROSS VANE

(8/19/13)

Description

This work consists of the construction and maintenance of physical barriers placed in and along the stream at locations designated on the On-site Mitigation Plans provided by the Department to direct the stream flow (thalweg) toward the center of the channel and to provide grade control.

The quantity of rock cross vanes to be installed will be affected by the actual conditions that occur during the construction of the project.

Materials

Item	Section
Boulder	1042 and Project Special Provision for Structure Stone
No. 57 Stone	1005 (and as may be amended in this RFP)
Rip Rap, Class A	1042
Filter Fabric for Drainage, Type 2	1056

Boulders shall be used as header and footer rocks for this device.

Construction Methods

Rock cross vanes shall be constructed in accordance with the Rock Cross Vane Detail shown in the plans or as directed. Two vanes, each approximately 1/3 of the stream channel’s bankfull width, will form a 20°– 30° angle out from the streambank toward upstream. The top elevation of both vanes will decrease from bankfull elevation toward the center of the channel at a slope of 4 to 10 percent. A vane running perpendicular to the stream’s flow will connect the two outside vanes on the upstream end. Install header and footer rocks according to the detail and plate the upstream side with Type 2 filter fabric and No. 57 stone. Voids between the header and footer rocks can be filled with hand-placed Class A Rip Rap as directed. Footer rocks shall be placed such that the header rock is at streambed elevation. The rock cross vane shall be keyed into the bank at the downstream end as shown on the Rock Cross Vane Detail.

CONSTRUCTED RIFFLE

(8/19/13)

Description

This work consists of the construction and maintenance of physical barriers placed in and along the stream at locations designated on the On-site Mitigation Plans provided by the Department to provide grade control.

The quantity of constructed riffles to be installed will be affected by the actual conditions that occur during the construction of the project.

Materials

Item	Section
No. 57 Stone	1005 (and as may be amended in this RFP)
Rip Rap, Class A	1042
Rip Rap, Class B	1042

Construction Methods

Constructed riffles shall be constructed according to the Constructed Riffle Detail shown on the plans or as directed.

ROOTWAD

(8/19/13)

Description

This work consists of collecting or furnishing, storage, preparation and installation of all materials required for proper installation of *Rootwads*.

The quantity of rootwads to be installed will be affected by the actual conditions that occur during the construction of the project.

Materials

Rootwads: Hardwood tree species with a minimum trunk diameter of 12" and should have 15 to 20 feet of the trunk length remaining.

Refer to Division 10

Item	Section
Boulder	1042 and Project Special Provisions for Structure Stone

Construction Methods

The Contractor shall furnish and install all rootwads as shown on the On-site Mitigation Plans provided by the Department or as directed. Hardwood trees encountered during clearing and grubbing may be identified and stockpiled for use as rootwads. The Contractor, upon removal of the trunk and root, shall remove soil to the extent acceptable by the Engineer. Care shall be taken to preserve the root structure on the harvested trees to be used as rootwads as shown on the Rootwad Detail in the plans.

Rootwad sections shall be constructed by the drive point or trenching method, according to the Rootwad Detail shown on the plans or as directed. Place the rootwad on top of the boulders. For rootwads installed using the trenching method, pin the rootwad down using boulders and place fill material over the structure.

ROCK A- VANE

(8/19/13)

Description

This work consists of the construction and maintenance of physical barriers placed in and along the stream at locations designated on the plans to direct the stream flow (thalweg) toward the center of the channel and to provide grade control.

The quantity of rock cross vanes to be installed will be affected by the actual conditions that occur during the construction of the project.

Materials

Refer to Division 10

Item	Section
Boulder	1042 and Project Special Provision for Structure Stone
No. 57 Stone	1005 (and as may be amended in this RFP)
Rip Rap, Class A	1042-1
Filter Fabric for Drainage, Type 2	1056

Boulders shall be used as header and footer rocks for this device.

Construction Methods

Rock cross vanes shall be constructed in accordance with the Rock A-Vane Detail shown in the plans or as directed. Two vanes, each approximately 1/3 of the stream channel's bankfull width, will form a 20°– 30° angle out from the streambank toward upstream. The top elevation of both vanes will decrease from bankfull elevation toward the center of the channel at a slope of 4 to 20 percent. A vane running perpendicular to the stream's flow will connect the two outside vanes on the upstream end. Install header and footer rocks according to the detail and plate the upstream side with Type 2 filter fabric and No. 57 stone. Voids between the header and footer rocks can be filled with hand-placed Class A rip rap as directed. Footer rocks shall be placed such that the header rock is at streambed elevation. The rock a-vane shall be keyed into the bank at the downstream end as shown on the Rock A-Vane Detail.

LOG VANE

(8/19/13)

Description

The work covered by this section consists of the construction and maintenance of physical barriers placed in and along the stream at locations designated on the On-site Mitigation Plans provided by the Department to direct the stream flow (thalweg) toward the center of the channel.

The quantity of log vanes to be installed will be affected by the actual conditions that occur during the construction of the project.

Materials

Logs: Hardwood tree species with a minimum trunk diameter of 12". The length of each log shall be sufficient to allow proper construction in accordance with the Log Vane Detail.

Refer to Division 10

Item	Section
Boulder	1042 and Project Special Provision for Structure Stone
No. 57 Stone	1005 (and as may be amended in this RFP)
Rip Rap, Class A	1042-1
Filter Fabric for Drainage, Type 2	1056

Boulders shall be used as header and footer rocks for this device.

Construction Methods

Log vanes shall be constructed according to the log vane detail shown on the plans or as directed. A vane each approximately 1/3 of the stream channel's bankfull width will form a 20°– 30° angle out from the streambank toward upstream. The top elevation of the vane will decrease from bankfull elevation toward the center of the channel at a slope of 4 to 10 percent. Install header and footer rocks and bury the upstream end of the log under the streambed according to the detail and plate the upstream side of the vane with Type 2 filter fabric and No. 57 stone. The filter fabric shall be securely fastened to the back of the log using galvanized roofing nails on approximately 8" centers. Voids between the header and footer rocks can be filled with hand-placed Class A Rip Rap as directed. Footer rocks shall be placed such that the header rock is at streambed elevation. The downstream end of the log at the bankfull elevation shall be anchored by pinning with header and footer rocks. The log vane shall be keyed into the bank at the downstream end as shown on the log vane detail. Native hardwood trees encountered during clearing and grubbing may be identified and stockpiled for use as logs for the log vanes.

STREAM PLUG

(8/19/13)

Description

This work consists of the construction, maintenance, and removal of physical barriers placed in ditches, diversions or swales to reduce water flow.

The quantity of stream plugs to be constructed will be affected by the actual conditions that occur during the construction of the project.

Materials

Stream plugs shall consist of *Impervious Select Material* that shall meet the specifications as provided elsewhere in this contract.

Construction Methods

Stream plugs shall be constructed at locations as shown on the On-site Mitigation Plans provided by the Department or as directed by the Engineer. Clear and grub all side slopes of the channel. Place stream plug in channel ensuring that there is at least 5 ft. of embankment material between the plug and the face of the restored stream bank. Construct the stream plug across the entire width of the channel and to an elevation of 2 ft. below the proposed fill elevation as shown on the plans. The length of the stream plug is to be a minimum of 15 ft.

The removal and disposal of silt accumulations shall be performed in accordance with Section 1630-1 and 1630-2 of the *2012 Standard Specifications for Roads and Structures*.

LOG SILL

(8/19/13)

Description

This work consists of the construction and maintenance of physical barriers placed in and along the stream at locations designated on the On-site Mitigation Plans provided by the Department to direct the stream flow (thalweg) toward the center of the channel and to provide grade control.

The quantity of log sill to be installed will be affected by the actual conditions that occur during the construction of the project.

Materials

Logs: Hardwood tree species with a minimum trunk diameter of 12". The length of each log shall be sufficient to allow proper construction in accordance with the Log Sill Detail.

Refer to Division 10

Item	Section
Boulder	1042 and Project Special Provision for Structure Stone
No. 57 Stone Rip Rap, Class A	1005 (and as may be amended in this RFP) Table 1042-1
Filter Fabric for Drainage, Type 2	1056

Construction Methods

Log Sill shall be constructed according to the Log Sill Detail shown on the plans or as directed. Logs shall be anchored together by pinning with 1/2" rebar and anchored to the streambed as directed. Place header and footer boulders as shown on the detail. Plate the upstream side of

the logs with Type 2 filter fabric and No. 57 stone. The filter fabric shall be securely fastened to the back of the log using galvanized roofing nails on approximately 8" centers. The log shall be keyed into the bank at the downstream end. The Contractor shall furnish and install all logs per the plans or as directed. Hardwood trees encountered during clearing and grubbing may be identified and stockpiled for use as logs. Care shall be taken to preserve the log structure on the harvested trees to be used as log sills as shown on the detail in the plans.

NATURAL ROCK ENERGY DISSIPATER

(8/19/13)

SPI

Description

This work consists of the construction and maintenance of natural rock energy dissipaters.

Materials

Refer to Divisions 2 & 10 of the 2012 *Standard Specifications for Roads and Structures*.

Item	Section
Rip Rap Class II (natural rock)	1042
Filter Fabric for Drainage, Type 2	1056
Drainage Ditch Excavation	240

Construction Methods

Natural rock energy dissipaters shall be constructed in accordance with the detail shown in the plans or as directed by the Engineer. From the outlet invert of a culvert (or bottom of a ditch) excavation will drop to a specified depth. Excavation will continue to widen through the dissipater. Natural Rock will be placed along the banks and bottom of the dissipater and along the apron.

BOULDER TOE PROTECTION

(8/19/13)

Description

The work covered by this section consists of the construction of physical barriers placed along the banks of the stream at locations designated on the plans.

The quantity of Boulder Toe Protection to be installed will be affected by the actual conditions that occur during the construction of the project.

Materials

Item	Section
Filter Fabric for Drainage, Type 2	1056
Boulder	1042 and Project Special Provision for Structure Stone
No. 57 Stone	1005 (and as may be amended in this RFP)
Rip Rap, Class A	1042

Construction Methods

Boulder Toe Protection shall be constructed according to the Boulder Toe Protection shown on the plans or as directed by the Engineer. The footer boulders shall be set where the top of the rock shall be at the channel invert elevation. Rip Rap Class A and No. 57 stone shall be used to fill the voids and backfill behind the structure. Filter Fabric for Drainage shall be used behind the structure as shown in the detail.

STRUCTURE STONE

(8/19/130)

Description

This work consists of furnishing, stockpiling, placing and maintaining approved stone used to construct rock cross-vanes, rock vanes, j-hook vanes, w-rock cross vanes, log vanes, root wad/log vanes, log cross vanes, root wad structures, rock cross vanes for step pools, channel blocks, double wing deflectors, single wing deflectors, stream crossings, rock energy dissipaters, constructed riffles, and for use in other locations as directed.

The quantity of stone to be installed will be affected by the actual conditions that occur during the construction of the project.

Materials

Refer to Division 10

Item	Section
No. 57 Stone	1005 & Standard Special Provisions, Materials found elsewhere in RFP
Rip Rap, Class A, B, 1, and 2	1042
Filter Fabric for Drainage, Type 2	1056

Boulders shall meet the requirements of Section 1042 of the 2012 *Standard Specifications for Roads and Structures*. Boulders of minimum dimension 48" x 36" x 24" shall be individually picked for use in the structures. Boulders shall be relatively flat on either side in the same dimension, preferably the long dimension.

Construction Methods

The Contractor shall place filter fabric and stone in locations and to the thickness, widths, and lengths as shown on the plans or as directed. All stone shall be placed to form a sediment and erosion control device, an in-stream structure, or a channel lining neatly and uniformly with an even surface in accordance with the contract and shall meet the approval of the Engineer.

SITE GRADING

(8/19/13)

Description

The Design-Build Team shall perform grading as necessary to attain final surface elevations as shown on the plans and in the details.

Construction Methods**(A) Site Grading**

The Design-Build Team shall perform grading as necessary to attain final surface elevations as shown on the plans and in the details. Field modifications shall be approved by the Engineer. Final grades shall meet the plan and stream dimensions within a tolerance of +/- 0.2 feet (2.4 inches).

(B) Stream Excavation/Ditch Filling

In areas where ditches are to be filled, the Contractor shall comply with the requirements of Subarticle 235-4(C) of the 2012 *Standard Specifications for Roads and Structures* to obtain a minimum 95% compaction rate. Lift thickness shall not exceed 1 ft. and compaction shall be achieved by use of mechanical compaction equipment only. Fill material shall be such that the Plasticity Index (PI) shall be equal to or greater than that of the PI in each surrounding soil strata. Organic material shall not exceed 10% of the total volume of the fill material used. No compaction shall be performed for graded areas unless directed.

Excess material shall be disposed of as shown on the plans or as directed.

CONSTRUCTION SURVEYING FOR MITIGATION

(8/19/13)

Description

Construction Surveying for Mitigation shall be performed in accordance with Section 801 of the 2012 *Standard Specifications for Roads and Structures* and shall include but not be limited to the layout of the stream channel, temporary and permanent easements, and all sensitive areas associated with the implementation of the design as indicated in the plans. The Design-Build Team shall maintain a level and rod onsite at all times for use by the Engineer to ensure adequate

stream grades are achieved. This will not alleviate the contractor’s responsibility to make certain that the stream is constructed in accordance with the project plans and provisions.

Construction Methods

Stakeout of the stream channel in its entirety shall be performed in such a way that the Engineer can verify the layout of the stream channel prior to construction activities commencing. The Design-Build Team shall mark the proposed location of the top of banks and centerline of the channel. At a minimum, ditch stakes shall be placed to indicate the head of riffle and max pool locations within the proposed channel. Differing front and back slopes shall be indicated on the stake. Stakes shall be maintained until final inspection of the project. There will be no additional payment for re-staking.

Upon completion of the stakeout and prior to beginning construction, the Design-Build Team shall give the Engineer a 48-hour notice in order to approve the stream alignment.

ROCK VANE

(8/19/13)

Description

This work consists of the construction and maintenance of physical barriers placed in and along the stream at locations designated on the On-site Mitigation Plans provided by the Department to direct the stream flow (thalweg) toward the center of the channel.

The quantity of rock vanes to be installed will be affected by the actual conditions that occur during the construction of the project.

Materials

Refer to Division 10

Item	Section
Boulder	1042 and Project Special Provisions for Structure Stone
No. 57 Stone	1005 (and as may be amended in this RFP)
Rip Rap, Class A	1042-1
Filter Fabric for Drainage, Type 2	1056

Boulders shall be used as header and footer rocks for this device.

Construction Methods

Rock vanes shall be constructed in accordance with the Rock Vane Detail shown in the plans or as directed. A vane, each approximately 1/3 of the stream channel’s bankfull width, will form a 20°– 30° angle out from the streambank toward upstream. The top elevation of the vane will decrease from bankfull elevation toward the center of the channel at a slope of 4 to 20 percent.

Install header and footer rocks according to the detail and plate the upstream side with Type 2 filter fabric and No. 57 stone. Voids between the header and footer rocks can be filled with hand-placed Class A Rip Rap as directed. Footer rocks shall be placed such that the header rock is at streambed elevation. The rock vane shall be keyed into the bank at the downstream end as shown on the Rock Vane Detail.

PUMP AROUND OPERATION

(8/19/13)

Description

The work covered by this section consists of furnishing, installing, maintaining and removing any and all pump around systems used on this project. The Design-Build Team shall install a pump around system in locations chosen by the Design-Build Team and approved by the Engineer. The pump around system shall provide a passageway for the stream flow around the work site.

The quantity of pump around systems may be increased, decreased, or eliminated entirely as directed. Such variations in quantity will not be considered as alterations in the details of construction or a change in the character of the work. See example pump around operation detail on the On-site Mitigation Plans provided by the Department.

Construction Methods

Install a temporary impervious dike as shown on the detail. Pump water around the work site. If the water is turbid or exposed to bare soil, pump through a special stilling basin. Follow detail for the pump around operation. Once the work is complete in an area remove the impervious dike and pump system. Place structures in the area and stabilize immediately following removal of pump around system.

IMPERVIOUS SELECT MATERIAL

(8/19/13)

Description

This work consists of furnishing, stockpiling, placing and maintaining impervious select material for stream plugs in locations as shown on the On-site Mitigation Plans provided by the Department and cross-sections or as directed.

The quantity of impervious select material to be installed will be affected by the actual conditions that occur during the construction of the project.

Materials

Materials that will function as impervious barriers to water movement shall be a silty or clay soil material meeting the requirements of AASHTP M 145 for soil classification A-2, A-6 and A-7 provided such materials do not have a Liquid Limit (LL) greater than 50. To maintain soil

workability for placement and compaction, the following criteria shall apply for Plasticity Index (PI):

Position of Borrow Material

Below the water table
Above the water table

Constraints on Plasticity Index (PI)

Must be greater than 7 and less than 25
Must be greater than 7 and less than 35

Plasticity Index shall be determined in accordance with AASHTO T90 and the Liquid Limit shall be determined in accordance with AASHTO T89. The Contractor is cautioned that soils tend to become less workable as the PI increases above 20. Although a PI of 35 may be acceptable, the Contractor shall be aware that additional efforts might be necessary to work the soil in order to achieve the minimum compaction standards.

Construction Methods

Impervious select material for stream plugs shall be constructed at locations as shown on the plans and cross-sections or as directed. Impervious select material for stream plugs shall be used at the outlet end of uncompacted channel fills, and may be used at other locations to provide surface drainage relief from the uncompacted fills.

(A) Clearing and Grubbing

Clear and Grub the stream plug cross-section on all sides to remove all vegetation and root mat material as directed to an elevation at least 1 ft. below the elevation of the existing channel cross-section.

(B) Construction

Construct the stream plug using material that meets the requirements of the Materials section listed above. Construct the stream plug to the dimensions detailed on the plans.

CONTRACTOR REQUIREMENTS FOR STREAM RELOCATIONS, RESTORATIONS, AND ENHANCEMENTS

(8/19/13)

If the Design-Build Team has not completed two (minimum 1000 linear feet each) or one (minimum of 2500 linear feet) stream relocation, restoration, or enhancement projects, that included channel reconstruction or relocation based upon natural geomorphic designs incorporating in-stream structures (i.e., rock cross vanes, rock vanes, j-hook vanes and rootwads), they will be required to sublet such work to a contractor who has the experience in this type of work. Documentation of past experience must be submitted to the Engineer before any work begins on the stream relocation, restoration or enhancement.

If the Engineer deems that the qualified contractor is performing unsatisfactory work, the Engineer reserves the right to request another qualified contractor to complete the work.

GEOTEXTILE FOR PAVEMENT STABILIZATION

(1-21-14)

Description

Furnish and place geotextile for pavement stabilization in accordance with the **Geotechnical Engineering Scope of Work** found elsewhere in this RFP. Geotextile for pavement stabilization may be required to prevent pavement cracking and provide separation between the subgrade and pavement section at locations shown in the plans developed by the Design-Build Team and as directed by the Engineer.

Materials

Refer to Division 10 of the **2012 Standard Specifications for Roads and Structures**.

Item	Section
Geotextiles	1056

Provide Type 5 geotextile for geotextile for pavement stabilization that meets the following requirements:

GEOTEXTILE FOR PAVEMENT STABILIZATION REQUIREMENTS		
Property	Requirement (MARV ^A)	Test Method
Tensile Strength @ 5% Strain (MD & CD ^A)	1,900 lb/ft	ASTM D4595
Ultimate Tensile Strength (MD & CD ^A)	4,800 lb/ft	ASTM D4595
Melting Point	300° F	ASTM D276

A. Define “minimum average roll value” (MARV), “machine direction” (MD) and “cross-machine direction” (CD) in accordance with ASTM D4439.

Sampling

The Design-Build Team shall take soil samples, after the project has been graded to within 2 inches of final sub-grade elevation. The Design-Build Team shall sample the top 3 feet in one foot depth increments at a minimum frequency of one sample set (3 samples at one foot increments) per 1,000 feet, per each lane, for classification tests. For the aforementioned tests, a lane shall be considered 28 feet wide in one direction for sampling purposes. Additional samples shall be taken to ensure that all the predominant soil types, limits of distribution of these soils and different site conditions have been represented. For embankments less than 1,000 feet in length a minimum of one sample set **shall be required**. The top increment of the sample set may also serve as the sample for the lime or cement mix design test.

Submittals for Review and Approval Prior to Construction

The Design-Build Team shall adhere to the following submittal guidelines:

- Submit all laboratory test results for review to the Geotechnical Engineering Unit – Geopavement Section within 5 days of completion.
- Submit a sketch in plan view showing areas of the project to be stabilized by geotextile for pavement stabilization.

- Submit any other documentation that supports the Design-Build Team's recommendations.

Construction Methods

The Design-Build Team shall determine if geotextile for pavement stabilization is required. The Design-Build Team shall show proposed locations in the plan views developed by the Design-Build Team and at other locations as directed by the Engineer. Allow 10 days after lab tests are received to determine if geotextile for pavement stabilization is required in additional locations. In areas with geotextile for pavement stabilization, the limits of the geotextile shall match limits of the stabilized subgrade.

Place geotextile for pavement stabilization on top of the finished subgrade as shown in the plans developed by the Design-Build Team and in slight tension free of kinks, folds, wrinkles or creases. Install geotextiles with the MD perpendicular to the roadway centerline. The MD is the direction of the length or long dimension of the geotextile roll. Do not splice or overlap geotextiles in the MD so splices or overlaps are parallel to the roadway centerline. Extend geotextile for pavement stabilization 12" beyond the base course as shown in the plans developed by the Design-Build Team.

Completely cover subgrades with geotextile for pavement stabilization so geotextiles are adjacent to each other in the CD, i.e., perpendicular to the MD. The CD is the direction of the width or short dimension of the geotextile roll. Overlapping geotextiles in the CD is permitted but not required. Overlap geotextiles in the direction that base course will be placed to prevent lifting the edge of the top geotextile.

For asphalt base courses, asphalt mixture temperatures in the truck may not exceed 315° F at the time of placement. Do not damage geotextile for pavement stabilization when constructing base courses. Place and compact base courses in accordance with the 2012 *Standard Specifications for Roads and Structures*. Do not operate heavy equipment on geotextiles any more than necessary to construct pavement sections. Replace any damaged geotextiles to the satisfaction of the Engineer.

GENERAL

The State will not be bound by oral explanations or instructions given at any time during the bidding process or after award. Only information that is received in response to this RFP will be evaluated; reference to information previously submitted will not suffice as a response to this solicitation.

NO CONTACT CLAUSE

To ensure that information is distributed equitably to all short-listed Design-Build Teams, all questions and requests for information shall be directed to the State Contract Officer through the Design-Build e-mail address. This precludes any Design-Build team member, or representative, from contacting representatives of the Department, other State Agencies or Federal Agencies, or the Piedmont Triad Airport Authority either by phone, e-mail or in person concerning the Design-Build Project.

USE OF TERMS

Throughout this RFP and all manuals, documents and standards referred to in the RFP the terms Contractor, Bidder, Design-Builder, Design-Build Team, Team, Firm, Company and Proposer are synonymous.

Throughout this RFP and all manuals, documents and standards referred to in the RFP, the terms NCDOT, Department, Engineer and State are synonymous.

Throughout this RFP and all documents referred to in the RFP, references to the Technical Proposal include all Technical Proposal supplemental information that may be submitted in response to a Best and Final Offer RFP.

DESIGN REFERENCES

Design references developed and published by NCDOT and those developed and published by other agencies and adopted for use by NCDOT which are to be used in the design of this project may be obtained by contacting Contract Standards and Development within the Technical Services Division. Standard prices for materials, which the Department normally sells for a fee, will be in effect. The Design-Build Team shall be responsible for designing in accordance with the applicable documents and current revisions and supplements thereto.

REVIEW OF SUBMITTALS

Major design milestones and required design submittals shall be identified as activities on a CPM, bar chart or other scheduling tool. This schedule shall be submitted to the Transportation Program Management Director and Resident Engineer concurrently with the first design submittal, or within 30 days of the contract award, whichever is earlier. The schedule shall be revised and resubmitted as design milestones change or as directed by the Transportation Program Management Director. Submittals will be reviewed within 10 working days (15 days for temporary structures, overhead sign assemblies, MSE walls, FEMA compliance documents, curved steel girder working drawings and temporary shoring) from the date of receipt by

NCDOT unless otherwise stipulated in the scope of work. All submittals shall be prepared and submitted in accordance with the “*Design-Build Submittal Guidelines*”, which by reference are incorporated and made a part of this contract. All submittals shall be made simultaneously to the Transportation Program Management Director and the Resident Engineer. The Department will not accept subsequent submittals until prior submittal reviews have been completed for that item. The Design-Build Team shall inform the Transportation Program Management Director in writing of any proposed changes to the NCDOT preliminary designs, Technical Proposal and / or previously reviewed submittals and obtain approval prior to incorporation. The Design-Build Team shall prioritize submittals in the event that multiple submittals are made based on the current schedule. All submittals shall include pertinent Special Provisions. No work shall be performed prior to Department review and acceptance of the design submittals.

OVERVIEW

The Design-Build Project I-5110, R-2413A & R-2413B consists of constructing a four-lane divided freeway primarily on new location. The project will extend the future I-73 from the Joseph M. Bryan Boulevard (SR 2085) and Airport Parkway interchange, west to NC 68 and then northeast toward US 220 where it will connect with the US 220 interchange currently under construction (TIP Project No. R-2413C / R-2309). The proposed project is approximately 9.4 miles.

Project services shall include but are not limited to:

- **Design Services** – completion of construction plans
- **Construction Services** – necessary to build and ensure workmanship of the designed facility
- **Permit Preparation / Application** – development of all documents for required permits
- **Right of Way** – acquisition of all additional right of way necessary to construct project, as needed, including Permanent Utility Easements

The I-5110 Environmental Assessment (EA) was completed in February 2012 and the Finding of No Significant Impact (FONSI) was completed in September 2012.

The R-2413 State Environmental Assessment (EA) was completed in August 1993 and the State Finding of No Significant Impact (FONSI) was completed in March 1995. A Re-evaluation for this project was completed in August 2009.

The Categorical Exclusion (CE) for the proposed taxiway bridge was completed and received Federal Aviation Administration approval in February 2013.

Construction Engineering Inspection will be provided by the NCDOT Division personnel or will be performed under a separate contract.

GENERAL SCOPE

The scope of work for this project includes design, construction and management of the project. The design work includes all aspects to construct approximately 9.4 miles of a four-lane divided facility. The designs shall meet all appropriate latest versions of AASHTO *Policy on Geometric Design of Highways and Streets*, AASHTO *LRFD Bridge Design Specifications*, *Manual of Uniform Traffic Control Devices* and all NCDOT design policies that are current as of the Technical and Price Proposal submission date or the Best and Final Offer submission date.

Construction shall include, but not be limited to, all necessary work items for clearing, grading, roadway, drainage, structures, utility coordination, erosion and sediment control, foundation, substructure and superstructure work. Construction shall comply with NCDOT *Standard Specifications for Roads and Structures* and all applicable special provisions. Areas of work required for this project will include, but are not limited to the following items:

- Roadway Design
- Structure Design
- Hydraulic Design
- Permit Application
- Foundation Design for Structures and Roadway
- Erosion and Sedimentation Control Design and Implementation
- R/W Utilities, Conflicts and / or Construction
- Transportation Management Plan Design and Implementation
- Pavement Marking Design
- Sign Design
- Traffic Signal Design
- Intelligent Traffic Systems (ITS) Design
- Construction
- Project Management
- Design and Construction Management
- Construction Surveying
- Location and Surveys
- Right of Way Acquisition
- Public Information
- On-Site Mitigation

All designs shall be in Microstation format using Geopak software (current version used by the Department).

DESIGN AND CONSTRUCTION PERFORMED BY DESIGN-BUILD TEAM

As outlined in the Scope of Work section of this RFP, the design work consists of the preparation of all construction documents to construct a four-lane divided facility, future I-73, from Joseph M. Bryan Boulevard / Airport Parkway Interchange to south of US 220, a distance of approximately 9.4 miles. The Design-Build Team shall prepare final designs, construction drawings and special provisions.

Unless noted otherwise elsewhere in this RFP, the Design-Build Team shall acknowledge that project documents furnished by the Department are preliminary and provided solely to assist the Design-Build Team in the development of the project design. The Design-Build Team shall be fully and totally responsible for the accuracy and completeness of all work performed under this contract and shall save the State harmless and shall be fully liable for any additional costs and all claims against the State which may arise due to errors, omissions and negligence of the Design-Build Team in performing the work required by this contract.

There shall be no assignment, subletting or transfer of the interest of the Design-Build Team in any of the work covered by the Contract without the written consent of the State, except that the Design-Build Team may, with prior written notification of such action to the State, sublet property searches and related services without further approval of the State.

The Design-Build Team shall certify all plans, specifications, estimates and engineering data furnished by the Team.

All work by the Design-Build Team shall be performed in a manner satisfactory to the State and in accordance with the established customs, practices, and procedures of the North Carolina Department of Transportation, and in conformity with the standards adopted by the American Association of State Highway Transportation Officials, and approved by the U.S. Secretary of Transportation as provided in Title 23, U.S. Code, Section 109 (b). The decision of the Engineer / State / Department shall control in all questions regarding location, type of design, dimension of design, and similar questions.

Alternate designs, details or construction practices (such as those employed by other states, but not standard practice in NC) are subject to Department review and approval, and will be evaluated on a case by case basis.

The Design-Build Team shall not change team members, subconsultants or subcontractors identified in the Statement of Qualifications (SOQ) or Technical Proposal without written consent of the Engineer or the State Contract Officer. In addition, subconsultants and subcontractors not identified in the SOQ or Technical Proposal shall not perform any work without written consent by the Engineer. Individual offices of the Design-Build Team not identified in the Statement of Qualifications or the Technical Proposal submitted shall not perform any work without written consent by the Engineer. Failure to comply with this requirement may be justification for removing the Team from further consideration for this project and disqualification from submitting on future Design-Build Projects.

All firms shall be prequalified by the Department for the work they are to perform. Joint Ventures, LLCs or any legal structure that are different than the existing prequalification status must be prequalified prior to the Technical and Price Proposal submittal deadline. Subcontractors need only be prequalified prior to performing the work. Design firms should be prequalified prior to the Technical and Price Proposal submittal deadline. If not prequalified at the time of the Technical and Price Proposal submittal deadline, the prime contractor shall be solely responsible for either (1) ensuring that the design firm is prequalified prior to its first design submittal or (2) replacing that firm with a prequalified firm. Design firms and Natural Systems firms are prequalified by the particular office performing the work. If the work is to be performed by an

office other than the one that is prequalified, that office shall be prequalified prior to any design submittals.

ACCESS TO PROVIDED MATERIALS

To facilitate distribution of documents that may be helpful to the Design-Build Teams in their development of a Technical and Price Proposal and subsequent designs, project material will be made accessible through a secure web portal. The Design-Build Project Manager for each short-listed team shall provide a list of team members that will require access to this portal. This list shall include the name, e-mail address and North Carolina Identity Management (NCID) for each individual team member. Once the list is complete, it shall be submitted to the Design-Build e-mail address (designbuild@ncdot.gov). No distribution of Provided Materials will be possible prior to this list being submitted and the access privileges established as noted herein.

To create an NCID account, each individual shall go to NCDOT's Connect website (<https://connect.ncdot.gov>) and click on the "How to get an Account" link and then, "Create NCID".

The Department will obtain access rights for these individuals and notify the Design-Build Project Manager accordingly. Individuals may then re-enter the "Connect" site and login with their NCID account. Once logged in, the Teamsite "I-5110 / R-2413A & B Project" link will be apparent on the left side of the webpage.

Please note that all material provided, including the material provided through this portal, is provided for informational purposes only and is provided solely to assist the Design-Build Team in the development of the project design, unless noted otherwise elsewhere in this RFP. By submitting a Technical Proposal and Price Proposal, the Design-Build Team acknowledges that they are fully and totally responsible for the project design, including the use of portions of the Department design, modification of such design, or other designs as may be submitted by the Design-Build Team, unless noted otherwise elsewhere in this RFP. The Design-Build Team further acknowledges that they are fully and totally responsible for the accuracy and completeness of all work performed, including the determination of the accuracy of the information provided through this portal, and to the extent that the Design-Build Team chooses to rely on such information.

ETHICS POLICY

Employees employed by the Design-Build Team or employees employed by any subconsultant for the Design-Build Team to provide services for this project shall comply with the Department's Ethics Policy. Failure to comply with the Ethics Policy will result in the employee's removal from the project and may result in removal of the Company from the Department's appropriate prequalified list.

APPROVAL OF PERSONNEL

The Department will have the right to approve or reject any personnel, assigned to a project by the Design-Build Team.

In the event of engagement of a former employee of the Department, the Design-Build Team or their subcontractors shall restrict such person or persons from working on any of the Design-Build Team's contracted projects in which the person or persons were "formerly involved" while employed by the State. The restriction period shall be for the duration of the contracted project with which the person was involved. *Former Involvement* shall be defined as active participation in any of the following activities:

- Drafting the contract
- Defining the contract scope
- Design-Build Team selection
- Negotiation of the contract cost (including calculating manhours or fees); and
- Contract administration

An exception to these terms may be granted when recommended by the Secretary and approved by the Board of Transportation.

Failure to comply with the terms stated above in this section shall be grounds for termination of this contract and / or not being considered for selection of work on future contracts for a period of one year.

SUBMITTAL OF TECHNICAL AND PRICE PROPOSALS

Technical and / or Price Proposals that do not adhere to all the requirements noted below may be considered non-responsive and may result in the Department not considering the Design-Build Team for award of the contract or reading their Price Proposal publicly.

GENERAL

Technical and Price Proposals will be accepted until **4:00 p.m. Local Time on Monday, March 10, 2014**, at the office of the State Contract Officer:

Mr. Randy A. Garris, PE
Contract Standards and Development
1020 Birch Ridge Drive
Century Center Complex - Building B
Raleigh, NC 27610

No Proposals will be accepted after the time specified.

Proposals shall be submitted in two separate, sealed parcels containing the Technical Proposal in one and the Price Proposal in the other parcel.

TECHNICAL PROPOSAL

Technical Proposals shall be submitted in a sealed package. The outer wrapping shall clearly indicate the following information:

Technical Proposal
Submitted By: (Design-Build Team's Name)
Design-Build Team Address
Contract Number C 203433
TIP Number I-5110, R-2413A & R-2413B
Guilford County

Future I-73 from Joseph M. Bryan Boulevard / Airport Parkway Interchange to south of US 220

If delivered by mail, the sealed envelope shall be placed in another sealed envelope and the outer envelope addressed to the Contract Officer as stated in the Request for Proposals. The outer envelope shall also bear the statement "Technical Proposal for the Design-Build of State Highway Contract No. C 203433".

Technical Proposal Requirements

12 Copies
8 ½ inch by 11 inch pages
No fold-out sheets allowed
Printed on one side only
Double-spaced
Font size 12

Minimal font size 10 is permissible within embedded tables, charts, or graphics. No more than 50 pages, excluding the introductory letter to Mr. Randy Garris, P.E. (two-page maximum length) and the 11 inch by 17 inch appropriate plan sheets.

24 x 36 inch fold out sheets will only be allowed to present interchange plans

Project team members, identified in the Statement of Qualifications, shall not be modified in the Technical Proposal without written approval of the Department. Any such request should be sent to the attention of Mr. Randy Garris, PE, at the address below:

NCDOT- Contract Standards and Development
Century Center Complex - Building B
1020 Birch Ridge Drive
Raleigh, NC 27610

PRICE PROPOSAL

Price Proposals shall be submitted in a sealed package. The outer wrapping will clearly indicate the following information:

Price Proposal
Submitted By: (Design-Build Team's Name)
Design-Build Team Address
Contract Number C 203433
TIP Number I-5110, R-2413A & R-2413B
Guilford County

Future I-73 from Joseph M. Bryan Boulevard / Airport Parkway Interchange to south of US 220

The Price Proposal shall be submitted by returning the Request for Proposals with the item sheets completed, and all required signatures and bonds. Failure to execute the required documents may render the Price Proposal non-responsive.

If delivered by mail, the sealed envelope shall be placed in another sealed envelope and the outer envelope addressed to the Contract Officer as stated in the Request for Proposals. The outer envelope shall also bear the statement "Price Proposal for the Design-Build of State Highway Contract No. C 203433".

EVALUATIONS

Decisions based on cost alone will not establish the design standards for the project. Technical Proposals shall address the technical elements of the design and construction of the project. The Technical Review Committee will consider the understanding of the project, the anticipated problems and the solutions to those problems, in addition to other evaluation criteria identified herein.

The Design-Build Team's Technical Proposal shall be developed using narratives, tables, charts, plots, drawings and sketches as appropriate. The purpose of the Technical Proposal is to document the firm's understanding of the project, demonstrate the Team's capabilities to complete the project, document their selection of appropriate design criteria and state their approach and schedule for completing all design and construction activities.

The review of design plans by the Department is not intended to reflect a reviewer's personal preferences, but rather to ensure that all contract requirements are met, sound engineering judgment is exercised by the Design-Build Team and that the Design-Build Team adheres to all referenced documents, including but not limited to, design standards, codes, memos and manuals. As such, the award of the Design-Build contract does not in any way imply that the NCDOT accepts the details of the Technical Proposal submitted by the Design-Build Team.

The Technical Proposal will be evaluated in each of the following major categories:

EVALUATION FACTORS	POINTS
1. Management	12
2. Responsiveness to Request for Proposal	35
3. Long Term Maintenance	7
4. Schedule and Milestones	25
5. Innovation	6
6. Maintenance of Traffic and Safety Plan	10
7. Oral Interview	5

TECHNICAL PROPOSAL EVALUATION CRITERIA

1. Management – 12 points

Design-Build Team Management

- Describe the Design-Build Team's concept of design management. The proposal shall identify key positions and subordinate organizational units.
- Describe the plan for the coordination of civil / structural, utilities, traffic maintenance, constructability and environmental responsibility.
- Provide a narrative description of the proposed location of the design office(s) and their respective responsibilities.
- Describe how the designs developed by different firms and offices will be integrated.
- Describe how design personnel will interface with the construction personnel.
- Describe the overall strengths of the Design Team and their ability to fulfill the design requirements of this project.
- List projects, including description and similarity to the subject project, that the Design-Build Team's designer(s) have developed Transportation Management Plans, Signing Plans and Traffic Signal Plans.

Quality Management

- Describe how the Design-Build Team will comply with the quality control requirements for both design and construction. Specifically, include a narrative describing the Design-Build Team's understanding of the Department's construction quality control philosophy for this project and how the Design-Build Team will implement it.
- The Design-Build Team should detail the number of inspectors they expect the Department to furnish, during various phases, to allow satisfactory progress of project construction.
- Describe any significant quality control issues experienced on NCDOT projects in the last ten years and how those issues will be addressed for this project.
- The narrative shall include both design and construction activities.

Construction Management

- Describe the Design-Build Team's concept of the project construction management organization and how it interrelates with the other elements of the Design-Build Team's organization for the project.
- Provide a brief narrative description of the Design-Build Team's proposed plan for performing construction on the project. This description shall include at least the following:
 - A construction organization chart for the project, showing the relationships between functions shown on the chart and the functional relationships with subcontractors.

- The chart shall indicate how the Design-Build Team intends to divide the project into work segments to enable optimum construction performance.
- Descriptions of those categories of work that the Design-Build Team anticipates will be performed by the Design-Build Team's own direct labor force and those categories that will be performed by subcontractors.
- Identify the subcontractor(s) that will be responsible for construction at stream mitigation sites.
- The Design-Build Team's plans and procedures to insure timely deliveries of materials to achieve the project schedule.
- Describe the overall strengths of the construction team and their ability to fulfill the construction and construction management requirements of this project.
- Describe the Design-Build Team's approach to site access and material staging.

2. Responsiveness to RFP – 35 points

Natural Environmental Responsibility

- Describe the Design-Build Team's approach to addressing environmental concerns within the project boundaries.
- Identify efforts to minimize impacts on wetlands, streams, riparian buffers and other environmentally sensitive areas. Describe any temporary impacts and associated minimization approaches.
- Describe the Design-Build Team's understanding of the overall approach to permitting and the Team's comfort level with obtaining the required permits within the allowed timeframe.
- Identify methods of construction in wetlands, streams and buffers.
- Describe any project / construction related Notice of Violations (NOV's) received by any team member within the last five years on projects in the United States and the disposition of each listed NOV.
- Describe the Design-Build Team's approach to Sedimentation and Erosion Control for the project.
- Describe the Design-Build Team's approach to and plan for On-Site Mitigation.
- Provide a narrative overview of the Design-Build Team's Vegetation Management Plan.

Design Features

- Show plan view of design concepts with key elements noted.
- Identify preliminary horizontal and vertical alignments of all roadway elements.
- Show mainline typical sections.
- Identify proposed deviations to the preliminary design provided by the Department.
- Identify proposed deviations to the signed and sealed Culvert Survey Reports, Bridge Survey Reports and / or bridge plans provided by the Department.

- Specify the mainline pavement Alternate chosen. The pavement Alternate chosen for the mainline will not be a part of the Technical proposal evaluation and the selection thereof will not impact the Technical Scores; although an alternate pavement design, as approved as an ATC, may be considered in the evaluation.
- Specify the pavement Option chosen for the mainline median and outside shoulders, if applicable.
- Specify the base option chosen (ABC or asphalt) for all -Y- Lines and ramps.
- If applicable, specify where all underlying longitudinal joints will be located and demonstrate how the underlying longitudinal joint location will minimize reflective cracking.
- If applicable, specify the extent of impacts to properties with contaminated soils, indicating the anticipated contamination excavation limits.
- Identify drainage modifications and designs to be implemented.
- Demonstrate how the proposed grades and drainage details will ensure sufficient permanent gravity driven drainage in the cut section in proximity of the taxiway bridge.
- Describe the anticipated impacts to the floodplain(s). Specifically, discuss the extent and limits of the rise in water elevation, identify potentially impacted insurable structures, specify areas anticipated to require additional surveys and estimate the anticipated additional right of way impacts outside the project construction limits.
- Identify the appropriate design criteria for each feature, if not provided herein.
- Identify any deviations, including proposed design exceptions, from the established design criteria that will be utilized. Explain why the deviation is necessary.
- Identify all bridge types to be constructed, including any special design features or construction techniques needed.
- Demonstrate how the proposed horizontal and vertical roadway alignments maximize the available useable land between Service Road -Y1C- and all other roadways.
- Provide the taxiway bridge design details.
- Provide a Preliminary Signing Concept that extends from the beginning of the project through the I-73 / NC 68 northern interchange and includes all new and modified overhead sign assemblies and ground mounted guide signs.
- Describe any geotechnical investigations to be performed by the Design-Build Team and note any deviations to NCDOT requirements for subsurface investigations noted in the Geotechnical Scope of Work.
- Describe how utility conflicts will be addressed and any special utility design considerations. Describe how the Design-Build Team's design and construction methods minimize the Department's utility relocation costs.
- Identify any special aesthetics considerations that will be part of the design. Reference the Structures Scope of Work for details on bridge aesthetic expectations.
- Identify the months the Department should schedule the I-5110 4B and 4C Meetings
- Describe how the design will affect the Department's right of way costs.
- Identify types of any retaining walls and / or sound barrier walls, if applicable.

3. Long Term Maintenance – 7 points

- Describe any special materials, not referenced elsewhere in this RFP, incorporated into the project that would result in long term reduction in maintenance.
- Describe any special designs or construction methods that would reduce future maintenance costs to the Department.
- Estimate a minimum ten-year cost saving resulting from incorporation of these special materials, design or construction methods into the project.

4. Schedule and Milestones – 25 points

- Provide a detailed schedule for the project including both design and construction activities. The schedule shall show the sequence and continuity of operations, as well as the month of delivery of usable segments of the project.
- The schedule shall also include the Design-Build Team's final completion date and, if proposed, their substantial completion date. **These dates shall be clearly indicated on the Project Schedule and labeled "Final Completion Date" and "Substantial Completion Date"**.
- The schedule shall also include the Design-Build Team's committed duration for Intermediate Contract Time #1 and Intermediate Contract Time #6.
- The Design-Build Team is encouraged to commit to an early date for completion of the taxiway bridge in the Technical Proposal. **To be considered in the Technical Proposal evaluation, self-imposed liquidated damages must be proposed in conjunction with an early completion date for the taxiway bridge.**

5. Innovation – 6 points

- Identify any aspects of the design or construction elements that the Design-Build Team considers innovative. Include a description of alternatives that were considered whether implemented or not.

6. Maintenance of Traffic and Safety Plan – 10 points***Maintenance of Traffic***

- Provide a Transportation Management Phasing Concept (TMPC).
- Describe any traffic control requirements that will be used for each construction phase.
- Describe how traffic will be maintained as appropriate and describe the Design-Build Team's understanding of any time restrictions noted in the RFP.
- Specifically describe how business, school and residential access will be maintained, if applicable.
- Identify any self-imposed liquidated damages and associated Intermediate Completion Time(s), if applicable.

- Describe how access from existing NC 68 to and from the airport entrance will be maintained during construction.
- Address how hauling will be conducted, including but not limited to, hauling of materials to and from the site and hauling of materials within NCDOT right of way.
- If a temporary portable barrier system will be utilized, provide the type and why it is needed.
- If temporary shoring will be required, provide the type and why it is required.
- Include all proposed road closures and / or offsite detours; reason for need and duration.
- Address where and how law enforcement officers will be used.
- Discuss how a potential delay in severing access to the landlocked parcels on Caindale Drive and Hollingworth Drive will be addressed and when this access will need to be severed.

Safety Plan

- Describe the safety considerations specific to the project.
- Discuss the Design-Build Team's overall approach to safety.
- Describe any proposed improvements that will be made prior to or during construction that will enhance the safety of the work force and / or travelling public both during and after the project construction.

7. Oral Interview – 5 points

- The Design-Build Team's Project Management Team shall present a brief introduction of the project team and design / construction approach.
- Introductory comments shall be held to no more than 30 minutes.
- The Department will use this interview to ask specific questions about the Team's Technical Proposal, background, philosophies and project approach.
- Presentation, questions and answers shall not exceed 90 minutes. No more than **12 people** from the Design-Build Team may attend.

The Department will use the information presented in the oral interview to assist in the Technical Proposal evaluation.

Additional Warranty and / or Guarantee

- **The Extra Credit for this project shall be a Maximum of 5 Points.**

A twelve-month guarantee as outlined in the *Twelve-Month Guarantee* Project Special Provision is required for this project. However, the Design-Build Team may provide additional warranties and / or guarantees at their discretion. The Design-Build Team may be awarded additional points as "extra credit" to be added to the Technical Score.

The Design-Build Team may provide warranties and / or guarantees for major components of the project. Examples of major components are pavements, bridge components and sign structures. If additional warranties and / or guarantees are offered, the Design-Build Team

shall indicate in the Technical Proposal the general terms of the warranties and / or guarantees, a list of the items covered, performance parameters, notification and response parameters for corrective action, and evaluation periods. The Department will be responsible for annual inspections of the components covered by all warranties and / or guarantees offered by the Design-Build Team that extend beyond the required Twelve-Month Guarantee. The warranties and / or guarantees shall also define how disputes will be handled. Prior to the first partial payment, the Design-Build Team shall submit a document that provides additional warranty /guarantee specifics in sufficient detail that allows the document to be made a part of the contract through supplemental agreement.

No direct payment will be made for warranties and / or guarantees. Payment will be considered incidental to the lump sum price for the contract.

SELECTION PROCEDURE

There will be a Technical Review Committee (TRC) composed of five or more senior personnel from involved engineering groups that will evaluate the Technical Proposal on the basis of the criteria provided in the Request for Proposals.

The selection of a Design-Build Team will involve both technical quality and price. The Technical Proposals will be presented to the TRC for evaluation. The TRC shall first determine whether the proposals are responsive to the requirements of the Request for Proposals. The Department reserves the right to ask for clarification on any item in the Technical Proposal. A written response to this request for clarification shall be provided to the Department prior to the opening of the Price Proposals. The contents of the written response may affect the Technical Review Committee's determination of the Technical Proposal's responsiveness and / or the overall evaluation of the Technical Proposal. If any commitments or clarifications provided in the written response conflict with the contents of the Technical Proposal, the contents of the written response will govern and be incorporated into the contract.

Each responsive Technical Proposal shall be evaluated based on the rating criteria provided in the Request for Proposals. The TRC will submit an overall consensus Technical Proposal score for each Design-Build Team to the State Contract Officer.

Quality Credit Evaluation Factors for Technical Proposals

Management	12
Responsiveness to Request for Proposal	35
Long Term Maintenance	7
Schedule and Milestones	25
Innovation	6
Maintenance of Traffic and Safety Plan	10
Oral Interview	5
Maximum Score	100

The State Contract Officer will use a table based on the maximum quality credit percentage to assign a Quality Credit Percentage to each proposal based on the proposal's overall Technical Score. The maximum quality credit percentage for this project will be **25%**. The Technical

Review Committee may elect to assign point values to the nearest one-half of a point (e.g. 90.5). In this event, the Quality Credit Percentage will be determined by linearly interpolating within the table entitled “Quality Credit Percentage for Technical Proposals”.

Quality Credit Percentage for Technical Proposals

Technical Score	Quality Credit (%)	Technical Score	Quality Credit (%)
100	25.00	84	11.67
99	24.17	83	10.83
98	23.33	82	10.00
97	22.50	81	9.17
96	21.67	80	8.33
95	20.83	79	7.50
94	20.00	78	6.67
93	19.17	77	5.83
92	18.33	76	5.00
91	17.50	75	4.17
90	16.67	74	3.33
89	15.83	73	2.50
88	15.00	72	1.67
87	14.17	71	0.83
86	13.33	70	0.00
85	12.50		

The maximum Technical Score, including any extra credit given for warranties or guarantees, shall not exceed 100 points in determining the Quality Credit percentage.

If any of the Technical Proposals are considered non-responsive, the State Contract Officer will notify those Design-Build Teams of that fact. The State Contract Officer shall publicly open the sealed Price Proposals and multiply each Design-Build Team's Price Proposal by the Quality Credit Percentage earned by the Design-Build Team's Technical Proposal to obtain the Quality Value of each Design-Build Team's Technical Proposal. The Quality Value will then be subtracted from each Design-Build Team's Price Proposal to obtain an Adjusted Price based upon Price and Quality combined. Unless all Proposals are rejected or the Department elects to proceed with the Best and Final Offer Process, the Department will recommend to the State Transportation Board that the Design-Build Team having the lowest adjusted price be awarded the contract. The cost of the Design-Build contract will be the amount received as the Price Proposal.

The following table shows an example of the calculations involved in this Process.

An Example of Calculating Quality Adjusted Price Ranking

Proposal	Technical Score	Quality Credit (%)	Price Proposal (\$)	Quality Value (\$)	Adjusted Price (\$)
A	95	20.83	3,000,000	624,900	2,375,100
B	90	16.67	2,900,000	483,430	2,416,570
C *	90	16.67	2,800,000	466,760	2,333,240
D	80	8.33	2,700,000	224,910	2,475,090
E	70	0.00	2,600,000	0	2,600,000
* Successful Design-Build Team – Contract Cost \$2,800,000					

Opening of Price Proposals

Prior to opening the Price Proposals, the State Contract Officer will provide to each Design-Build Team their Technical Score in a sealed envelope. The sealed envelope will contain that Team's score only.

At the time and date specified, the State Contract Officer will open the Price Proposals and calculate the percentage difference between the Price Proposals submitted and the Engineer's Estimate.

Should all of the Price Proposals be within an acceptable range or below the Engineer's Estimate the State Contract Officer will proceed to calculate the quality credit and publicly read the Price Proposal, Technical Score and Adjusted Price as outlined in the selection procedure above.

Should any one or more of the Price Proposals be within an acceptable range or below the Engineer's Estimate and the remaining Price Proposals exceed an acceptable range of the Engineer's Estimate the State Contract Officer will go to a separate location to calculate the quality credit and determine if the Design-Build Team with the lowest Adjusted Price is within an acceptable range of the Engineer's Estimate. Should the Price Proposal of the Design-Build Team with the lowest Adjusted Price be within an acceptable range of the Engineer's Estimate or below the Engineer's Estimate the State Contract Officer will proceed to publicly read the Price Proposals, Technical Scores and Adjusted Prices. Should the Price Proposal of the Design-Build Team with the lowest Adjusted Price exceed an acceptable range of the Engineer's Estimate the State Contract Officer will publicly read the Price Proposals only and the Department will then determine whether to proceed to request a Best and Final Offer (BAFO) as outlined below.

Should all Price Proposals submitted exceed an acceptable range of the Engineer's Estimate the State Contract Officer will publicly read the Price Proposals only. The Department will then determine whether to proceed to request a Best and Final Offer (BAFO) as outlined below.

In the event that the Department elects to not proceed with a Best and Final Offer (BAFO), then the State Contract Officer will schedule a date and time to publicly reiterate all Price Proposals, and read all Technical Scores and Adjusted Prices.

Provided the Department elects to proceed to request a Best and Final Offer (BAFO), at the date and time specified, the State Contract Officer will open the Best and Final Offer Price Proposals and proceed to publicly read all Price Proposals, Technical Scores and Adjusted Prices.

Best and Final Offer

In the event initial Price Proposals exceed an acceptable range of the Engineer's Estimate or if the Department feels it is necessary for any reason the Department may choose to make amendments to the details of the RFP and request a Best and Final Offer from all of the previously short-listed teams. Alternately, the Department may choose to redistribute to the short-listed Design-Build Teams another RFP for the project with no amendments to the RFP scope.

After receipt of the redistributed RFP, the Design-Build Team has the option of changing their Technical Proposal details. If the Design-Build Team changes any component of the Technical Proposal, the TRC will review those amended components of the Technical Proposal and reevaluate the scores accordingly. The Design-Build Team shall highlight the changes to bring them to the Department's attention. A revised total score will be calculated, if appropriate, based on these amendments to the Technical Proposal.

Additional oral interviews will not be held. The Design-Build Teams shall submit both a revised Price Proposal and a revised Technical Proposal (if applicable) at the time, place and date specified in the redistributed RFP. A revised Quality Credit Percentage (if required) and Adjusted Price will be determined. This will constitute the Design-Build Team's Best and Final Offer. Award of the project may be made to the Design-Build Team with the lowest Adjusted Price on this Best and Final Offer.

Stipend

A stipulated fee of **\$100,000** will be awarded to each short-listed Design-Build Team that provides a responsive, but unsuccessful, Design-Build Proposal. If a contract award is not made, all short-listed Design-Build Teams that provide a responsive Design-Build Proposal shall receive the stipulated fee. Once award is made, or a decision is made not to award, unsuccessful Design-Build Teams can apply for the stipulated fee by notifying the State Contract Officer in writing and providing an original invoice within 60 days of Award. If the Design-Build Team accepts the stipulated fee, the Department reserves the right to use any ideas or information contained in the Design-Build Proposal and / or Alternative Technical Concepts, whether incorporated into the Design-Build Proposal or not, in connection with any contract awarded for the project, or in connection with any subsequent procurement, with no obligation to pay additional compensation to the unsuccessful Design-Build Team. The stipulated fee shall be paid to eligible Design-Build Teams within ninety days after the award of the contract or the decision not to award. Unsuccessful Design-Build Teams may elect to refuse payment of the stipulated fee and retain any rights to its Design-Build Proposal and the ideas and information contained therein.

In the event that the Department suspends or discontinues the procurement process prior to the Design-Build Proposal submittal date current at the time of the suspension, no stipulated fee will be paid.

ROADWAY SCOPE OF WORK (12-17-13)

Throughout this RFP, references to the preliminary roadway plans shall include the R-2413A & B Right of Way Plans and the I-5110 Hearing Map provided by the Department.

Project Details

- The Design-Build Team shall design and construct a four-lane divided facility from the Joseph M. Bryan Boulevard (SR 2085) / Airport Parkway interchange to south of US 220 in Guilford County. From the beginning of the project to approximately 0.9 mile north of NC 68, the minimum mainline median width shall be 70 feet wide. From approximately 0.9 mile north of NC 68 the median width shall transition to 46 feet and remain 46 feet to the end of the project. Unless noted otherwise elsewhere in this RFP, the Design-Build Team shall design and construct the -L- Line providing the same or better access, widening, improvements and level of service included in the preliminary roadway plans provided by the Department. The limits of -L- Line construction shall be of sufficient length to tie to existing based upon the current NCDOT guidelines and standards. Unless noted otherwise elsewhere in this RFP, the mainline shall be designed and constructed to meet a 70 mph design speed for a rolling rural freeway designed to interstate standards. The Design-Build Team shall provide all other design criteria in the Technical Proposal.
- Along the -L- Line, the Design-Build Team shall design and construct 14-foot outside shoulders, 12-foot of which shall be full depth paved shoulders, including all acceleration, deceleration and auxiliary lanes, and ramps / loops to the back of the gore (12-foot width). Where the mainline has a 70-foot median, the Design-Build Team shall design and construction 12-foot median shoulders, four-foot of which shall be full depth paved shoulders. Where the mainline has a 46-foot median, the Design-Build Team shall design and construction six-foot median shoulders, four-foot of which shall be full depth paved shoulders.
- Along -Y1- (NC 68), the Design-Build Team shall design and construct a four-lane divided facility with a 46-foot median and 12-foot outside shoulders, ten-foot of which shall be full depth paved shoulders. From the beginning of the -Y1- construction to approximately 2300 feet northward, the Design-Build Team shall design and construct six-foot median shoulders, four-foot of which shall be full depth paved shoulders. At that point, the Design-Build Team shall design and construct a transition from a median ditch section to a raised median with 2'-9" concrete curb and gutter that remains a raised median to the end of the -Y1- construction.
- **** NOTE ** Relocated Service Road -Y1C- bullet**
- Once the connection for I-73 at the Joseph M. Bryan Boulevard is complete and traffic placed on I-73, the Design-Build Team shall 1) remove the existing pavement for both Joseph M. Bryan Boulevard one-way roadways from the I-73 connection to the western limits of the proposed taxiway construction; and 2) remove the existing pavement for one

Joseph M. Bryan Boulevard one-way roadway from the western limits of the proposed taxiway construction to Burgess Road / North Regional Road. The Design-Build Team shall convert the remaining Joseph M. Bryan Boulevard one-way roadway to a two-lane two-way dead-end facility. The Design-Build Team shall be responsible for all removal, grading to drain, erosion and sedimentation control, seeding and mulching, and stabilization for the area where the pavement is removed.

- The Design-Build Team shall provide milled rumble strips along the mainline outside and median paved shoulders, including ramp and loop terminals, and acceleration, deceleration and auxiliary lanes, in accordance with the January 2012 Roadway Standard Drawings.
- The Design-Build Team shall coordinate with Projects R-2413C and U-2524BC design and construction to ensure accurate hydrology, capacity, and horizontal and vertical ties that adhere to the design criteria. The Design-Build Team shall not make any design or construction revisions that impact the design or construction of Projects R-2413C or U-2524BC without prior written approval from the Transportation Program Management Director. (Reference the *Cooperation Between Contractors* Project Special Provision found elsewhere in this RFP)
- The Design-Build Team shall design and construct one-lane ramps that provide a minimum 16-foot lane width. The Design-Build Team shall design and construct two lane ramps that provide minimum 12-foot lanes. All ramps shall have 14-foot outside shoulders, four-foot of which shall be full depth paved shoulders and 12-foot inside shoulders, four-foot of which shall be full depth paved shoulders.
- The Design-Build Team shall design and construct all directional ramps with a minimum of two 12-foot lanes. (Ramp -FLY- is the only ramp defined as a directional ramp on the preliminary roadway plans provided by the Department.) The minimum design speed for all directional ramps shall adhere to the middle range design speed noted in Table 10-1, *Guide Values for Ramp Design Speed as Related to Highway Design Speed* shown in AASHTO's *A Policy on Geometric Design of Highways and Streets* (2011). The Design-Build Team shall design and construct all directional ramps with a four-foot outside bridge rail offset and a 12' inside bridge rail offset.
- The Design-Build Team shall design and construct loops that adhere to Table 3-29, *Design Widths of Pavements for Turning Roadways*, shown in AASHTO's *A Policy on Geometric Design of Highways and Streets* (2011) - Case II / Condition C for one-lane loops; Case III / Condition C for two-lane loops. All loops shall have 12-foot outside shoulders, four-foot of which shall be full depth paved shoulders. All loops shall have 2'-6" curb and gutter along the inside edge of pavement, with a 14-foot berm. Excluding Loop -LP1D-, the minimum loop design shall be 30-mph with a minimum 230-foot radius. The minimum loop design for Loop -LP1D- shall be 30-mph with a minimum 220-foot radius.
- Unless accommodated on the preliminary roadway plans provided by the Department, the Design-Build Team will not be required to design or construct ramps or bridges to accommodate future loops.

- Unless noted otherwise elsewhere in this RFP, the Design-Build Team shall design and construct at-grade intersections with the lane configurations noted on the November 22, 2013 I-5110, R-2413 and R-2413B Congestion Management Schematic. All turn lane lengths shall meet the NCDOT standards where vehicle storage does not govern or the length required by the aforementioned recommendations, whichever is greater. This determination shall be made by calculating the recommended treatment for turn lanes, incorporating the minimum deceleration lengths, as defined in the NCDOT Roadway Design Manual (Reference Section 9-1, Figure F-4A) and comparing the calculated values with the NCDOT minimum turn lane lengths. At all intersections impacted by the Design-Build Team's design and / or construction, excluding resurfacing, the Design-Build Team shall accommodate the right turn maneuver in accordance with the NCDOT Roadway Design Manual (Reference Section 9-1, Figure F-4C).
- For all intersection / interchange design modifications, the Design-Build Team shall provide a traffic analysis that adheres to the January 1, 2012 Congestion Management Capacity Analysis Guidelines for the Department's review and acceptance. For intersections that overlap on the R-2413 and I-5110 Traffic Forecasts, the Design-Build Team shall use the R-2413 Traffic Forecast volumes in the aforementioned traffic analysis.
- The mainline grade point shall be located at the median edge of the lane. In a normal crown section, the mainline lanes shall slope in the same direction from the pavement edge adjacent to the median shoulder to the outside edge of pavement at a 0.02 cross slope.
- Unless noted otherwise elsewhere in this RFP, the Design-Build Team shall design and construct -Y- Lines, ramps, service roads and cul-de-sacs providing the same or better access, widening, improvements and level of service included in the preliminary roadway plans provided by the Department. The limits of -Y- Line and service road construction shall be of sufficient length to tie to existing based upon the current NCDOT guidelines and standards.
- Based on the preliminary roadway plans, the Department has completed the R-2413A, R-2413B and I-5110 and Service Road Studies. The Design-Build Team shall be responsible for all Service Road Studies for landlocked parcels created by variations to the Department's preliminary design. If required by the Service Road Studies prepared by the Design-Build Team, the Design-Build Team shall be responsible for the design and construction of all additional service roads, as well as all associated NEPA requirements. Based on the Service Road Studies prepared by the Department, the Design-Build Team shall be responsible for the following:
 - The Design-Build Team shall design and construct Service Road -Y1C- in accordance with the requirements noted below:
 - The Service Road -Y1C- northern terminus shall intersect NC 68 opposite the I-73 westbound exit ramp and entrance loop as a right-in / right-out facility. (The Design-Build Team shall design and construct an exclusive NC 68 northbound left turn lane that access Service Road -Y1C- westbound) However, the Service Road -Y1C- lanes shall line-up opposite the aforementioned ramp and loop to accommodate through movements without a skewed alignment.

- The Service Road -Y1C- southern terminus shall be located within the right of way acquired by the Department for the Family Trust of Johnny Odell Pitts, et al property (Parcel No. 937) without requiring additional right of way or easements from Parcel No. 937.
- Between the northern and southern termini, the Design-Build Team shall maximize the available useable land between Service Road -Y1C- and all other roadways. The Design-Build Team shall demonstrate how the proposed horizontal and vertical roadway alignments maximize the aforementioned available useable land in the Technical Proposal.
- It is anticipated that the three landlocked parcels on Caindale Drive and Hollingsworth Drive will be acquired, eliminating the need for a service road on I-5110. If the Department determines that the aforementioned parcels will not be acquired, the resulting required service road design and construction will be paid for as extra work in accordance with Subarticle 104-8(A) of the 2012 *Standard Specifications for Roads and Structures*. In the Technical Proposal, the Design-Build Team shall discuss how a potential delay in severing access to the landlocked parcels on Caindale Drive and Hollingsworth Drive will be addressed and when this access will need to be severed.
- The mainline is a full control of access facility. The Design-Build Team shall bring to the Transportation Program Management Director's attention any deviations from the proposed control of access shown on the preliminary roadway plans provided by the Department. The proposed right of way and / or control of access limits may deviate in proximity to cultural, historic, or otherwise protected landmarks, including cemeteries, to eliminate / minimize impacts. Prior to negotiating right of way, easements and / or control of access with property owners, the Design-Build Team shall delineate the proposed acquisitions on the Right of Way Plans developed by the Design-Build Team for the Department's review and acceptance.
- Prior to installation, the Design-Build Team shall be responsible for coordinating with, and obtaining approval from, the NCDOT for the woven wire fence placement. The Design-Build Team shall be responsible for installation of the woven wire fence along the control of access, including the replacement of all fence damaged during construction.
- Within the project limits, the Design-Build Team shall be responsible for the location and installation of all right of way monuments, including right of way monuments for those parcels that the Department has acquired right of way. (For those parcels that the Department has acquired right of way, the Department has installed iron pins.) The Design-Build Team shall replace all existing right of way monuments damaged and / or relocated during construction. For all aforementioned right of way monuments, the Design-Build Team shall install concrete monuments.
- The Design-Build Team shall not further impact any cultural, historical, or otherwise protected landmark or topographic feature beyond that shown on the preliminary roadway plans provided by the Department. The Design-Build Team shall not acquire right of way, easements or control of access from the aforementioned features unless shown on the preliminary roadway plans provided by the Department.

- The Design-Build Team shall not impact any cemetery located within the project limits. The proposed right of way, easement and / or control of access limits shall not encroach on any cemetery property.
- Excluding haul roads, the Design-Build Team shall design and construct resurfacing grades for all roadways impacted by construction. All resurfacing grades shall adhere to the design criteria and standards, provide all required pavement wedging (Reference the Pavement Management Scope of Work found elsewhere in this RFP) and adhere to the minimum requirements noted below:
 - The Design-Build Team shall resurface all lanes and paved shoulders of an undivided facility throughout the limits of proposed widening and construction.
 - Unless noted otherwise elsewhere in this RFP, for both divided and undivided facilities, the Design-Build Team shall resurface all lanes and shoulders with the outermost construction limits for all proposed widening and construction, including any gaps along the facility where construction activities are not required.
 - The Design-Build Team shall resurface each one-way roadway of a divided facility throughout the limits of the one-way roadway widening and construction and extend the resurfacing grade as required to provide the same resurfacing limits for the opposing direction of travel.
 - The Design-Build Team shall resurface all existing facilities to the limits of pavement marking obliterations / revisions.
- Excluding median locations where bridge piers, concrete barrier or overhead sign assemblies reduce the median shoulder width and / or stopping sight distance, design exceptions will not be allowed for the mainline, including all ramps and loops. NCDOT prefers not to have design exceptions for the -Y- Lines and service roads. If the Design-Build Team anticipates any design exceptions, they shall be clearly noted in the Technical Proposal. Prior to requesting / incorporating a design exception into the Final Plans, the Design-Build Team must obtain prior conceptual approval from the Transportation Program Management Director and the FHWA. If conceptual approval is obtained, the Design-Build Team shall be responsible for the development and approval of all design exceptions.
- At all intersections with restricted movements impacted by the Design-Build Team's design and / or construction methods, the Design-Build Team shall provide 5" keyed-in concrete monolithic channelization islands.
- The Design-Build Team shall provide turn-arounds on all roads to be dead-ended.
- The Design-Build Team shall inform the Transportation Program Management Director, in writing, of any proposed changes to the NCDOT preliminary design, previously reviewed submittals or the Design-Build Team's Technical Proposal and obtain approval prior to incorporation. The Design-Build Team shall note in the Technical Proposal any proposed

deviations to the design shown on the preliminary roadway plans provided by the Department. The Design-Build Team shall be responsible for any activities, as deemed necessary by the Department or the FHWA, resulting from changes to the NCDOT preliminary design, including but not limited to, public involvement, NEPA re-evaluation and / or coordination with other stakeholders. The Department shall not honor any requests for additional contract time or compensation for completion of the required activities resulting from changes to the NCDOT preliminary design.

- For all bridges over roadways, railroads and / or greenways, the Design-Build Team shall submit vertical and horizontal clearance design calculations at all critical points. The Design-Build Team shall submit post construction survey points for the aforementioned critical points that verify construction adheres to the vertical and horizontal clearances accepted by NCDOT. The Design-Build Team shall be responsible for all costs associated with correcting vertical and horizontal clearances resulting from any construction variation from the design accepted by the Department.
- As designed by the Department, sound barrier walls are not required. If the Design-Build Team revises the horizontal and / or vertical alignments such that greater noise impacts are possible on surrounding receptors, the Design-Build Team shall re-analyze and complete a revised noise report, if necessary for NCDOT and FHWA review and approval. The R-2413 and I-5110 Design Noise Reports will be provided to the Design-Build Team to assist in their determination of anticipated noise impacts on current receptors due to design changes. If sound barrier walls are required as a result of design deviations, the Design-Build Team shall be responsible for all costs associated with the walls, including but not limited to public involvement, geotechnical investigations, shaft and wall designs and construction.

General

- The design shall be in accordance with the 2011 AASHTO *A Policy on Geometric Design of Highways and Streets*, 2002 NCDOT *Roadway Design Manual*, including all revisions effective on the Technical Proposal submittal date, January 2012 NCDOT *Roadway Standard Drawings*, or as superseded by detail sheets located at <https://connect.ncdot.gov/resources/Specifications/Pages/2012-Roadway-Drawings.aspx>, *Roadway Design Policy and Procedure Manual*, *Roadway Design Guidelines for Design-Build Projects*, 2012 NCDOT *Standard Specifications for Roads and Structures* and the 2002 AASHTO *Roadside Design Guide*, 4th Edition and 2012 Errata.
- If the NCDOT *Roadway Design Manual*, the 2011 AASHTO *A Policy on Geometric Design of Highways and Streets*, the 2012 *Roadway Standard Drawings* and / or any other guidelines, standards or policies have desirable and / or minimum values, the Design-Build Team shall use the desirable values unless noted otherwise elsewhere in this RFP. Similarly, in case of conflicting design parameters, and / or ranges, in the various resources, the proposed design shall adhere to the most conservative values, unless noted otherwise elsewhere in this RFP.

- At all intersections, the Design-Build Team shall provide a maximum 0.05 roll-over between the outside edge of travel lane of the primary roadway and the beginning of the proposed grade for the secondary roadway.
- A sag vertical curve low point will not be allowed on any proposed bridge or approach slab.
- Excluding grades required solely to tie to existing, the minimum longitudinal grade shall be 0.30%.
- The Design-Build Team shall design and construct all driveways that adhere to the minimum requirements noted below:
- The Design-Build Team shall provide horizontal and vertical alignments for all driveways that require 100 feet or longer to tie to existing.
 - Excluding steeper grades required solely to tie to existing, the maximum driveway grade shall be 10%.
 - For shoulder sections, the minimum driveway turnout for residential and commercial properties shall be 16'-0" and 24'-0", respectively, or the existing width, whichever is greater.
 - For curb and gutter sections, the minimum driveway turnout for residential and commercial properties shall be 20'-0" and 28'-0", respectively, or the existing width, whichever is greater.
- The Design-Build Team shall contact Mr. Gary W. Thompson, North Carolina Geodetic Survey Director, prior to disturbing any geodetic monuments.
- The project shall follow the NCDOT-FHWA Oversight Agreement. Any changes that affect previous approvals shall be re-submitted by the Design-Build Team for FHWA acceptance.
- The Design-Build Team shall identify the need for any special roadway design details (i.e. any special drainage structures, rock embankment, rock plating, special guardrail, retaining walls, concrete barrier designs, etc.) and shall provide special design drawings. The Contract Standards and Development Unit may have special details available that can be provided to the Design-Build Team upon request.
- The Design-Build Team shall design and construct bridge rail offsets wider than the minimum widths noted below to provide adherence to all other design requirements, including but not limited to hydraulic spread and sight distance requirements:
 - For structures on the mainline, the minimum bridge rail offsets shall be as indicated in the NCDOT *Roadway Design Manual* or be equal to the approach roadway paved shoulders, whichever is greater. Narrower bridge rail offsets, based on bridge length, will not be allowed for structures on the mainline.

- For structures on -Y- Lines within an interchange, the minimum bridge rail offsets shall be as indicated in the NCDOT *Roadway Design Manual*, be equal to the approach roadway paved shoulders, or be six feet, whichever is greater. Narrower bridge rail offsets, based on bridge length, will not be allowed for structures on -Y- Lines within an interchange.
- For structures on -Y- Lines that are not located within an interchange, the minimum bridge rail offsets shall be equal to the approach roadway paved shoulders or be the width allowed in the NCDOT *Roadway Design Manual* for longer bridges, whichever is greater.
- Unless noted otherwise elsewhere in this RFP, all guardrail / guiderail placement shall be in accordance with the January 2012 NCDOT *Roadway Standard Drawings* and / or approved details in lieu of standards. Along all 3:1 fill slopes, constructed at fill heights that are equal to or greater than 12 feet, the Design-Build Team shall install guardrail. Along all fill slopes steeper than 3:1, constructed at fill heights that are equal to or greater than six feet, the Design-Build Team shall install guardrail. The guardrail / guiderail design shall be submitted for review with the Preliminary Plans submittal.
- Unless noted otherwise elsewhere in this RFP, the maximum allowable cut and fill slope shall be 2:1. (Reference the Geotechnical Engineering Scope of Work found elsewhere in this RFP) The slopes in the interchange areas shall follow the requirements set forth in the *Roadway Design Guidelines for Design-Build Projects* located on the Design-Build web site.
- Within the vehicle recovery area, the Design-Build Team shall design and construct single face concrete barrier in front of all sound barrier walls, retaining walls and all elements acting as a retaining wall, located on the outside shoulder in fill sections.
- Unless noted otherwise elsewhere in this RFP, the Design-Build Team shall design and construct all lane drops from the outside travel way.
- The Department has followed the Merger 01 Process used by the environmental agencies and the Department to obtain environmental permits. Any variations in the Department's proposed design and / or construction methods that nullify any Concurrence Points obtained or decisions reached between the Department and the environmental agencies; and / or require additional coordination with the environmental agencies shall be the sole responsibility of the Design-Build Team. The Department will not allow any contract time extensions or additional compensation associated with any coordination or approval process resulting from design and / or construction modifications.
- The Design-Build Team shall submit Structure Recommendations and Design Criteria for NCDOT and FHWA review and acceptance prior to submittal of the Preliminary Plans developed by the Design-Build Team. The Design-Build Team shall develop Structure Recommendations that adhere to the format noted in the March 25, 2003 and September 1, 2004 memos from Mr. Jay Bennett, PE, State Roadway Design Engineer. Unless noted otherwise elsewhere in this RFP, the design speed for all roadways shall be the greater of the minimum design speed for the facility type or the anticipated / actual posted

- speed plus five-mph. If a speed limit is not physically posted on an existing facility, General Statutes mandate the speed limit as 55 mph, resulting in a 60 mph design speed.
- Functional classifications that have a defined usable shoulder width shall have the appropriately wider overall shoulder width.
- The Design-Build Team shall be responsible for the evaluation of the algebraic difference in rates of cross slope (roll-over) between existing shoulders and roadways and the associated suitability for carrying traffic during construction, if necessary. In the event that the roll-over is found to be unacceptable for the proposed temporary traffic patterns, the Design-Build Team shall provide cross slopes that meet design standards and eliminate roll-over concerns.
- At all intersections impacted by the Design-Build Team's design and / or construction methods, excluding resurfacing, the following design vehicles shall be required for all turning movements:
 - WB-67 at all ramp / loop intersections with -Y- Lines (For side-by-side turning maneuvers, WB-67 for the outside movement only and SU-30 for inside movement)
 - WB-62 at all other intersections
- Unless noted otherwise elsewhere in this RFP, all roundabout(s) shall adhere to the design and operation parameters as detailed in *Roundabouts: An Informational Guide*, Second Edition (NCHRP Report 672). Prior to incorporation, the Design-Build Team shall provide a traffic analysis of the proposed roundabout(s), utilizing the 2035 projected traffic volumes and SIDRA Intersection 5.1 analysis software, for NCDOT review and approval. All roundabouts shall be designed and constructed to accommodate a WB-67.

NCDOT Information Supplied

- The NCDOT will provide copies of the R-2413 State Environmental Assessment, R-2413 State Finding of No Significant Impact, R-2413 Re-evaluation, I-5110 Environmental Assessment, I-5110 Finding of No Significant Impact, consultations, the latest list of environmental commitments and all pertinent approvals and correspondence. Unless noted otherwise elsewhere in this RFP, the Design-Build Team shall adhere to all commitments stated in these environmental documents.
- The NCDOT will provide electronic surveys to the Design-Build Team. Any supplemental surveys, including but not limited to additional topography, existing and proposed roadway, structure sites, underground and overhead utilities, existing and proposed drainage, wetland delineation, right of way, parcel names, and deed research and descriptions shall be the responsibility of the Design-Build Team to acquire and process. The Design-Build Team shall modify / incorporate boundary information used for the determination and valuation of property solely under the direct supervision of a Professional Land Surveyor registered in North Carolina. Known existing utilities have been located and will be included with the survey data. The Design-Build Team shall be responsible for confirming the location of the

utilities and the type / size of facilities. All supplemental Subsurface Utility Engineering (SUE) work shall be the responsibility of the Design-Build Team.

- The NCDOT will provide the I-5110, R-2413A and R-2413B Preliminary Plans developed by the Department. The Design-Build Team is cautioned that the preliminary designs shown on the aforementioned plans are provided solely to assist the Design-Build Team in the development of the project design. The Design-Build Team shall be fully and totally responsible for the accuracy and completeness of the project design, including, but not limited to, the use of the NCDOT's design, the use of portions of the NCDOT's design and / or modifications to the NCDOT's design.
- The NCDOT will provide final pavement designs. The Design-Build Team shall be responsible for all temporary pavement designs. (Reference the Pavement Management Scope of Work found elsewhere in this RFP)
- The NCDOT will provide a Geotechnical Subsurface Investigation. The Design-Build Team shall be responsible for any additional geotechnical information, all geotechnical recommendations, as well as supplemental structural and roadway investigations. (Reference the Geotechnical Engineering Scope of Work found elsewhere in this RFP)

PAVEMENT MANAGEMENT SCOPE OF WORK (1-7-14)

The Design-Build Team shall use one of the following alternates for the construction of the mainline (-L- Line) travel lanes:

Alternate 1

3.0" S9.5C
3.0" I19.0C
8.0" B25.0C
Subgrade Stabilization

Alternate 2

3.0" S9.5C
3.0" I19.0C
4.0" B25.0C
10.0" ABC
Subgrade Stabilization

Alternate 3

3.0" S9.5C
3.0" I19.0C
3.0" B25.0C
8.0" CTABC
Subgrade Stabilization

Alternate 4

11" Doweled Jointed Concrete
3.0" PADC
1.25" SF9.5A
Subgrade Stabilization

For Alternates 1, 2 and 3, the mainline outside and median paved shoulders shall use the travel lane pavement design.

For Alternate 4, the joints shall be uniformly spaced 15 feet apart and the mainline outside and median paved shoulders shall use one of the following alternates:

Asphalt alternate

3.0" S9.5C
3.0" I19.0C
Minimum 5.0" B25.0C

Concrete alternate

The median paved shoulders shall be 11" jointed concrete without dowels. The outside paved shoulders shall be a minimum 8" jointed concrete without dowels.

Median and outside shoulder joints shall match the adjacent travel lane joint spacing and location; and shall be anchored to the mainline travel lane pavement with tie bars.

The mainline travel lane and shoulder pavement designs chosen shall be used for the entire length of the project. The Design-Build Team shall specify the mainline travel lane and shoulder pavement alternates chosen in the Technical Proposal.

Addendum No. 1, January 14, 2014

C203433 (I-5110, R-2413A & R-2413B)

Pavement Management Scope of Work

Guilford County

Subgrade Stabilization shall be to a minimum depth of 8 inches for lime and 7 inches for cement. The type of subgrade stabilization and the amount of stabilizing agent shall be determined in accordance with the *Cement and Lime Stabilization of Subgrade Soils* Project Special Provision found elsewhere in this RFP.

Other pavement designs for this project shall be as listed in the table below:

LINE	Surface	Intermediate	Base	ABC	Stab.
-Y- (SR 1695)	2.0" S9.5B	-----	4.0" B25.0B	-----	No
-Y1- (NC 68)	3.0" S9.5C	3.0" I19.0C	4.0" B25.0C	8.0"	No
-RPA-, -RPAA-, -RPD- and -RPDA-	3.0" S9.5C	3.0" I19.0C	-----	10.0"	Yes
-FLY- @ -Y1- and -RP1C- @ -Y1-	3.0" S9.5C	3.0" I19.0C	-----	8.0"	Yes
-LP1A- and -LP1D- @ -Y1-	3.0" S9.5C	4.0" I19.0C	-----	8.0"	Yes
-RP1A- and -RP1D- @ -Y1-	3.0" S9.5C	2.5" I19.0C	-----	10.0"	Yes
-RP1B- @ -Y1-	3.0" S9.5C	2.5" I19.0C	-----	8.0"	Yes
-Y1A- (SR 2011), -Y1B- (SR 2016) and -Y4A-	3.0" S9.5B	2.5" I19.0B	4.0" B25.0B	-----	No
-Y2- (SR 2133)	3.0" S9.5B	4.0" I19.0B	-----	10.0"	No
-Y1C-, -Y3- (SR 2269), -Y4- (SR 2128), -Y5- (SR 2127), -RP6A- & -RP6D- @ -Y6- and -RP6B- & -RP6C- @ -Y6-	3.0" S9.5B	2.5" I19.0B	-----	8.0"	No
-Y6- (NC 150)	3.0" S9.5B	3.0" I19.0B	-----	8.0"	No
-Y7- (SR 2155), -Y6A-, -DR7A- and -DR7B-	3.0" S9.5B	-----	-----	*8.0"	No

* Prime coat required.

Warm mix asphalt will not be allowed on the -L- Line, ramps and loops.

The minimum depth for overlaying the existing pavement on the -Y- Lines and ramps shall be the full thickness of surface course as given in the above table. For the -Y- Lines and ramp pavement designs noted in the table above, the Design-Build Team may substitute an asphalt base course layer for an ABC layer. If such an alternative is proposed, the Design-Build Team shall use an asphalt base course mix that matches the asphalt base course mix specified for the roadway. If an asphalt base course mix is not specified, the Design-Build Team shall use B25.0B base course. The additional thickness of the asphalt base course, used as a substitute for the ABC layer, shall be equal to half of the proposed ABC thickness specified for the roadway. The Design-Build Team shall maintain the same pavement design throughout the -Y- Line and ramp construction limits. In the Technical Proposal, the Design-Build Team shall specify the base option chosen (ABC vs. asphalt) for all -Y- Lines and ramps. The Design-Build Team may substitute an asphalt base course layer for an ABC layer, as described above, for tie-ins and narrow widening.

On all ramps and loops, the adjacent through lane pavement design shall extend to the back of the gore (12-foot width).

Longitudinal joints of all surface course layers shall not be located in the final traffic pattern wheel path. The Design-Build Team shall indicate in the Technical Proposal where all underlying longitudinal joints will be located and demonstrate how the underlying longitudinal joint location will minimize reflective cracking.

Unless noted otherwise elsewhere in this RFP, the minimum widened width shall be six feet. The minimum widened width may be reduced to four feet only if the Design-Build Team demonstrates that their equipment properly compacts narrow widening and obtains prior Department approval. Tapers that tie proposed pavement to existing pavement are excluded from the narrow widening requirements noted above.

In areas where the existing -Y- Line paved shoulders are proposed to be incorporated into a permanent travel lane, the Design-Build Team shall be responsible for evaluating the existing paved shoulder regarding its suitability for carrying the projected traffic volumes. In the event that the existing paved shoulder is found to be inadequate, the Design-Build Team shall be responsible for upgrading the existing paved shoulder to an acceptable level or replacing the existing paved shoulder. The Design-Build Team shall submit their evaluation and proposed use of existing paved shoulders to the Transportation Program Management Director for review and acceptance or rejection.

The Design-Build Team shall be responsible for the design of all temporary pavements and for evaluation of existing shoulders and roadways regarding their suitability for carrying traffic during construction, if necessary. In the event that the existing shoulders and / or roadways are found to be inadequate for the proposed temporary traffic volumes and duration, the Design-Build Team shall be responsible for upgrading the pavement to an acceptable level. Prior to placing traffic on existing shoulders, the Design-Build Team shall remove the existing rumble strips. Temporary pavements shall be designed in accordance with the most recent version of the North Carolina DOT *Pavement Design Procedure*. Temporary pavement designs and associated calculations shall be submitted for review and comments using the contract submittal process. The expected duration for traffic on temporary pavement must be included as part of the submittal.

All driveways, up to the radius point, shall be constructed with the full-depth pavement design of the intersecting roadway. The entire impacted length of all non-concrete driveways with a 10% or steeper grade shall be constructed with 1.5" S9.5B and 8" ABC. Unless otherwise noted above, the Design-Build Team shall adhere to the following for all driveway construction:

- For existing gravel and soil driveways, use 8" ABC.
- For existing asphalt driveways, use 1.5" S9.5B and 8" ABC.
- For existing concrete driveways, use 6" jointed concrete reinforced with woven wire mesh.

The rate of application and the maximum and minimum thickness per application and layer shall be in accordance with the NCDOT Roadway Design Manual.

Excluding the high side of superelevated sections, the Design-Build Team shall design and construct median and outside shoulder drains and outlets at the locations noted below for the mainline asphalt pavement alternates:

- Throughout crest vertical curves located in cut sections
- Throughout all sag vertical curves
- Where the grade is less than 1%

Excluding the high side of superelevated sections, the Design-Build Team shall design and construct continuous median and outside shoulder drains and outlets for the mainline concrete pavement alternate.

Where installed on the outside shoulder, outlets shall be provided approximately every 300 feet. Where installed on the median shoulder, outlet increments shall not exceed 500 feet and all outlets shall be located at drainage structures. Shoulder drains shall be placed to drain the **entire travel lane pavement structure**. Shoulder drain design and outlet locations shall be submitted to the Transportation Program Management Director for review and acceptance.

Unless noted otherwise elsewhere in this RFP, the Design-Build Team shall pave from the edge of all paved shoulders to the face of all sound barrier walls and retaining walls located on the outside shoulder in fill sections and to the face of all guardrail with 6" of ABC (or 4" B25.0B or B25.0C), a split seal and at least one lift of surface course. If a split seal is not used, the ABC pavement design shall require prime coat at the normal application rate. In these areas, the Design-Build Team's installation of ABC or black base shall be consistent with the pavement type for the specific roadway. As an alternative to the above pavement design for paving the shoulders to the face of guardrail, the Design-Build Team may use the adjacent travel lane pavement design.

When a resurfacing grade ties to an existing curb, bridge and / or pavement, the Design-Build Team shall perform incidental milling such that the new pavement ties flush with the existing feature(s). When tying to the aforementioned feature(s), the Design-Build Team shall not reduce the minimum required surface layer pavement thickness noted above. At existing pavement ties, the Design-Build Team shall perform incidental milling for a minimum distance of 25 feet at bridge and six feet at curb sections. The Design-Build Team shall not perform incidental milling more than 72 hours prior to placement of the asphalt surface layer.

ALTERNATIVE TECHNICAL CONCEPTS

Alternative Technical Concepts (ATCs) that provide an alternate pavement design will be considered subject to the following restrictions:

- ATCs on pavement design shall not be submitted until after issuance of the Second Industry Draft Request for Proposals.
- Unless noted otherwise elsewhere in this RFP, the pavement design in the ATC shall be determined using one of the methods noted below:
 1. The NCDOT Interim Pavement Design Procedure dated April 1, 2000, as modified by Modifications to the April 2000 Interim Pavement Design Procedure dated November 2007 using a minimum 30 year design life.
 2. The AASHTOWare Pavement ME Design Software, Version 1.3, Build 1.3.28. Unless clear and convincing supporting documentation is provided, the pavement design in the ATC shall incorporate the design parameters noted below:

Parameter	Interstates and Other Freeways
Design Life	30 years
Reliability	90%
Asphalt Pavement	
Total Rutting	0.75 in
AC Rutting	0.50 in
Top Down Cracking	1000 ft/mile
Bottom Up Cracking	10%
IRI (30 year design life)	185 in/mile
Concrete Pavement	
Faulting	0.15 in
Slab Cracking	10%
IRI (30 year design life)	185 in/mile

- Regardless of the design method, the mainline pavement design in the ATC shall adhere to the requirements noted below:

Asphalt Pavement

- Full Depth Asphalt
 - Minimum 14” thickness
- Asphalt on ABC
 - Minimum 10” asphalt thickness
 - Minimum 8” ABC thickness
- Asphalt on CTBC
 - Minimum 9” asphalt thickness
 - 8” CTBC thickness

Concrete Pavement

- Concrete on stabilized subgrade
 - Minimum 11” concrete thickness
 - Type of subgrade stabilization and amount of stabilizing agent shall be determined in accordance with the *Cement and Lime Stabilization of Sub-grade Soils* Project Special Provision found elsewhere in this RFP
 - Minimum 8” lime subgrade stabilization thickness
 - Minimum 7” cement subgrade stabilization thickness
- Uniform 15-foot joint spacing
- Base shall be non-erodible and shall include a permeable drainage layer and a separator layer below the drainage layer (must drain the pavement structure while protecting the subgrade from moisture)
- The Design-Build Team may propose an ATC that violates the minimum thickness requirements noted above only if the Team proposes the use of innovative material(s).
- The pavement design in the ATC must be sealed by a professional engineer who has experience in pavement design. The ATC submittal shall include a brief resume or description of the designer’s pavement design experience.
- For all incorporated ATC pavement designs, the Design-Build Team shall include in the Technical Proposal a minimum three-year extension of the 12-month guarantee. (Reference the *Twelve Month Guarantee* Project Special Provision found elsewhere in this RFP)

ATCs complying with the above restrictions will be evaluated by a technical review panel in accordance with the usual ATC process. (Reference the *Alternative Technical Concepts and Confidential Questions* Project Special Provision found elsewhere in this RFP)

STRUCTURES SCOPE OF WORK (12-18-13)**Project Details**

The Design-Build Team shall be responsible for all structures necessary to complete the project, including at the following locations:

- Taxiway Bridge over -L-
- Dual Bridges on -L- over NC 68 at Pleasant Ridge Road (SR 2133)
- Flyover Bridge over -L- and NC 68
- Dual Bridges on -L- over NC 68 between Edgefield Road and Lebourne Road
- Bridge on Ramp RP1B over re-aligned Pleasant Ridge Rd.
- Grade separation bridge(s) at Alcorn Road (SR 2269) and -L-
- Grade separation bridge(s) at Bunch Road (SR 2128) and -L-
- Dual Bridges on -L- over Reedy Fork Creek
- Grade separation bridge(s) at Brookbank Road (SR 2127) and -L-
- Grade separation bridge(s) at Oak Ridge Road (NC 150) and -L-
- Grade separation bridge(s) at Deboe Road (SR 2155) and -L-
- All reinforced concrete box culverts required by the Design-Build Team's design
- Pedestrian Culverts (two locations)
- All retaining walls as required by the Design-Build Team's design

Department-Provided Sealed Structural Drawings

The Department will provide sealed structural drawings for the structures at the following locations:

- Dual Bridges on -L- over Reedy Fork Creek
- Six reinforced concrete box culverts (including two pedestrian culverts)

**** NOTE ** Deleted bullet on anticipated date of sealed structural drawings**

In the event the Design-Build Team chooses to modify the sealed structural plans provided by the Department, adherence to all guidelines / requirements stated, or included by reference, in this Request for Proposals shall be required. The Design-Build Team may redesign the Dual Bridges on -L- over Reedy Fork Creek to reduce the 12-foot median rail offsets to six feet, provided the aforementioned guidelines / requirements are adhered to, included but not limited to hydraulic spread and sight distance requirements.

For all provided sealed plans, the Design-Build Team is encouraged to construct according to these plans. The Design-Build Team may choose to modify these designs. In such case, the Design-Build Team shall assume full responsibility for the design of that work item and submit signed and sealed plans for Department review and approval. Intentions to do so must also be clearly noted in the Technical Proposal. Submittals for such design changes will be required to follow the Design-Build Submittal Guidelines as expected for other current Design-Build projects. No additional compensation will be provided and no extension of contract time will be granted due to the Design-Build Team's election to modify the sealed plans provided by the Department.

For the provided sealed Structural plans, the Design-Build Team shall coordinate revisions due to any plan errors with the Engineering Firm of Record through the Director of the Transportation Program Management. The Department is responsible for the accuracy and completeness of all signed and sealed plans provided by the Department and shall be fully liable for any additional costs due to errors in these plans; however, the Design-Build Team shall be responsible for examining the sealed plans and developing their own quantities to use in the formulation of their Price Proposal. No additional compensation will be provided as a result of an error or omission in the Structural plan quantities unless such a quantity error or omission is due to an error in the design or the sealed drawings.

Taxiway Bridge

The proposed Piedmont Triad International Airport taxiway bridge shall be fully constructed as part of this project. At a minimum, the bridge shall adhere to the following requirements:

- The design of the substructure and superstructure shall be in accordance with all Federal Aviation Administration Advisory Circulars, Orders and Notices. The bridge shall be designed for Airplane Design Group VI loading and Airplane Design Group V geometry.
- A fleet growth factor will not be required in the bridge design.
- Design criteria shall include, as a minimum, an impact factor of 30% and braking factor of 70% of gross weight. Design criteria shall also include a wind on live load applied to an assumed 5,000 sf surface area with the loading centroid located 17 ft. above the bridge deck and a wind load on the structure of 50 psf.
- A single bridge shall be constructed to cross Future I-73 as well as an access road on the south side of Future I-73 adjacent to the airport. The access road (to be constructed in the future) will have two 12 foot lanes and 6 foot shoulders. The bridge shall have a clear width of 214 feet.
- Retaining walls will be permitted in front of the taxiway end bents/abutments.
- The median pier shall be located such that two additional lanes with standard median shoulders in each direction can be constructed in the future without the need for a future design exception.
- The maximum grade allowed is 1.5% along the length of the taxiway bridge.
- The location, elevations, and alignment shall be in accordance with the Future Development Plan Taxiway Bridge over I-73 drawings dated August 2013 provided by the Department. Any revision to the location, skew, or alignment must be through an approved Alternate Technical Concept.
- The Design-Build Team shall anticipate close coordination with the Piedmont Triad International Airport to ensure that the bridge design satisfies the required design specifications and location, elevations, etc. to coincide with the future taxiway.
- The approach to the taxiway bridge shall be graded and seeded to a distance of 50' beyond the approach slabs or to the NCDOT right of way line, whichever is greater.
- Taxiway bridge approach slabs are required and shall be 30' in length as measured along the taxiway alignment.
- Conduits and cans for future lighting on the taxiway bridge shall be provided. The conduit shall be stubbed out 5 feet beyond the approach slab. Each conduit shall be 2"

diameter. One conduit shall be provided along the centerline and another conduit along each side of the bridge.

- Taxiway underpass lighting will be required on a system independent of the taxiway lighting. Reference the Lighting Scope of Work elsewhere in this RFP.

PTAA will adhere to the standard review timeframe stipulated in the NCDOT Design-Build Submittal Guidelines.

The Design-Build Team shall allow 30 days for all Federal Aviation Administration (FAA) reviews. The Design-Build Team is not responsible for any fees associated with FAA or PTAA reviews.

The Taxiway Bridge has been designated as a NCDOT trial project for aesthetics. As such, the Design-Build Team is encouraged to include aesthetic bridge treatments in their Technical Proposal and design. The Department has targeted a delta cost of approximately one-half percent (1/2%) of the total construction cost for the taxiway bridge to be dedicated to aesthetic bridge treatments. In accordance with the General Section, aesthetic bridge treatments will be a component of the Technical Proposal evaluations.

The Design-Build Team may elect to include aesthetic bridge treatments, such as, but not limited to, the following:

- Patterns, textures, etc. attached to, or inlaid on, the bridge superstructure or substructure
- Color coating of the concrete barrier rails and/or exterior girders
- Patterned, textured surface of any required retaining walls

After contract award, the Design-Build Team shall clearly present, with appropriate visual aids, the design intent, any aesthetic theme, and preliminary details for each design element for the taxiway bridge to the Department and PTAA officials. The Department will require 30 days to review these details to ensure that they are acceptable.

After approval of the bridge aesthetic concepts, the Design-Build Team shall include the accepted aesthetics details with the appropriate submittal of preliminary and final designs plans for each element. The Design-Build Team shall also submit for review any specifications, material requirements or construction processes needed to accomplish the aesthetic work along with the final design submittal for each element.

Bridge Specifics

The minimum vertical clearance for all new bridges over -L- (Future I-73) and access roads shall be 17'-0" for both concrete and asphalt pavements. The minimum vertical clearance for all other bridges shall be in accordance with the Roadway Design Manual.

The Design-Build Team shall design and construct 2-bar metal rail, on both sides of the Alcorn Road, Bunch Road, and Deboe Road bridges. To provide for future sidewalk, the rails shall be offset 7'-6" on the south side of Alcorn Road, the north side of Bunch Road, and the south side of Deboe Road. All other proposed bridge barrier rails shall be per Standard Drawing CBR1.

All bridges shall meet approved roadway typical sections and grades. Bridge geometry (width, length, skew, span arrangement, etc.) shall be in accordance with the accepted Structure Recommendations prepared by the Design-Build Team. All bridges over the proposed -L- Line shall be designed to accommodate a future eight through-lane section under the bridge without

requiring any future design exceptions. All bridges over NC 68 shall be designed to accommodate a future six through-lane section, with turn lanes, under the bridge without requiring any future design exceptions.

A live load rating chart for proposed girders shall be included with the highway bridge plans and shall state design assumptions and methodology used in the load rating calculations. The load rating shall be in accordance with the NCDOT *Structures Management Unit Manual* (including policy memos) and *AASHTO's Manual for Bridge Evaluation*.

The following will not be permitted on the project:

- Cored slab, box beam, fracture critical, cast-in-place deck slab and integral deck/girder bridges
- Precast barrier rails
- Empirical method for deck design.
- Precast Culverts
- Interior pile bents for grade separations.
- Monotube or cantilever DMS (if required on project) support structures.
- Attachment of sign structures to bridges.
- Bridge attachments (e.g. ITS conduit, waterlines) in the overhang of bridge structures
- Casting of conduit in the bridge deck or barrier rail for roadway bridges

General

The Design-Build Team's primary design firm shall be on the Highway Design Branch list of firms qualified for structure design and maintain an office in North Carolina.

Design shall be in accordance with the latest edition of the *AASHTO LRFD Bridge Design Specifications* (with exceptions noted in the NCDOT *Structures Management Unit Manual*), NCDOT LRFD Driven Pile Foundation Design Policy, NCDOT *Structures Management Unit Manual* (including policy memos) and NCDOT Bridge Policy Manual except as noted otherwise elsewhere in this RFP.

Reinforced concrete box culvert designs shall be in accordance with the latest edition of the *AASHTO LRFD Bridge Design Specifications*.

Construction and materials shall be in accordance with 2012 NCDOT *Standard Specifications for Roads and Structures*, NCDOT Structures Management Unit Project Special Provisions and NCDOT Structures Management Unit Standard Drawings.

Alternate designs, details or construction practices (such as those employed by other states, but not standard practice in NC) are subject to Department review and approval, and will be evaluated on a case by case basis.

GEOTECHNICAL ENGINEERING SCOPE OF WORK (12-10-13)**I. GENERAL**

All geotechnical data, tests, computations and supporting subsurface investigations and documentation submitted by the Design-Build Team shall be provided in English Units.

Obtain the services of a firm prequalified for geotechnical work by the NCDOT Geotechnical Engineering Unit at:

<https://partner.ncdot.gov/VendorDirectory/default.html>

The prequalified geotechnical firm shall prepare foundation design recommendation reports for use in designing structure foundations, roadway foundations, retaining walls, overhead sign structure, and temporary structures.

The Engineer of Record who prepares the foundation design recommendation reports shall be a Professional Engineer registered in the State of North Carolina who has completed a minimum of three geotechnical design projects of scope and complexity similar to that anticipated for this project using the load and resistance factor design (LRFD) method and in accordance with the latest edition of the AASHTO *LRFD Bridge Design Specification*. If the Engineer of Record cannot demonstrate the aforementioned LRFD experience, then the design must undergo a peer review by an individual with such experience. In such case, the reviewer must be a registered Professional Engineer, but not necessarily in the State of North Carolina. Prior to the first geotechnical design submittal, the Design-Build Team shall provide a letter to the NCDOT Transportation Program Management Director that documents the reviewer's LRFD experience for review and acceptance. Furthermore, with each geotechnical design submittal, the reviewer shall provide a sealed letter stating that he / she has carefully reviewed and approved the specific submittal details.

The prequalified geotechnical firm shall also determine if additional subsurface information, other than that required and noted elsewhere in this RFP, is required based upon the subsurface information provided by the NCDOT and the final roadway and structure designs. If a determination is made that additional subsurface information is required; the Design-Build Team shall use a prequalified geotechnical firm to perform all additional subsurface investigation and laboratory testing in accordance with the current NCDOT Geotechnical Engineering Unit *Guidelines and Procedures Manual for Subsurface Investigations*. Submit additional information collected by the Design-Build Team to the Geotechnical Engineering Unit for review. The Design-Build Team shall provide the final Subsurface Investigation report in electronic and hardcopy format to the NCDOT for its records.

A minimum of 2 standard penetration test (SPT) / rock core borings shall be required per bent for all bridges except dual bridges. A minimum of 3 SPT / rock core borings shall be required across the roadway typical section, at each bent location for dual bridges. All borings shall be located within 25 feet of the centerline of each bent location to be

counted for these minimum requirements. Extend all borings to a depth below the foundation element required to show a complete subsurface profile. The Design-Build Team shall be responsible for obtaining the borings noted above for all bents where subsurface information is not sufficient or is warranted by variability in the geology unless the prequalified geotechnical firm submits documented justification that the subsurface investigation provided by the NCDOT is adequate for design purposes and the justification is acceptable to the Department. Any deviations to the requirements noted above shall require acceptance from the NCDOT Geotechnical Engineering Unit prior to construction. Additional borings are not required at sites for which the Design-Build Team elects to use Department provided sealed structure plans.

The maximum spacing between borings for retaining walls shall be 200 feet, with a minimum of two borings; one at each end of the wall. Drill borings for retaining walls a minimum depth below the bottom of the wall equal to twice the maximum height of the wall or to SPT refusal.

The Design-Build Team is permitted to design bridges on this project using software that accounts for the structural effects of soil / pier interaction.

II. DESCRIPTION OF WORK

Unless otherwise noted herein, the Design-Build Team shall design foundations (except for sign foundations), embankments, slopes, and retaining walls in accordance with the current edition of the *AASHTO LRFD Bridge Design Specifications*, *NCDOT LRFD Driven Pile Foundation Design Policy*, all applicable NCDOT Geotechnical Engineering Unit Standard Provisions, *NCDOT Structures Management Unit Manual*, and *NCDOT Roadway Design Manual*. The *NCDOT LRFD Driven Pile Foundation Design Policy* is located on the NCDOT Geotechnical Engineering Unit's website at:

https://connect.ncdot.gov/resources/Geological/Pages/Geotech_Requirements_References.aspx

For *Geotechnical Guidelines For Design-Build Projects*, the Design-Build Team shall adhere to the guidelines located at the following website:

<https://connect.ncdot.gov/letting/Pages/Design-Build-Resources.aspx>

A. Structure Foundations

Permanent steel casings shall be required for drilled piers that are constructed in six inches or more of water. Permanent steel casings are required for drilled piers constructed on sloped stream banks subject to degradation from flooding.

For structure foundations impacted by scour, follow the Geotechnically Adjusted Scour Elevation (GASE) guidelines and Design Scour Elevation (DSE) procedures listed in the NCDOT Geotechnical Engineering Unit *Guidelines and Procedures Manual for Subsurface Investigations*. Provide calculations for these elevations with the Subsurface Investigation Report if one is required or with the Foundation Design Report if no additional borings were performed at the

structure. The GASE and DSE shall not be lower than the 100-yr hydraulic scour elevation shown on the accepted Bridge Survey Report.

When the weathered rock or rock elevation is above the 100-year hydraulic scour elevation, the 100-year design scour elevation may be considered equal to the top of the weathered rock or rock elevation, whichever is higher, and the 500-year design scour elevation may be set two feet below the 100-year design scour elevation.

End bent fill slopes up to 35 feet in height (defined as the difference between grade point elevation and finished grade at toe of slope) shall be 1.5:1 (H:V) or flatter. End bent fill slopes with heights greater than 35 feet shall be 2:1 or flatter. All end bent cut slopes shall be 2:1 or flatter. For 1.5:1 fill slopes, extend end bent slope protection from the toe of slope to berm and to 1.75:1 (H:V) slope or to the limits of the superstructure. For end bent cut slopes and for 2:1 or flatter end bent fill slopes, extend end bent slope protection from the toe of slope to berm and to the limits of the superstructure.

Analyze drilled pier and pile bent foundations using either LPile or FB-Pier. Design drilled piers and vertical piles with a sufficient embedment in soil and / or rock to achieve “fixity”.

For Box Culverts, the Design Build Team shall submit details for undercut of unsuitable material or recommendations for use of more than one foot of conditioning material to the NCDOT Geotechnical Engineering Unit, via the Transportation Program Management Director, for review and acceptance.

No raising of culvert headwalls / endwalls or the addition of retaining walls shall be used to reduce culvert length.

Add steel pile points to all piles to be driven with an estimated length of 20’ or less.

B. Roadway Foundations

Unless otherwise noted herein, all unreinforced proposed fill slopes shall be 2:1 (H:V) or flatter except bridge end bent slopes (see Section A – Structure Foundations). All proposed soil or rock cut slopes shall be 2:1 (H:V) or flatter, unless the slopes are designed with adequate reinforcement to provide the required stability. If steeper than 2:1 (H:V), reinforced cut or fill slopes may only be used if detailed design calculations and a slope stability analysis are submitted to the NCDOT Geotechnical Engineering Unit, via the Transportation Program Management Director, for review and acceptance prior to construction.

Provide design and construction recommendations to prevent slope surficial instability for all cut and fill slopes. Provide design and construction recommendations for all cut slopes that will intersect groundwater. Provide

subsurface drainage details for all cut slopes and grade points that intersect groundwater. Any subsurface and/or slope drainage that is designed shall be installed regardless of site conditions at the time of construction.

Material that does not meet the requirements of Table 1018-1 of the NCDOT 2012 *Standard Specifications for Roads and Structures* will be considered unsuitable material. Unsuitable unclassified excavation material may be used within embankments under medians of divided highways between the inside edges of pavements and not within the top six feet of embankments. All earth materials within the entire embankment cross-section shall be compacted in accordance of Section 235 of the NCDOT 2012 *Standard Specifications for Roads and Structures* regardless of source of material. The Design-Build Team may propose an Alternative Technical Concept to chemically modify unsuitable unclassified excavation material for use at locations other than outlined above.

Bridge approach embankments are defined as embankments within 250 feet of end bents. Design and construct bridge approach embankments such that no more than 1 inch of settlement will occur after the waiting period or monitoring ends. Bridge approach embankment settlement monitoring shall be required when a waiting period of more than one month is recommended in the foundation design recommendation reports. When embankment monitoring is required, construct the embankment and approach fill to the proposed roadway grade prior to monitoring. Use an appropriate method to monitor settlement across the length of the embankment (from toe to toe) such as settlement gauges, surveyed stakes on finished subgrade or other methods but submit documentation describing the method and procedures to the NCDOT Geotechnical Engineering Unit, via the Transportation Program Management Director, for review and acceptance prior to construction of the embankment. Bridge approach embankment waiting periods may not be ended until less than 1 inch of the anticipated settlement remains and less than 0.10 inch of settlement is measured over a period of four weeks. Do not drive piles or construct end bent caps until after bridge approach embankment waiting periods are complete.

Reinforced bridge approach fills in accordance with the NCDOT standard shall be required for end bents on all bridges.

Design and construct roadway embankments such that no more than 2 inches of settlement will occur following pavement construction. Embankment settlement monitoring shall be required for locations when a total settlement of more than 6 inches is calculated in the roadway foundations design recommendation report. Where computed settlement is greater than 6 inches, monitor settlement across the width of the embankment at maximum spacing interval of 250 feet by settlement gauges or other approved methods. Submit documentation describing the method and procedures to the Geotechnical Engineering Unit, via the Transportation Program Management Director, for review and acceptance prior to construction of the embankment. Roadway embankment waiting periods may not be ended until

less than 2 inches of settlement is anticipated following pavement construction and less than 0.10 inch of settlement is measured over a period of four weeks.

Soil improvement techniques to mitigate long term settlement problems or to transfer embankment load to a deeper bearing stratum are allowed at bridge approach or roadway embankments. Soil improvement techniques shall follow the current industry standard practices and the guidelines of *Ground Improvement Methods FHWA publication NHI-04-001* or *Geosynthetic Design and Construction Guidelines FHWA-HI-95-038*.

Undercut all unsuitable or unstable soils to the extent that is required to improve the stability of embankments or subgrades. Undercut unsuitable soils to a minimum depth of 3 feet below subgrade.

Provide subsurface drainage in accordance with NCDOT Standard Drawing 815.02, ditches of sufficient depth, or adjust the roadway profile to provide 6 feet of separation between groundwater and the lowest subgrade within any given cross-section.

Document and provide spring box or other subsurface drainage recommendations for all springs located under proposed fill sections.

If the top half of a new embankment that is at least ten feet high and 200 feet long is constructed with material that has more than 50%, by weight, passing the No. 200 sieve, the Design-Build Team shall add a high strength geotextile to the pavement structure in accordance with the *Geotextile for Pavement Stabilization* Project Special provision found elsewhere in this RFP. The aforementioned “top half” and ten-foot height shall be measured below the pavement structure and vertically from the toe of the embankment to the top of the outer edge of pavement, respectively.

C. Permanent Retaining Wall Structures

Retaining walls or abutment walls will not be allowed at any location where more than five feet of scour is calculated at the base of the wall.

For design and construction of mechanically stabilized earth (MSE) retaining walls, refer to the NCDOT *Policy for Mechanically Stabilized Earth Retaining Walls* which can be found at the NCDOT Geotechnical Engineering Unit's website at:

<https://connect.ncdot.gov/resources/Geological/Pages/Products.aspx>

Construct MSE walls using coarse aggregate if groundwater is above finished grade. Provide subsurface drainage at the back of the reinforced volume for all MSE retaining walls.

Design and construct permanent retaining walls, with the exception of gravity walls, in accordance with the applicable NCDOT Geotechnical Engineering Unit *Project Special Provisions*, which can be provided upon request by the Design-Build Team. Geotechnical Provisions and Notes can be found at the NCDOT Geotechnical Engineering Unit's website at:

https://connect.ncdot.gov/resources/Geological/Pages/Geotech_Provisions_Notes.aspx

For each retaining wall, with the exception of gravity walls, submit a wall layout and design submittal. The submittal shall include the following:

- Wall envelope with top of wall, bottom of wall, existing ground and finished grade elevations at incremental stations
- Wall alignment with stations and offsets
- Typical sections showing top and bottom of wall, drainage, embedment, slopes, barriers, fences, etc.
- Calculations for bearing capacity, global stability and settlement
- Details of conflicts with utilities and drainage structures
- Roadway plan sheets showing the wall (half size)
- Roadway cross sections showing the wall (half size)
- Traffic control plans showing the wall (half size)

Gravity walls shall be designed and constructed in accordance with the NCDOT Structure Standard Drawings and the NCDOT *2012 Standard Specifications*. Gravity walls shall be identified in the roadway foundation design recommendation report. Cast-in-place cantilever walls shall be designed and constructed in accordance with the NCDOT *2012 Standard Specifications*. Conceptual wall layouts and wall designs shall be submitted for NCDOT for review and acceptance.

Locate retaining walls at toes of slopes unless restricted by right of way limits. The Design-Build Team shall submit global stability calculations for slopes at retaining walls and obtain acceptance from the NCDOT prior to construction. Any slopes behind walls shall be 2:1 (H:V) or flatter.

Drainage over the top of retaining walls shall not be allowed. Sags in the top of walls are not permissible. Direct runoff above and below walls away from walls, if possible, or collect runoff at the walls and transmit it away. Curb and gutter or cast-in-place single faced barrier with paving up to the wall shall be required when runoff can not be directed away from the back or front of the wall. A paved concrete ditch with a minimum depth of six inches shall be required at the top of walls when slopes steeper than 6:1 (H:V) intersect the back of walls.

Precast or cast-in-place coping shall be required for walls without a cast-in-place face with the exception of when a barrier is integrated into the top of the wall. Extend coping or cast-in-place face a minimum of six inches above where the finished or existing grade intersects the back of the wall. A fence shall be

required on top of the facing, coping or barrier or immediately behind the wall, if there is no slope behind the wall.

Deep foundations shall be used for end bents when abutment retaining walls are employed. When using abutment retaining walls, design and construct the end bent and the wall independent of each other. When using abutment retaining walls, the end bent foundation shall be designed and constructed with one of the following deep foundations: (1) a single row of plumb piles with brace piles battered toward the wall, (2) a single row of plumb piles with MSE reinforcement connected to the back of the cap, (3) a double row of plumb piles, (4) integral abutment with a single row of plumb piles and no reinforcement connected to the back of the cap in accordance with FHWA GEC 11 pages 6-8 through 6-10, or (5) drilled piers. If fill is required around piles or drilled piers, install foundations before placing any fill. Wing walls independent of abutment retaining walls shall be required unless accepted otherwise by the NCDOT. Do not consider lateral support from any fill placed around drilled piers behind abutment retaining walls when analyzing end bent stability. All pile foundations for end bents with abutment retaining walls shall penetrate minimum 10 feet into natural ground. For bearing piles behind such retaining walls, the penetration can be reduced to 5 feet below the bottom of the wall provided the Design-Build Team analyzes and determines that the vertical piles are “fixed” in natural ground such that the decrease in pile embedment shall not significantly increase the top deflection under lateral loading. The calculations and supporting documentation for this analysis shall be submitted to the NCDOT for review and acceptance prior to construction.

D. Temporary Structures

Design temporary retaining structures, which include earth retaining structures and cofferdams, in accordance with current allowable stress design AASHTO *Guide Design Specifications for Bridge Temporary Works*, the *Temporary Shoring Special Provision*, and/or the applicable NCDOT *Project Special Provision*. The only submittal required to use the standard sheeting design is the “Standard Shoring Selection Form”.

Traffic Control barrier on top of walls shall be in accordance with the NCDOT Work Zone Traffic Control Unit details available upon request by the Design-Build Team. If anchored barrier is required, then anchor the barrier in accordance with NCDOT *2012 Roadway Standard Drawing* Detail No. 1170.01.

III. CONSTRUCTION REQUIREMENTS

All construction and materials shall be in accordance with the NCDOT *2012 Standard Specifications* and current NCDOT *Project Special Provisions* unless otherwise stated in this scope of work. The Design-Build Team shall be responsible for investigating, proposing and incorporating remedial measures for any construction problems related to foundations, retaining walls, subgrades, embankment settlement, slope global instability,

slope surficial instability, and construction vibrations. The NCDOT Geotechnical Engineering Unit shall review and accept these proposals.

The Design-Build Team shall be responsible for any damage or claim caused by construction, including, but not limited to, damage caused by vibration (see Article 107-14 NCDOT *2012 Standard Specifications for Roads and Structures*), and siltation or draining of ponds off the right-of-way. The Design-Build Team shall be responsible for deciding what, if any, pre and post-construction monitoring and inventories need to be conducted to satisfy their liability concerns. Any monitoring and inventory work shall be performed by a qualified private engineering firm experienced in the effects of construction on existing structures. At a minimum, perform pond preconstruction condition assessments as outlined in the NCDOT Geotechnical Engineering Unit *Guidelines and Procedures Manual for Subsurface Investigations*. Additionally, the Design-Build Team shall be responsible for monitoring the foundation of the existing water tower during bridge substructure construction adjacent to the tower to ensure stability.

The prequalified geotechnical firm that prepared the foundation designs shall review the settlement monitoring data a minimum of once a month and issue a letter prior to releasing the embankment or approach fill from monitoring. Monitoring may not be ended until less than 0.10 inch of settlement is measured over a period of four weeks. Submit the settlement monitoring data to the Transportation Program Management Director for review and acceptance prior to issuing the release letter.

The prequalified geotechnical firm that prepared the foundation designs shall review and approve all pile driving hammers and drilled pier construction sequences. After the prequalified geotechnical firm has approved these submittals, the Design-Build Team shall submit to the NCDOT for review and acceptance prior to beginning construction.

Perform hammer approvals with GRLWEAP Version 2010 or later and in accordance with the NCDOT LRFD Driven Pile Foundation Design Policy. The foundation design firm shall develop pile driving inspection charts or tables, based upon PDA testing and CAPWAP analysis, if applicable, for acceptance by the NCDOT prior to pile installation.

Construct piles in accordance with Section 450 of the 2012 *Standard Specifications for Roads and Structures*. Perform Pile Driving Analyzer (PDA) testing using a NCDOT prequalified company to develop pile driving inspection charts or tables. For each permanent bridge that includes driven pile bents or driven pile footings, perform a minimum of one (1) PDA test (dual bridges are counted as one structure) for each pile size, pile type (material or shape) and pile driving hammer combination. Additional PDA tests may be required based upon the AASHTO LFRD Bridge Design Specifications. If the bridge length with driven pile foundations is longer than 400 feet, perform an additional PDA test at every 400 feet interval. Provide additional PDA testing for any revisions to pile type, size or hammer previously approved. The locations of specific piles to be tested must be accepted by the NCDOT prior to any PDA test. Perform PDA tests in accordance with ASTM D 4945-89, Standard Test Method for High Strain Dynamic Testing of Piles and this scope of work.

Analyze data with the Case Pile Wave Analysis Program (CAPWAP), version 2006 or later. At a minimum, analysis is required for a hammer blow near the end of initial drive and for each restrike and redrive. Additional CAPWAP analysis may be required as determined by the Engineer.

Meet the guidelines for NCDOT PDA reports from the Geotechnical Engineering Testing Contract for PDA test reports. To obtain a list of pre-approved Geotechnical Engineering Testing Contract companies to perform PDA testing and guidelines for PDA test report, contact the Geotechnical Engineering Unit at 919-707-6850. PDA testing may be performed by a technician, but PDA testing must be overseen and the reports sealed by a Professional Engineer registered in the State of North Carolina. Submit a complete PDA report sealed by the professional engineer who performed the test to the foundation design firm. The foundation design firm shall develop pile driving inspection charts or tables for acceptance by the NCDOT prior to pile installation. Use current NCDOT inspection forms for drilled piers available on the NCDOT Geotechnical Engineering Unit's webpage. Construct and inspect drilled piers in accordance with Section 411 of the 2012 *Standard Specifications for Roads and Structures*. The Department will inspect drilled piers using the Shaft Inspection Device (SID) for any pours using the wet method of concrete placement and for any drilled pier excavations that cannot be visually inspected or have remained open longer than 24 hours that cannot be dewatered due to unstable soil or rock. The Design-Build Team shall notify Hesham El-Boulaki by e-mail (hel-boulaki@ncdot.gov) a minimum of five days prior to required SID testing, followed by a confirmation two days prior to required SID testing. The Design-Build Team shall notify Hesham El-Boulaki of all SID testing cancellations as soon as possible at the e-mail address noted above and at (919) 329-4200. Install Crosshole Sonic Logging (CSL) tubes in all drilled piers. CSL test a minimum of 25% of drilled piers at each bridge or one per bent, whichever is greater. If a CSL test identifies any defect in the drilled pier, the Department has the right to request additional CSL testing as needed. The Department will determine which piers will be CSL tested. Submit CSL test information and results to the Geotechnical Engineering Unit, via the Transportation Program Management Director, for review and acceptance.

For bridge foundation designs prepared by the Design-Build Team, the prequalified geotechnical firm that prepared the original design shall perform any changes to the foundation designs. All changes shall be based upon additional information, subsurface investigation and / or testing. Drilled pier tip elevations shall not be changed during construction unless the prequalified geotechnical firm that prepared the bridge foundation design redesigns the drilled pier from either an SPT / rock core boring, performed in accordance with ASTM standards at the subject pier location, or observations of the drilled pier excavation. If a drilled pier is designed based on a boring, do not drill a boring inside an open drilled pier excavation. Locate the boring within three pier diameters of the center of the subject pier and drill to a depth of two pier diameters below the revised tip elevation. If a drilled pier is redesigned based upon observations of the drilled pier excavation, the geotechnical engineer of record or their direct representative shall be present during the excavation to determine the actual subsurface conditions. Send copies of revised designs including additional subsurface information, calculations

and any other supporting documentation sealed by a professional engineer registered in the State of North Carolina to the NCDOT for review.

For construction of Dual Bridges on -L- over Reedy Fork Creek using Department provided sealed structure plans, the Department shall be responsible for adjusting drilled pier tip elevations downwards as necessary to accommodate subsurface conditions encountered at the time of drilling. The Department will respond with revised pier tip elevations within 24 hours of receipt of notification of subsurface rock conditions during drilling. Additional drilled pier greater than five feet length due to subsurface rock conditions will be paid for as extra work in accordance with Subarticle 104-8(A) of the 2012 Standard Specifications for Roads and Structures. The Department will not honor requests for compensation for drilled piers that are lengthened by five feet or less due to subsurface rock conditions or are lengthened more than five feet due to pier construction errors or stuck steel casings. No extension of contract time will be granted for changes in drilled pier tip elevations in either case.

Conduct proofrolling in accordance with Section 260 of the 2012 *Standard Specifications for Roads and Structures*. Proof roll areas again following the completion of corrections necessary to create a stable subgrade.

Send copies of any inspection forms related to foundations, settlement or retaining walls to the NCDOT for review.

HYDRAULICS SCOPE OF WORK (12-12-13)**General**

- The Design-Build Team's design shall be in accordance with criteria provided in the North Carolina Division of Highways "Guidelines for Drainage Studies and Hydraulics Design-1999", the addendum "Handbook of Design for Highway Drainage Studies-1973", North Carolina Department of Transportation *Best Management Practices for Construction and Maintenance Activities*-2003 and the North Carolina Division of Highways Hydraulics Unit web-site:

<https://connect.ncdot.gov/resources/hydro/pages/default.aspx>

- The Design-Build Team shall employ a private engineering firm to perform hydraulic design for all work required under this contract. The private engineering firm must be prequalified for hydraulic design work under the Department's normal prequalification procedures prior to the Technical Proposal submittal date.
- The Design-Build Team shall hold a pre-design meeting with the Transportation Program Management Director and Hydraulic Review Engineer upon acceptance of the Preliminary Roadway Plans developed by the Design-Build Team.
- The Design-Build Team shall design all storm drainage systems using Geopak Drainage.
- If the Design-Build Team modifies the design such that the R-2413A or R-2413B signed and sealed Culvert Survey Reports and / or Bridge Survey Reports are nullified, the Design-Build Team shall provide updated Culvert Survey Reports and / or Bridge Survey Reports in accordance with the Hydraulic Guidelines noted above for the Department's review and acceptance.
- In accordance with the Hydraulic Guidelines noted above, the Design-Build Team shall provide Culvert Survey Reports and Bridge Survey Reports for I-5110 structures for the Department's review and acceptance.
- If vertical abutments are proposed for bridges over waterways, the Design-Build Team shall provide abutment scour calculations, done in accordance with HEC-18, for the Department's review and acceptance.
- Spread will not be allowed in any permanent mainline travel lane. Spread shall not encroach more than two feet into a temporary mainline travel lane.
- Excluding the dual bridges over Reedy Fork Creek, the Design-Build Team shall analyze spread for all bridges identified in the Structures Scope of Work found elsewhere in this RFP and, as necessary, provide mitigation that eliminates spread in a travel lane. The Design-Build Team shall only be required to analyze spread for the dual bridges over Reedy Fork Creek, and as necessary, provide mitigation that eliminates spread in a travel lane, if the Design-Build Team modifies the signed and sealed structure plans provided by the

Department. The Design-Build Team shall adhere to the bridge drainage system requirements noted below:

- The Design-Build Team shall design bridge drainage without the use of Bridge Scuppers (open-grated inlets). If a closed drainage system is used on a bridge, the closed drainage system shall use vertical pipes at the flow line through the deck with no elbow and shall be consistent with that shown in the current NCDOT Stormwater Best Management Practices Toolbox.
- The Design-Build Team shall provide bridge drainage features that prevent direct discharge into waterways or onto any greenway, including the future greenway beneath the Reedy Fork Creek bridge, if applicable.
- In accordance with the NCDOT Best Management Practices Toolbox effective on the Technical Proposal submittal date, the Design-Build Team shall develop an I-5110 Stormwater Management Plan that, at a minimum, demonstrates the following:
 - To the maximum extent practicable, stormwater runoff shall be diverted away from surface waters
 - To the maximum extent practicable, on-site stormwater control measures shall be employed to minimize water quality impacts.
- The Design-Build Team shall assess the R-2413A and R-2413B Pre and Post Analyses and Stormwater Management Plan developed by the Department; and confirm that they are applicable to the Design-Build Team's design or revise as necessary. If necessary, the Design-Build Team shall prepare Pre and Post Analyses for increases in discharge and take appropriate action in accordance with the guidelines noted above to ensure that additional drainage is adequately handled. If necessary, the Design-Build Team shall modify the Stormwater Management Plans in their current format with appropriate changes. The Design-Build Team will not be required to update the existing Pre and Post Analyses or the Stormwater Management Plans to meet new guidelines/standards.

For I-5110, the Design-Build Team shall prepare Outfall Analyses and take appropriate action in accordance with the Hydraulic Guidelines noted above to make sure that additional drainage is adequately handled.

- The Design-Build Team shall remove or fill with flowable fill all pipes not retained for drainage purposes.
- The Department has obtained a Memorandum of Agreement (MOA) for the Reedy Fork Creek Tributary 7. If the Design-Build Team modifies the design and / or construction methods for the Reedy Fork Creek Tributary 7 box culverts such that the MOA is nullified, the Design-Build Team shall obtain an updated CLOMR or MOA in accordance with the requirements noted below. For all other FEMA regulated streams, including the CLOMR for

the Reedy Fork Creek Bridge, the Design-Build Team shall adhere to the following requirements:

- The Design-Build Team shall prepare a CLOMR or MOA package for the Department's submittal to the North Carolina Floodplain Mapping Program (NCFMP). The Design-Build Team shall obtain NCFMP approval prior to performing any construction activity in a FEMA regulated floodplain.
- The Design-Build Team shall notify the Transportation Program Management Director in writing of all structures that may require purchase due to a rise in the 100-year water surface elevation. The Department will be responsible for all surveys to ascertain insurable structures within the impacted area of the floodplain(s). The Design-Build Team shall discuss the extent and limits of the rise in water elevation in the floodplain(s), identify potentially impacted insurable structures, specify areas anticipated to require additional surveys and estimate the anticipated additional right of way impacts outside the project construction limits in the Technical Proposal. (Reference the Right of Way Scope of Work found elsewhere in this RFP)
- Excluding a CLOMR or MOA required for design and / or construction modifications for the Reedy Fork Creek Tributary 7 box culverts, the Department will be responsible for all fees associated with the CLOMR(s) and / or MOA(s). The Design-Build Team shall be responsible for all fees associated with a CLOMR or MOA required for design and / or construction modifications for the Reedy Fork Creek Tributary 7 box culverts.
- The Design-Build Team shall ensure that construction of all structures in FEMA regulated floodplains adheres to the approved CLOMR(s) and / or MOA(s). Within three months of completion of a structure in a FEMA regulated floodplain, the Design-Build Team shall provide sealed Record Drawings for the structure that verify construction adheres to the approved CLOMR or MOA. The Design-Build Team shall prepare a new FEMA model and / or package and be responsible for all associated costs resulting from any construction variation from the approved CLOMR(s) and / or MOA(s).
- The Department will allow no direct contact between the Design-Build Team and the NCFMP representatives. No contact between the Design-Build Team, the NCFMP and / or personnel under contract with NCFMP shall be allowed either by phone, e-mail, or in person, without Department representatives present. A representative from the Transportation Program Management Unit shall be included on all correspondence.
- For I-5110, the Design-Build Team shall conduct an interagency hydraulic design review meeting (4B) and an interagency permit impacts meeting (4C) prior to submittal of the environmental permit applications. All work resulting from the hydraulic design and permit reviews shall be the Design-Build Team's responsibility. The Design-Build Team shall provide hydraulic plans and permit impact sheets to the Transportation Program Management

- Director a minimum of five weeks prior to the appropriate interagency meeting. The Design-Build Team shall take minutes of the interagency meetings and provide them to the Department within three business days of the aforementioned meetings.
- Raised median island cuts will not be allowed.
- The Design-Build Team shall demonstrate in their Technical Proposal how the proposed grades and drainage details will ensure sufficient permanent gravity driven drainage in the cut section in proximity of the taxiway bridge. To facilitate drainage in this area solely during construction, the Design-Build Team will be allowed to use pumps temporarily.
- The Design-Build Team shall use a minimum ditch grade of 0.3% and avoid using ditches in wetlands

Project Details

- For I-5110, the Design-Build Team shall provide permit drawings, calculations and impact sheets, for the USACE 404 Permit, the NCDWQ Section 401 Certification and NCDWQ Riparian Buffer Authorization
- For R-2413A & R-2413B, the Design-Build Team shall provide revised permit drawings, calculations and impact sheets for modifications to the USACE 404 Permit and the NCDWQ Section 401 Certification as necessary. Currently, a NCDWQ Riparian Buffer Authorization for R-2413A and R-2413B is not required, except as noted otherwise elsewhere in the RFP. Reference the Environmental Permits Scope of Work.

Information Provided

- Signed and Sealed Culvert Survey Reports and Bridge Survey Reports for R-2413A and R-2413B.
- Submittal package for the Memorandum of Agreement (MOA) between NCDOT and NC Floodplain Mapping Program (NCFMP) for the Reedy Fork Creek Tributary 7. The MOA was approved May 23, 2013.
- Permit Applications for R-2413A and R-2413B
- R-2413A & R-2413B Pre and Post Analyses and Stormwater Management Plan
- R-2413A & R-2413B Red Line Drainage Plans

GEOENVIRONMENTAL SCOPE OF WORK (9-27-23)**I. DEFINITION**

For the purpose of this scope of work, contamination / contaminants are defined as any substance, which when discharged in any quantity may present an imminent and substantial danger to the public health or welfare. Petroleum is defined as any oil of any kind and in any form, including, but not limited to, crude oil, diesel fuel, fuel oil, gasoline, lubrication oil, oil refuse, oil mixed with other waste, oil sludge, petroleum related products or by-products, and all other liquid hydrocarbons, regardless of specific gravity, whether singly or in combination with other substances.

II. DESCRIPTION OF WORK

The Department cleared the project limits of fuel tanks and contaminated material as noted below. In the unlikely event that the contractor encounters contaminated materials, these materials will be handled in accordance with Article 107-25 of the Standard Specifications.

One former gas station (Northwest Superette) with known soil and groundwater contamination is within the project vicinity; Former Josephine Cox Smith Property NCDOT Parcel 936. This property was acquired by the NCDOT Right of Way Branch in fee simple.

Contaminated materials need only be removed from this site if excavation extends into the areas denoted as either Known Contamination or Potential Contamination as shown on the GeoEnvironmental MicroStation Reference File (I5110_Geo_env.dgn). Therefore, the Design-Build Team shall avoid or minimize excavation within the limits of the areas defined above. If the Design-Build Team's design is such that excavation is required in the areas of Known Contamination or Potential Contamination shown in the reference file, the extent of that anticipated excavation shall be noted in the Technical Proposal and included in the lump sum price bid for the entire project.

The Design-Build Team shall be responsible for the costs associated with the removal and replacement of any monitoring wells if the impacts are due to changes made t by the Design-Build Team to the Department's provided design. The Design-Build Team shall coordinate with the Resident Engineer and the NCDOT GeoEnvironmental Section to schedule removal and replacement of the monitoring wells. The NCDOT GeoEnvironmental Section will oversee any well replacement activities.

The NCDOT is considered the regulatory generator of hazardous materials excavated and removed from NCDOT property on this project.

III. INFORMATION PROVIDED BY NCDOT:

- Northwest Superette (Former Josephine Cox Smith Property) UST Closure Report, Prepared by Paragon Environmental Consultants
- GeoEnvironmental MicroStation Reference File (I5110_Geo_env.dgn)

IV. UNKNOWN CONTAMINATED SITES:

The Design-Build Team shall immediately notify the Department when the Design-Build Team's operations encounter or expose any abnormal condition which may indicate the presence of a hazardous, contaminated, and / or toxic material not previously identified. If the Engineer elects to have the Design-Build Team remove and dispose of contaminated material within an unknown contaminated site, the removal and disposal of this material shall be performed as extra work in accordance with Article 107-25 of the Standard Specifications.

SIGNING SCOPE OF WORK (1-9-14)**General**

The Design-Build Team shall prepare Signing Plans in accordance with the *Manual on Uniform Traffic Control Devices (MUTCD)* effective on the Technical Proposal submittal date, the 2011 *NC Supplement to the MUTCD*, NCDOT *Standard Specifications for Roads and Structures* (January 2012), the NCDOT *Roadway Standard Drawings* (January 2012) for the design and development of Signing Plans, the latest *Standard Specifications for Structural Supports for Highway Signs, Luminaires, and Traffic Signals* published by AASHTO, *Guidelines for Preparation of Signing Plans for Design-Build Projects*, the *Design-Build Submittal Guidelines* and the contract requirements contained herein.

Signing Plan Requirement

The Design-Build Team shall select a Private Engineering Firm (PEF) that has experience in designing and sealing Signing Plans for NCDOT on projects comparable to this project. The Technical Proposal shall list projects, where Signing Plans were developed by the PEF, including description and similarity to the subject project. The Design-Build Team shall provide a Preliminary Signing Concept that extends from the beginning of the project through the I-73 / NC 68 northern interchange and includes all new and modified overhead sign assemblies and ground mounted guide signs in their Technical Proposal.

The Design-Build Team shall provide a minimum of two advance guide signs for all interchange approaches.

Signs Furnished by Design-Build Team

The signs shall be furnished by the Design-Build Team according to the specifications provided by the NCDOT.

Signing Project Limits

The Design-Build Team shall locate, design, fabricate and install all signs required through the roadway construction limits of the mainline, all -Y- Lines and all cul-de-sacs.

The Design-Build Team shall also design, fabricate, and install one new overhead sign assembly, new signs, and overlay panels to existing signs required beyond the roadway construction limits of the mainline, all -Y- Lines and all cul-de-sacs to ensure adequate advance signage and spacing is provided. The following list includes the signing work required beyond the roadway construction limits:

- I-40 / I-73; I-73 / W. Friendly Avenue; I-73 / Bryan Blvd.
 - 24 existing overhead sign structures (19 full-spans, 5 cantilevers) will require “Martinsville” overlay.
 - Install 1 overlay on a ground mounted sign on Bryan Blvd.

- I-73 / US 220 (interchange north of Greensboro)
 - Install new signs on 6 existing overhead sign structures (5 full-spans, 1 cantilever).
 - Install 4 new ground mounted signs and supports.
 - Install 4 exit panels on ground mounted signs.
 - Install 1 overlay on a ground mounted sign.
- I-73 / US 220 (interchange south of Greensboro)
 - Install new signs on 4 existing overhead sign structures (4 full-spans).
- I-73 / Wendover Avenue
 - Install new signs on 2 existing overhead sign structures and remove lighting and walkways (2 cantilevers).
- I-73 / High Point Road
 - Install new signs on 5 existing overhead sign structures (4 full-spans, 1 cantilever).
- I-73 / I-85 and I-85 Business
 - Install new signs on 13 existing overhead sign structures (2 southbound I-85 Arrow-per-Lane signs spanning 5 lanes) and remove lighting and walkways (12 full-spans, 1 cantilever).
 - Install 1 new full span overhead sign structure and footings approximately 150' in front of the existing overhead (exit directional sign at "Exit 121" on I-85 Southbound) including Arrow-per-Lane sign on structure. New guardrail will be needed and existing guardrail will need to be modified.

Of the 55 total overhead sign structures affected beyond the roadway construction limits, 54 overheads (44 full-spans, 10 cantilevers) will be retained and will require existing sign removal. One new full-span overhead structure is required with associated guardrail changes.

Excluding the existing section of NC 68, the posted speed limits for I-73 and NC 68 shall be 65 mph. The posted speed limit for the existing section of NC 68 shall be 55 mph.

Sign Design

The Design-Build Team shall design, fabricate and install all other signs required for the mainline, including ramps / loops. The Design-Build Team shall design, fabricate and install all Type A, B and D signs and ground mounted signs, including all exit gore signs. The Design-Build Team shall be responsible for sizing, fabricating, locating and installing all Type E (warning and regulatory signs) and Type F signs (route marker assemblies).

The Design-Build Team shall design, fabricate and install mile markers every ½-mile on the mainline. All mile markers shall be installed on one U-channel post located on the outside shoulder for each direction of travel on the mainline. The mile marker designs and placement shall be in accordance with the Intermediate Enhanced Reference Location Signs (D10-5) referenced in the *Standard Highway Signs* (2004 Edition and the 2012 Supplement to the 2004 Edition) and the

revised NCDOT Roadway Standard Drawing 904D40, dated June 11, 2012. The aforementioned revised Roadway Standard Drawing may be referenced on the website noted below:

<https://connect.ncdot.gov/resources/safety/Pages/Signing-and-Delineation.aspx>

The Design-Build Team shall install 30" x 36" Chevron Alignment signs along all interchange loops and, as necessary, on ramps. The Design-Build Team shall install all Chevron Alignment signs on two U-channel posts that are spaced 24" apart. The Design-Build Team shall adhere to the Chevron Alignment sign height, spacing and orientation requirements specified in the MUTCD.

All sign designs shall be included in the Signing Plans. All sign designs shall be prepared using the latest version of GuideSign software. Refer to the Signing and Delineation Unit's main website below located under Private Engineering Firm by clicking on Seed Files (guidsign_english.dgn) for the latest GuidSign updates:

<https://connect.ncdot.gov/resources/safety/Pages/Signing-and-Delineation.aspx>

Sign Maintenance

The Design-Build Team shall maintain all existing signs during construction, including temporary installations of Guide Signs on supports to ensure signs are properly maintained and visible during project construction. The Design-Build Team shall be responsible for designing and installing all temporary sign supports.

Temporary Signs

The Design-Build Team shall be design, fabricate and install all temporary signs and supports. (Reference the Signing Requirements Section of the Transportation Management Scope of Work found elsewhere in this RFP for additional temporary signing requirements)

Interstate or US Route Designation

The Design-Build Team shall notify the State Signing and Delineation Engineer in writing prior to manufacturing signs that modify an Interstate or US route designation.

Sign Locations

The Design-Build Team shall be responsible for determining the station locations for all signs. To avoid sign placement in locations where their usefulness will be short-lived, the Design-Build Team shall coordinate the proposed sign designs and locations with the Department.

Ground Mounted Supports

Unless otherwise approved by the Engineer, Type A and B ground mounted signs on a freeway or expressway, installed on breakaway supports, shall be located a minimum of 30 feet from the edge of the outside travel lane to the nearest edge of the sign. All Type A and B ground mounted signs

on a freeway or expressway installed on non-breakaway supports shall be positively protected. All Type D, E and F signs shall be installed on U-channel posts in accordance with the NCDOT Roadway Standard Drawings.

NCDOT will provide the software for Type A and B ground mounted sign support designs. The Design-Build Team shall be responsible for all design, fabrication and installation of ground mounted supports and signs. Instructions for loading support design software will be made available upon request.

The Design-Build Team shall design, fabricate and install ground mounted sign supports in accordance with the revised NCDOT Roadway Standard Drawing 903D10, Sheet 2 of 3, dated March 8, 2012. The aforementioned revised Roadway Standard Drawing may be referenced on the website noted below:

<https://connect.ncdot.gov/resources/safety/Pages/Signing-and-Delineation.aspx>

Overhead Sign Assemblies

The Design-Build Team shall install signs on overhead sign assemblies in accordance with the following requirements:

- All primary guide signs on facilities that have three or more lanes per direction shall be installed on an overhead sign assembly.
- All freeway LANE ENDS warning signs shall be installed on an overhead sign assembly.
- All freeway EXIT ONLY signs shall be installed on an overhead sign assembly.
- All primary guide signs on freeway ramps that are four or more lanes at the -Y- Line intersection shall be installed on an overhead sign assembly.

The Design-Build Team shall design, fabricate and install overhead sign assemblies that meet all Department requirements. The wind speed for the overhead sign assembly designs shall be 90 mph. The Design-Build Team shall be responsible for calculating the windload area for the overhead sign assemblies. The windload area shall be flush with the sign height and width. When calculating the windload area, the Design-Build Team shall include all future signs and exit panels as part of the sign size.

The minimum vertical clearance beneath all overhead sign assemblies shall be 17 feet. For all overhead sign assemblies, the Design-Build Team shall submit documentation that verifies the actual vertical clearance at all critical points.

The Design-Build Team shall design, fabricate, and install overhead sign supports and foundations in accordance with the Foundations and Anchor Road Assemblies for Metal Poles, Overhead and Dynamic Message Sign Foundations and Overhead Sign Supports Project Special Provisions found elsewhere in this RFP. See ITS Scope of Work for type of support for Dynamic Message Signs.

Lighting will not be required on overhead sign assemblies.

The Design-Build Team shall prepare shop drawings for all proposed and modified overhead sign assembly structures for NCDOT review and acceptance. (Reference *Guidelines for Preparation of Signing Plans for Design-Build Projects* and 2012 *Standard Specifications for Roads and Structures* for additional requirements, including but not limited to shop drawing design and submittals requirements)

Overhead Sign Supports for Freeway Facilities

Except as allowed below, overhead sign supports shall be located a minimum of 40 feet from the edge of the outside travel lane to the center of the sign supports. To minimize right of way, utility, drainage and / or jurisdictional impacts, or to allow a cantilever overhead sign assembly in lieu of a full-span overhead sign assembly, the minimum 40-foot offset may be reduced. All overhead sign supports that are not located a minimum of 40 feet from the edge of the outside travel lane to the center of the sign support shall be protected by guardrail or other NCDOT approved positive protection barrier. When an overhead sign support is protected by guardrail, the face of the guardrail shall be located a minimum of eight feet from the center of the sign support.

The Design-Build Team shall provide the appropriate positive protection and drainage for all overhead sign median supports.

Overhead Sign Sheeting

The Design-Build Team shall design and fabricate overhead signs using Grade A retroreflective sheeting for the legends (text), shields and borders on Grade C retroreflective sheeting background except as noted below:

- Black legends, black borders and black arrows on overhead signs shall be black non-reflective sheeting.

For all existing overhead sign assemblies with lighting systems, the Design-Build Team shall remove and dispose of all signs, as well as the lighting system. The Design-Build Team shall replace the existing signs with signs that adhere to the requirements noted above.

Reference *Standard Practice for Retroreflectivity Sign Sheeting* under “Resource” on the NCDOT Signing and Delineation Unit’s website noted below:

<https://connect.ncdot.gov/resources/safety/Pages/Signing-and-Delineation.aspx>

Guardrail or Other Protection for Signs and Overhead Assemblies

The Design-Build Team shall be responsible for determining, designing and installing any protection for proposed and existing sign supports.

Signing Roadway Standards, Typical Sheets and Specifications

Signing roadway standards, typical sheets and specifications are located at the following website:

<https://connect.ncdot.gov/resources/safety/Pages/Signing-and-Delineation.aspx>

The Design-Build Team shall incorporate the appropriate information onto these sheets and submit them to the Transportation Program Management Director for review and acceptance.

Removal and Disposal of Existing Signs

The Design-Build Team shall be responsible for determining those existing signs that will no longer be needed upon completion of the project. The Design-Build Team shall be responsible for removal and disposal of these signs and supports. The Design-Build Team shall show and note these signs in the Signing Plans.

The Design-Build Team shall remove and dispose of existing overhead signs that are not retained or reinstalled on the project.

Construction Revisions

After submittal of RFC Signing Plans, all construction revisions shall be submitted to NCDOT for review and acceptance prior to incorporation.

TRANSPORTATION MANAGEMENT SCOPE OF WORK (12-19-13)**I. Laws, Standards and Specifications**

The Design-Build Team shall design the Transportation Management Plan (TMP) in accordance with the requirements of this RFP and the version of the standards listed below that are current at the time of the Technical Proposal submittal.

- Standard Specifications for Roads and Structures
- Roadway Standard Drawings
- NC Supplement to the MUTCD
- Manual on Uniform Traffic Control Devices (MUTCD)
- Roadway Design Manual
- Americans with Disabilities Act of 1990 (ADA)
- A Policy on Geometric Design of Highways and Streets
- Roadside Design Guide
- Standard Highway Signs
- Guidelines for Preparation of Traffic Control and Pavement Marking Plans for Design-Build Projects
- Design-Build Submittal Guidelines

References

The Design-Build Team shall use the references provided on the site below, as supplementary guidelines and requirements for the design and implementation of the Transportation Management Plans (TMPs).

WZTC Website: <https://connect.ncdot.gov/projects/WZTC/>

Transportation Management Plans

The Design-Build Team shall prepare Transportation Management Plans (TMP) that include Temporary Traffic Control Plans (TCP), an Incident Management Plan (IMP), a Traffic Operations Plan (TOP), the requirements of which are included in this Scope of Work, and a Public Information Plan (PIP) through coordination with the Department and in accordance with the Public Information Scope of Work found elsewhere in this RFP.

The Design-Build Team shall produce TMPs for each phase of work that impacts road users. The TMPs shall include details of all planned detours, traffic control devices, striping, and signage applicable to each phase of work. The information on the TMP shall be of sufficient detail to allow verification of design criteria and safety requirements, including, but not limited to, typical sections, alignment, striping layout, drop off conditions, and temporary drainage. The Design-Build Team shall develop TMPs that include procedures to communicate TMP information to the public about road and travel conditions within the work zone and affected roadway network.

A Transportation Management Phasing Concept (TMPC) shall be prepared by the Design-Build Team to present the Design-Build Team's approach to all areas covered under the TMP, including but not limited to hauling of materials to, from and within the project right of way (ROW). The Design-Build Team shall include the TMPC in the Technical Proposal. The Design-Build Team shall submit the TMPC for Department review and acceptance and shall address NCDOT comments on the TMPC prior to commencing production of the TMP for each phase of work or any construction. Any changes to the TMPC after acceptance by NCDOT shall require a submittal for review prior to any future phasing submittals.

The Design-Build Team shall select a Private Engineering Firm (PEF) that has experience developing TMPs on comparable projects for the North Carolina Department of Transportation (NCDOT) and shall list these comparable projects in the Technical Proposal.

In the event any self-imposed liquidated damages are included in the Technical Proposal an Intermediate Completion Time(s) shall be established and shall become part of the contract.

General Requirements

1. Maintain existing number of travel lanes, travel lane widths and shoulder widths on all roads **unless permitted otherwise** elsewhere in this Scope of Work. When more than one lane is operational in a given direction of NC 68, the Design-Build Team will be allowed to reduce the NC 68 travel lanes in that direction to a minimum 11-foot width.
2. **Once the connection for I-73 at SR 2085 (Joseph M. Bryan Blvd.) is complete and traffic placed on I-73, the Design-Build Team shall maintain a two-lane / two-way traffic pattern on SR 2085 (Joseph M. Bryan Blvd.) from the western limits of the proposed taxiway construction to Burgess Road / North Regional Road. (Reference the Roadway Scope of Work found elsewhere in this RFP)**
3. Traffic control devices shall be located a minimum 2-foot offset (shy distance) from the edge of an open travel lane.
3. Use of temporary barrier systems shall be shown on the Transportation Management Staging Concept. Temporary barrier systems shall be designed in accordance with the following requirements:
 - Determine the need for temporary barrier in accordance with the *FHWA Final Rule on Temporary Traffic Control Devices (23 CFR 630 Subpart K)*. Reference the NCDOT Work Zone Traffic Control website noted below for examples and Guidelines on the Use of Positive Protection in Work Zones.

<https://connect.ncdot.gov/projects/WZTC/Pages/Design-Resources.aspx>

- The Design-Build Team shall adhere to the Roadside Design Guide in determining the length of need, flare rate and clear zone. The Design-Build Team shall adhere to the possible deflection of the proposed temporary barrier system in accordance with NCHRP-350 deflections from crash testing. Providing less than the minimum deflection distance shall require the use of anchored temporary barrier systems in accordance with the NCDOT 2012 *Standard Specifications for Roads and Structures*.
4. The design speed for temporary alignments of NC and US routes shall not be lower than the current posted speed limit. The minimum allowable design speed for temporary alignments on secondary roads shall be the higher of 10 mph below the posted speed limit or 35 mph.
 5. The 2012 *Roadway Standard Drawing* No. 1101.11 shall be used to calculate the length of temporary merges for lane closures and temporary traffic shifts. For temporary traffic patterns that will remain in place for a period longer than three days, including but not limited to traffic shifts, merges and temporary alignments, breaks in the super elevation and / or crown breaks in a normal crown section will not be allowed within the shifting taper. Excluding the aforementioned temporary traffic patterns, breaks in the super elevation and / or crown breaks in a normal crown section shall only occur on a lane line or lane midpoint, and shall not exceed 0.04.
 6. Temporary traffic shifts requiring vertical grades shall be considered a temporary alignment. All temporary alignments shall adhere to the NCDOT Roadway Design Manual, 2011 AASHTO, A Policy on Geometric Design of Highways and Streets and the most current Highway Capacity Manual.
 7. Maintain access to all residences, schools, bus stops, mass transit facilities (park and ride lots), emergency services and businesses at all times. Prior to incorporation, obtain written approval from the Engineer on method to maintain access.
 8. Traffic traveling in the same direction shall not be split. (i.e. separation by any type of barrier, bridge piers, existing or proposed median, etc.).
 9. Prior to incorporation, obtain written approval from the Engineer for all road closures.
 10. Prior to incorporation, all offsite detour routes shall be approved in writing by the Engineer and adhere to the following requirements:
 - Except as allowed in **ICT #3, ICT #4, and ICT #6, NC 68 and / or SR 2085 (Joseph M. Bryan Blvd.)** shall not be closed.
 - The Design-Build Team shall be responsible for investigating all detour routes including but not limited to, analyzing traffic capacity, investigating impacts to emergency services and schools, analyzing design characteristics to ensure the design supports the traffic volumes (existing traffic volumes plus detoured traffic volumes), and investigating pavement structural adequacy including any bridge postings on the detour route.

- The Design-Build Team shall determine and provide improvements required to accommodate detoured traffic prior to utilizing detour routes.
 - Offsite detours that have non-signalized at-grade railroad crossings shall not be allowed.
 - Submit detour routes and all associated sign designs for review and acceptance prior to incorporation.
 - Off-site detours will be allowed for **NC 150 (Oak Ridge Rd.), SR 2127 (Brookbank Road), SR 2128 (Bunch Rd.), SR 2269 (Alcorn Rd.), and SR 2133 (Pleasant Ridge Rd.)** subject to the road closure restrictions listed in **Intermediate Contract Time #5** found elsewhere in the RFP.
 - Off-site detours will be allowed for **NC 68 and SR 2085 (Joseph M. Bryan Blvd.)** during girder installation over both roads subject to road closure restrictions listed in **Intermediate Contract Time #3** found elsewhere in the RFP.
 - Off-site detours will be allowed for **SR 2016 (Leabourne Rd.)**
 - Off-site detours will not be allowed for **SR 2155 (Deboe Rd.)**
 - Off-site detours will be allowed for **I-85 / I-73 / US 421 Southbound lanes (between Exit 122 and Exit 119)** during overhead sign installation subject to road closure restrictions listed in **Intermediate Contract Time #7** found elsewhere in the RFP.
 - All proposed road closures, detour routes, durations and justifications shall be incorporated into the Technical proposal. Such proposal will require approval by the Department.
 - Use only state maintained roads for off-site detour routes.
11. On all roadways within the project limits, the Design-Build Team shall provide safe access for wide-loads and oversized permitted vehicles through the work zone. Safe access shall entail, but is not limited to, a sufficient pavement structure (Reference the Pavement Management Scope of Work found elsewhere in this RFP), maintaining the existing vertical clearance of overhead structures, providing the required vertical clearance on proposed overhead structures and providing the minimum clear widths as follows:

Roadway	Minimum Clear Width
SR 2085 (Joseph M. Bryan Blvd.) and NC 68	18 feet
All other roadways	16 feet

12. The Design-Build Team shall coordinate with the Triad Traffic Management Center to manage traffic operations within the work zone and other roadways within the network that may be affected by the work zone activities. Coordination includes providing notification of planned lane or road closures, traffic detours, public information, traffic management, access management, incidents, etc.
13. On all roads, the Design-Build Team shall make all modifications to existing pavement markings, markers and / or signing located outside the project limits that are necessitated by the Transportation Management Plans.
14. The Design-Build Team shall take steps to minimize disruptions to existing roadway facilities during construction and shall demonstrate how the traffic control phasing, minimizes inconvenience to motorist on all roads.

General Lane Closure Restrictions

Lane Closure Notice (LCN)

1. The Design-Build Team shall issue a Lane Closure Notice (LCN) to NCDOT and affected government entities a minimum of twenty-one (21) calendar days prior to the publication of any notices or placement of any traffic control devices associated with lane closures, detour routing or other change in traffic control requiring lane closures. The Design-Build Team will be allowed to issue a single LCN for multiple / consecutive lane closures that occur in the same location.

For a LCN utilizing a non-NCDOT controlled facility, the Design-Build Team shall secure concurrence in writing from the controlling government entity. A LCN shall contain the estimated date, time, duration and location of the proposed work. The Design-Build Team shall keep NCDOT informed of any and all changes or cancellations of proposed lane closures prior to the date of their implementation.

If an emergency condition should occur, a LCN shall be provided to NCDOT within two (2) days after the event. For non-NCDOT controlled facilities, the Design-Build Team shall immediately notify the controlling government entity.

2. On two-lane / two-way facilities, the Design-Build Team shall not install more than one (1) mile of lane closure, measured from the beginning of the merge taper to the end of the lane closure. The Design Build Team shall not install more than two simultaneous lane closures and shall provide a minimum of four (4) miles between lane closures, measured from the end of one closure to the first sign of the next lane closure.
3. On multi-lane facilities, the Design-Build Team shall not install more than 2 miles of lane closure, measured from the beginning of the merge taper to the end of the lane closure. The Design Build Team shall not install more than two simultaneous lane closures in any one direction and shall provide a minimum of four (4) miles between lane closures, measured from the end of one closure to the first sign of the next lane closure.

4. The Design-Build Team shall remove lane closure devices from the lane when work is not being performed behind the lane closure or when a lane closure is no longer needed.
5. When barrier is placed on the roadway shoulder, the Design-Build Team shall install shoulder closure signs and devices in advance of the barrier using NCDOT 2012 Roadway Standard Drawings (RSDs).
6. When personnel and / or equipment are working within 15 feet of an open travel lane, the Design-Build Team shall close the nearest open shoulder using NCDOT 2012 RSDs, unless the work area is protected by an approved temporary traffic barrier or guardrail.
7. When personnel and / or equipment are working on the shoulder adjacent to an undivided facility and within 5 feet of an open travel lane, the Design-Build Team shall, at a minimum, close the nearest open travel lane using NCDOT 2012 RSDs, unless the work area is protected by an approved temporary traffic barrier or guardrail.
8. When personnel and / or equipment are working on the shoulder adjacent to a divided facility and within 10 feet of an open travel lane, the Design-Build Team shall, at a minimum, close the nearest open travel lane using NCDOT 2012 RSDs, unless the work area is protected by an approved temporary traffic barrier or guardrail.
9. When personnel and / or equipment are working within a lane of travel of an undivided or divided facility, the Design-Build Team shall, at minimum, close the lane using the appropriate roadway standard drawing from the NCDOT 2012 RSDs. The Design-Build Team shall conduct the work so that all personnel and / or equipment remain within the closed travel lane.
10. The Design-Build Team shall not perform work involving heavy equipment within 15 feet of the edge of travel way when work is being performed behind a lane closure on the opposite side of the travel way.

II. Project Operations Requirements

The following are Time Restrictions and notes that shall be included with the Transportation Management Plan General Notes, unless noted otherwise elsewhere in this RFP:

A. Time Restrictions

1. **Intermediate Contract Times #2 for SR 2085 (Joseph M. Bryan Blvd.), NC 68, SR 2133 (Pleasant Ridge Rd.), I-85, I-73, I-40, US 220, US 421, SR 1541 (Wendover Ave.) and NC 150 (Oak Ridge Rd.); including ramps and loops for Lane Narrowing, Lane Closure, Holiday and Special Event Restrictions**

At a minimum, the Design-Build Team shall maintain the existing number of lanes on **NC 68 and SR 2133 (Pleasant Ridge Rd.)** and shall not close or narrow (unless permitted otherwise elsewhere in this Scope of Work) a lane during the times below.

At a minimum, the Design-Build Team shall maintain two (2) lanes in each direction on **SR 2085 (Joseph M. Bryan Blvd.)** and shall not close or narrow a through lane during the times below unless permitted otherwise elsewhere in this Scope of Work.

At a minimum, the Design-Build Team shall maintain 16 foot wide ramps and loops on **SR 2085 (Joseph M. Bryan Blvd.)** and shall not close or narrow these ramps and loops beyond 16 feet, during the times below.

At a minimum, the Design-Build Team shall maintain the existing number of lanes on **NC 150 (Oak Ridge Rd.), I-85, I-73, I-40, US 220, US 421, and SR 1541 (Wendover Ave.)** and shall not close or narrow a lane during the times below.

Road Name	Day	Time Restrictions
NC 68, SR 2085 (Joseph M. Bryan Blvd.), SR 2133 (Pleasant Ridge Rd.) I-85, I-73, I-40, US 220, US 421, and SR 1541 (Wendover Ave.)	Monday through Friday	6:00 a.m. to 8:00 p.m.
	Saturday & Sunday	9:00 a.m. to 8:00 p.m.
NC 150 (Oak Ridge Rd.)	Monday through Friday	7:00 a.m. to 9:00 a.m. & 3:00 p.m. to 6:00 p.m.

The Design-Build Team shall not install, reset and / or remove any traffic control device during the times listed above.

In addition, the Design-Build Team shall not close or narrow a lane of traffic on **NC 68, SR 2085 (Joseph M. Bryan Blvd.), SR 2133 (Pleasant Ridge Rd.), I-85, I-73, I-40, US 220, US 421, SR 1541 (Wendover Ave.), and NC 150 (Oak Ridge Rd.);** detain the traffic flow or alter the traffic flow on or during holidays, holiday weekends, special events or any other time when traffic is unusually heavy, including the following schedules:

- (a) For New Year's between the hours of 6:00 a.m. December 31st to 8:00 p.m. January 2nd. If New Year's Day is on a Friday, Saturday, Sunday or Monday then from 6:00 p.m. the following Tuesday.
- (b) For Easter, between the hours of 6:00 a.m. Thursday and 8:00 p.m. Monday.

- (c) For Memorial Day, between the hours of 6:00 a.m. Friday and 8:00 p.m. Tuesday.
- (d) For Independence Day, between the hours of 6:00 a.m. July 3rd and 8:00 p.m. July 5th. If Independence Day is on a Friday, Saturday, Sunday or Monday, then between the hours of 7:00 a.m. the Thursday before Independence Day and 8:00 p.m. the Tuesday after Independence Day.
- (e) For Labor Day, between the hours of 6:00 a.m. Friday and 8:00 p.m. Tuesday.
- (f) For Thanksgiving Day, between the hours of 6:00 a.m. Tuesday and 8:00 p.m. Monday.
- (g) For Christmas, between the hours of 6:00 a.m. the Friday before the week of Christmas Day and 8:00 p.m. the following Tuesday after the week of Christmas Day.
- (h) For the NCAA Tournament, occurring at Greensboro Coliseum Complex between the hours of 6:00 a.m. the day before the start of the Tournament and 8:00 p.m. the following day after the end of the Tournament.
- (i) For the ACC Tournament, occurring at Greensboro Coliseum Complex between the hours of 6:00 a.m. the day before the start of the Tournament and 8:00 p.m. the following day after the end of the Tournament.
- (j) For the Furniture Markets, between the hours of 6:00 a.m. the Friday before the start of the Furniture Markets and 8:00 p.m. the Friday after the end of The Furniture Markets.
- (k) For the Wyndham Golf Tournament held in Greensboro, between the hours of 6:00 a.m. the Thursday before the start of the Tournament and 8:00 p.m. the Monday after the end of the Tournament

Liquidated Damages for Intermediate Contract Time #2 for the above lane narrowing, lane closure, holiday and special event time restrictions for I-85, I-73, I-40, US 220, and US 421 are \$2500.00 per 15-minute period or any portion thereof.

Liquidated Damages for Intermediate Contract Time #2 for the above lane narrowing, lane closure, holiday and special event time restrictions for SR 2085 (Joseph M. Bryan Blvd.), NC 68, SR 2133 (Pleasant Ridge Rd.) and SR 1541 (Wendover Ave.) are \$1500.00 per hour or any portion thereof.

Liquidated Damages for Intermediate Contract Time #2 for the above lane narrowing, lane closure, holiday and special event time restrictions for NC 150 (Oak Ridge Rd.) are \$500.00 per hour or any portion thereof.

2. Intermediate Contract Times #3 for SR 2085 (Joseph M. Bryan Blvd.) and NC 68, including ramps and loops for Road Closure Restrictions for Girder Installation

Unless permitted otherwise elsewhere in this Scope of Work, at a minimum, the Design-Build Team shall maintain the existing traffic pattern on **SR 2085 (Joseph M. Bryan Blvd.), and NC 68** and follow the road closure restrictions listed below. The Design-Build Team will be allowed to use road closures and offsite detours while installing girders over **SR 2085 (Joseph M. Bryan Blvd.) and NC 68**. When a road closure is used, the Design-Build Team shall provide an offsite detour and shall reopen the travel lanes by the end of the road closure duration. The Design-Build Team shall use offsite detours that are approved by the Department.

The Design-Build Team shall not close to traffic the following roads during the times noted below. Closure of these roads shall only be allowed for **girder installation** over these roads.

Road Name	Day	Time Restrictions
SR 2085 (Joseph M. Bryan Blvd.) and NC 68 including ramps and loops	Monday through Sunday	5:00 a.m. until 12:00 a.m. (midnight)

Proposed road closures for any road within the project limits shall be approved by the Engineer prior to incorporation in the Transportation Management Plans.

Liquidated Damages for Intermediate Contract Time #3 for the above road closure time restrictions for NC 68 and SR 2085 (Joseph M. Bryan Blvd.) are \$1000.00 per 15-minute period or any portion thereof.

3. Intermediate Contract Times #4 for SR 2085 (Joseph M. Bryan Blvd.), NC 68, I-85, I-73, US 220, and US 421 including ramps and loops for Road Closure Restrictions for Construction Operations

At a minimum, the Design-Build Team shall maintain the existing traffic pattern on **SR 2085 (Joseph M. Bryan Blvd.), NC 68, I-85, I-73, US 220, and US 421**; and follow the road closure restrictions listed below, unless permitted otherwise elsewhere in this Scope of Work. When a road closure is used, the Design-Build Team shall reopen the travel lanes by the end of the road closure duration to allow the traffic queue to deplete before re-closing the roadway.

The Design-Build Team shall not close any direction of travel on the following roads during the times noted below. Closure of these roads shall only be allowed for the installation of, **overhead sign panels over travel lanes and traffic shifts**. Maximum road closure duration of **thirty (30) minutes** shall be allowed for the roadways listed below:

Road Name	Day	Time Restrictions
SR 2085 (Joseph M. Bryan Blvd.), NC 68, I-85, I-73, US 220 and US 421 including ramps and loops	Monday through Sunday	5:00 a.m. until 12:00 a.m. (midnight)

Proposed road closures for any road within the project limits shall be approved by the Engineer prior to incorporation in the Transportation Management Plans.

Liquidated Damages for Intermediate Contract Time #4 for the above road closure time restrictions for I-85, I-73, US 220, and US 421 are \$2500.00 per 15-minute period or any portion thereof.

Liquidated Damages for Intermediate Contract Time #4 for the above road closure time restrictions for NC 68 and SR 2085 (Joseph M. Bryan Blvd.) are \$1000.00 per 15-minute period or any portion thereof.

4. Intermediate Contract Times #5 for NC 150 (Oak Ridge Road), SR 2127 (Brookbank Rd.), SR 2128 (Bunch Rd.), SR 2269 (Alcorn Rd.) and SR 2133 (Pleasant Ridge Rd.) for Road Closure Restrictions for Construction Operations

At a minimum, the Design-Build Team shall maintain the existing traffic pattern for all roadways and follow the road closure restrictions listed below. When a road closure is used, the Design-Build Team shall provide an offsite detour and shall reopen the travel lanes by the end of the road closure duration.

The Design-Build Team shall not close any direction of travel for the following roads during the times noted below.

Road Name	Day	Time Restrictions
SR 2133 (Pleasant Ridge Rd.), NC 150 (Oak Ridge Rd.), SR 2127 (Brookbank Rd.), SR 2128 (Bunch Rd.), and SR 2269 (Alcorn Rd.)	Monday through Friday	6:00 a.m. to 8:00 p.m.
	Weekends	From 8:00 p.m. Friday to 6:00 a.m. Monday

In accordance with the road closure time restrictions noted above, road closures will only be allowed for the following operations:

- Girder installations
- Installation of overhead sign assemblies over travel lanes
- Traffic shifts
- Pipe installations
- Tie-ins

Proposed road closures for any road within the project limits shall be approved by the Engineer prior to incorporation in the Transportation Management Plans.

Liquidated Damages for Intermediate Contract Time #5 for the above road closure time restrictions for NC 150 (Oak Ridge Road), SR 2127 (Brookbank Rd.), SR 2128 (Bunch Rd.), SR 2269 (Alcorn Rd.) and SR 2133 (Pleasant Ridge Rd.) are \$500.00 per 15-minute period or any portion thereof.

- 5. Intermediate Contract Times #6 for SR 2085 (Joseph M. Bryan Blvd.) Closure to complete tie-in between existing and proposed SR 2085 (Joseph M. Bryan Blvd.) extension to NC 68.**

The Design Build Team may close **SR 2085 (Joseph M. Bryan Blvd.)** to traffic up to Sixty (60) consecutive calendar days after and including the date the Design Build Team elects to close **SR 2085 (Joseph M. Bryan Blvd.)** to traffic just west of the **Airport Blvd. interchange**, provided the Design Build Team maintains a one lane / one way ingress to the airport from **NC 68** to existing **SR 2085 (Joseph M. Bryan Blvd.)** at all times during this Intermediate Contract Time #6. The Intermediate Contract Time shall be the number of calendar days proposed by the Design-Build Team in their Technical Proposal, and such number of calendar days proposed shall not be greater than sixty (60) calendar days.

Liquidated Damages for Intermediate Contract Time #6 for the above road closure time restrictions for SR 2085 (Joseph M. Bryan Blvd.) are \$2000.00 per one day period or any portion thereof.

- 6. Intermediate Contract Times #7 for I-85 / I-73 / US 421 Southbound lanes (between Exit 122 and Exit 119) for Road Closure Restrictions for Construction Operations**

At a minimum, the Design-Build Team shall maintain the existing traffic pattern for all roadways and follow the road closure restrictions listed below. When a road closure is used, the Design-Build Team shall provide an offsite detour and shall reopen the travel lanes by the end of the road closure duration.

The Design-Build Team shall not close any direction of travel for the following roads during the times noted below.

Road Name	Day	Time Restrictions
I-85 / I-73 / US 421 Southbound lanes	Monday through Sunday	5:00 a.m. until 12:00 a.m. (midnight)

In accordance with the road closure time restrictions noted above, road closures will only be allowed for the installation of overhead sign assemblies and sign panels over travel lanes.

Proposed road closures for any road within the project limits shall be approved by the Engineer prior to incorporation in the Transportation Management Plans.

Liquidated Damages for Intermediate Contract Time #7 for the above road closure time restrictions for I-85 / I-73 / US 421 Southbound Lanes are \$2500.00 per 15-minute period or any portion thereof.

B. Hauling Restrictions

The Design-Build Team shall adhere to the hauling restrictions noted in the NCDOT 2012 *Standard Specifications for Roads and Structures*.

The Design-Build Team shall conduct all hauling operations as follows:

- The Design-Build Team shall not conduct any hauling operations against the flow of traffic of an open travelway unless an approved temporary traffic barrier or guardrail separates the traffic from the hauling operation.
- The Design-Build Team shall not haul on NC 68, SR 2085 (Joseph M. Bryan Blvd.), or SR 2133 (Pleasant Ridge Rd.) during the holiday and special events time restrictions listed as Items (a) – (k) in Intermediate Contract Time #2, unless the hauling operation occurs completely behind temporary traffic barrier or guardrail and does not impact NC 68, SR 2085 (Joseph M. Bryan Blvd.) or SR 2133 (Pleasant Ridge Rd.) traffic operations.
- All entrances and exits for hauling to and from the work zone shall conform to the Roadway Standard Drawings.
- Haul vehicles shall not enter and / or exit an open travel lane at speeds more than 10 mph below the posted speed limit.
- Hauling access to the construction area on NC 68 and SR 2085 (Joseph M. Bryan Blvd.) will be allowed at the beginning and end of the project. Additional hauling access points on NC 68 and SR 2085 (Joseph W. Bryant Blvd.) shall be limited to one per direction, at a location chosen by the Design-Build Team and approved by the Department.
- Hauling entrances, exits and crossings shall be shown on the Transportation Management Plan.
- Hauling operations that perpendicularly cross a roadway shall require Traffic Control and are subject to the time restrictions, and holiday, holiday weekend and special event restrictions listed in ICT #2.

The Design-Build Team shall address how hauling will be conducted in the Technical Proposal, including but not limited to, hauling of any materials to and from the site and hauling material within the NCDOT right of way.

Single vehicle hauling shall not be allowed ingress and egress from any open travel lane during the following time restrictions:

Road Name	Day	Time Restrictions
NC 68, SR 2085 (Joseph M. Bryan Blvd.), and SR 2133 (Pleasant Ridge Rd.)	Monday through Friday	7:00 a.m. to 9:00 a.m. 4:00 p.m. to 6:00 p.m.

Multi-vehicle hauling shall not be allowed ingress and egress from any open travel lane during the following time restrictions:

Road Name	Day and Time	Restrictions
NC 68, SR 2085 (Joseph M. Bryan Blvd.), and SR 2133 (Pleasant Ridge Rd.)	Monday through Friday	7:00 a.m. to 6:00 p.m.

C. Pavement Edge Drop off Requirements

The Design-Build Team shall backfill at a 6:1 slope up to the edge and elevation of the existing pavement in areas adjacent to an opened travel lane that has an edge of pavement drop-off as follows:

- Elevation differences that exceed 2 inches on roadways with posted speed limits of 45 mph or greater and a paved shoulder four-foot wide or less.
- Elevation differences greater than 3 inches on roadways with posted speed limits less than 45 mph and with a paved shoulder four-foot wide or less.
- Refer to the current AASHTO *Roadside Design Guide* for proper treatment of all other conditions.

Do not exceed a difference of 2 inches in elevation between open lanes of traffic for nominal lifts of 1.5 inches. Install advance warning “UNEVEN LANES” signs (W8-11) 1000 feet in advance and a minimum of every half mile throughout the uneven area.

D. Traffic Pattern Alterations

The Design-Build Team shall notify the Engineer in writing at least twenty-one (21) calendar days prior to any traffic pattern alteration. (Reference the Public Information Scope of Work found elsewhere in this RFP for public information requirements).

E. Signing

The Design-Build Team shall install advance work zone warning signs when work is within 40 feet from the edge of travel lane and no more than three days prior to the beginning of construction.

When no work is being conducted for a period longer than one week, the Design-Build Team shall remove or cover all advance work zone warning signs, as directed by the

Engineer. Stationary work zone warning signs shall be covered with an opaque material that prevents reading of the sign at night by a driver traveling in either direction.

When portable work zone signs are not in use for periods longer than 30 minutes, the Design-Build Team shall lay the portable work zone sign flat on the ground and collapse the sign stand and lay it flat on the ground.

The Design-Build Team shall be responsible for the installation and maintenance of all detour signing and devices required for road closures. The Design-Build Team shall cover or remove all detour signs within and off the project limits when a detour is not in operation.

The Design-Build Team shall ensure proper signing (including but not limited to guide signs) is in place at all times during construction, as required by the *MUTCD*. All temporary signing shall be shown on the Traffic Control Plan or a Temporary Signing Plan to be approved by the Work Zone Traffic Control Section and/or the Signing and Delineation Unit.

F. Traffic Control Devices

The Design-Build Team shall use traffic control devices that conform to all NCDOT requirements and are listed on the Approved Products List. The Approved Products List is shown on NCDOT's website at:

<https://apps.dot.state.nc.us/vendor/approvedproducts/>

The use of any devices that are not shown on the Approved Product List shall require written approval from the Transportation Program Management Director prior to incorporation.

Channelizing device spacing shall not exceed a distance in feet equal to twice the posted speed limit. Channelization devices shall be spaced 10 feet on-center in radii. Channelization devices shall be 3 feet off the edge of an open travelway, when lane closures are not in effect. Skinny drums shall only be allowed as defined in Section 1180 of the NCDOT 2012 *Standard Specifications for Roads and Structures*.

Place Type III barricades, with "ROAD CLOSED" signs (R11-2) attached, of sufficient length to close entire roadway. Stagger or overlap barricades to allow for ingress or egress.

Place sets of three drums perpendicular to the edge of the travelway on 500-foot centers when unopened lanes are closed to traffic. These drums shall be in addition to channelizing devices.

When a CMS is placed within the clear zone, provide proper delineation and protection for the traveling public.

G. Temporary Pavement Markings, Markers and Delineation

The Design-Build Team shall show temporary pavement marking on the Traffic Control Plan that meet the requirements of the RFP and the *Guidelines for Preparation of Traffic Control and Pavement Marking Plans for Design-Build Projects*.

The Design-Build Team shall use pavement marking and marker products that conform to all NCDOT requirements and are listed on the NCDOT Approved Products List. The use of any devices that are not shown on the NCDOT Approved Products List shall require approval from the Transportation Program Management Unit Director prior to incorporation.

The Design-Build Team shall install pavement markings and markers in accordance with the NCDOT 2012 *Standard Specifications for Roads and Structures*, and in accordance with the manufacturer's procedures and specifications.

The Design-Build Team shall install temporary pavement markings that are the same width as existing pavement marking on all roadways. For roadways that do not have existing pavement marking, install temporary pavement markings that are the same width as required in the Pavement Marking Scope of Work for the final pavement marking.

The Design-Build Team shall install temporary pavement markings and temporary pavement markers on the interim surface or temporary pattern as follows:

Road	Marking	Marker
All Roads	Any Marking on the Approved Product List	Raised Temporary
All Structures	Cold Applied Plastic Type 4 - Removable Tape	Raised Temporary

The Design-Build Team may use any type of pavement markings on the NCDOT Approved Products List for temporary patterns. However, the Design-Build Team shall maintain a minimum retroreflectivity for pavement markings on all roads (existing and temporary markings) at all times during construction, as follows:

White:	125 mcd / lux / m ²
Yellow:	100 mcd / lux / m ²

When using Cold Applied Plastic (Type IV) pavement markings, place temporary raised markers half on and half off edgelines and centerlines to help secure the tape to the roadway. Markers shall be spaced the appropriate distance apart as described by the 2012 *Roadway Standard Drawing* 1250.01, Sheet 1 of 3.

Tie proposed pavement marking lines to existing pavement marking lines.

Remove / Replace any conflicting / damaged pavement markings and markers by the end of each day's operation.

Prior to opening a roadway to traffic on facilities that the installation of a proposed monolithic island has not occurred, outline the location of the proposed monolithic island with the proper color pavement marking.

The Design-Build Team shall not place temporary markings other than Cold Applied Plastic Type 4 – Removable Tape on any final pavement surface unless the temporary markings are placed in the exact location of the final pavement markings.

Unless noted otherwise in this RFP, removal of the temporary pavement markings on asphalt surfaces shall be accomplished by an NCDOT approved system to minimize damage to the road surface. Temporary pavement markings shall not be obliterated with any type of Black Pavement Markings (paint or other material). The Design-Build Team shall remove all temporary pavement markings without removing more than 1/32 inch of the pavement surface.

H. Temporary Traffic Signals

Use the following notes if the Design-Build team recommends using temporary signals for maintenance of traffic:

- Notify the Engineer in writing a minimum of two months before a temporary traffic signal installation is required.
- Shift and revise all signal heads as shown on the accepted Design-Build Signal Plans.

I. Miscellaneous

- Provide portable temporary lighting to conduct night work in accordance with the NCDOT 2012 *Standard Specifications for Roads and Structures*.
- Provide proper drainage for all temporary alignments and / or traffic shifts.
- The Design-Build Team shall coordinate with the Engineer where and how law enforcement officers will be used during construction.
- The Department intends to secure a \$250 speeding penalty ordinance for NC 68 and SR 2085 (Joseph M. Bryan Blvd.); the Design-Build Team shall sign accordingly.
- The Design-Build Team shall design traffic control plan for the posted speed limit; a speed reduction ordinance will not be allowed for this project.
- Coordinate with the Contractor and NCDOT Resident Engineer in charge of any project in the vicinity of this project for any work that may affect the construction and the temporary traffic control of this project.

- Coordinate with the Contractor and NCDOT Resident Engineer in charge of any project in the vicinity of this project to determine the placement of advance warning signs on all roads within the project limits.
- The Design-Build Team shall be responsible for all required temporary drainage and temporary shoring.

UTILITIES COORDINATION SCOPE OF WORK (12-12-13)

The Design-Build Team shall obtain the services of a Private Engineering Firm (PEF) knowledgeable in the NCDOT Utility Coordination Process involved with utility relocation / installation and highway construction. The Design-Build Team shall be responsible for coordinating all utility relocations, removals, and / or adjustments where the Design-Build Team and Utility Company, with concurrence from the Department, determine that such work is essential for highway safety and performance of the required highway construction. Coordination shall be for all utilities whether or not they are specifically identified in this scope of work and shall include any necessary utility agreements when applicable. NCDOT will be the approving authority for all utility agreements and approval of plans.

Cost Responsibility

The Design-Build Team shall be responsible for all costs associated with relocating water and sewer facilities, including re-establishing the connection between the private and public portions of the 8-inch VCP that is served by the manhole located at approximately Sta. 64+00 RT. FLY. Reference the file entitled S BS 436 Private Sewer Location.pdf. The Design-Build Team shall also be responsible for all costs associated with relocating or adjusting any utilities that have already been relocated once, or have relocation plans that have been authorized by the Department, to accommodate the design shown on the R-2413A and R-2413B Right of Way Plans provided by the Department. Distribution relocation plans for R-2413A and R-2413B have been received from Duke Energy. It is anticipated that NCDOT will issue authorization for this work to occur no later than December 2, 2013.

Unless otherwise noted above, the NCDOT will be responsible for all other non-betterment utility relocation cost when the utility company has prior rights of way / compensable interest. The utility company shall be responsible for the relocation costs if they can not furnish evidence of prior rights of way or a compensable interest in their facilities. The Design-Build Team shall be responsible for determining the cost responsibility for the utility relocations. The Design-Build Team shall be responsible for all costs associated with utility relocations due to haul roads and / or any other temporary conditions resulting from the Design-Build Team's methods of operation or sequence of work.

Project Details

The Design-Build Team shall be responsible for verifying the utility locations, type of facilities, and identifying the utility owners in order to coordinate the relocation of any utilities, known and unknown, in conflict with the project. The following utilities are known to be located within the project construction limits:

Utility Owner	Utility Type	Cost Responsibility
Duke Energy	Power	NCDOT
AT&T	Telecommunications	NCDOT / AT&T
City of Greensboro	Water and Sewer	City of Greensboro
Piedmont Natural Gas	Gas	NCDOT/Piedmont Natural Gas
Time Warner Cable	Cablevision	Time Warner Cable
DukeNet	Communications	DukeNet

The Department will permit the adjustment of location in the proposed Controlled Access fencing to enable existing Duke Energy transmission towers to remain in place provided that:

- The adjusted location of the fence is outside the clear recovery area of the roadway;
- No construction activities occur within 25 feet of the tower; and
- Access to the towers is provided in a form acceptable to Duke Energy.

Water and Sewer

The Design-Build Team shall maintain the location of the existing water tower located at the intersection of Regional Road and Caindale Drive. Further, the Design-Build Team shall be responsible for providing an access road to the water tower as specified below:

- The proposed all-weather access road shall be a minimum of 20 feet wide and consist of a landscape fabric underlayment with a six-inch layer of railroad ballast stone, topped with a four-inch layer of crush and run gravel.
- A gravel shoulder area adjacent to the proposed NC 68 paved shoulder to allow for deceleration of large equipment. The gravel shoulder shall be built with the same specifications as the access road.
- A vehicle turn-around area with a 42 foot outside turning radius shall be provided within the existing security fence.
- A vehicle turn-around area with a 20 foot radius located outside of the existing security fence.
- The access road shall be gated at the proposed NCDOT ROW line with a 24 feet wide gate consisting of 2-12 foot sections. The proposed gates shall match the existing gates.
- Maintain a minimum 15 foot vertical clearance along the access road and in proximity of the water tower.

The Design-Build Team shall relocate all existing water valves located within the existing and / or proposed right of way that are impacted by the design and / or construction methods to a location outside of the existing and / or proposed right of way. Unless the requirements noted below are adhered to, the Design-Build Team shall also relocate all existing water valves located within the existing and / or proposed right of way that are not impacted by the design and / or construction methods to a location outside the existing and / or proposed right of way:

- The Design-Build Team shall obtain approval from the NCDOT Utility Unit **and** the City of Greensboro, Water Resources Department for the existing water valve to remain within the existing and / or proposed right of way

- For safety and future maintenance, the Design-Build Team shall place a bollard over the existing water valve to mark its location

The Design-Build Team shall retain the existing fencing around the tank property site and provide access to the water tower during construction.

If the Design-Build Team's design and / or construction requires the relocation of existing water or sewer facilities, designs shall be coordinated with the NCDOT Utility Unit. All costs associated with the design and construction for relocation of these existing water and / or sewer facilities shall be the responsibility of the Design-Build Team and shall be included in the lump sum bid for the project. The Design-Build Team shall develop designs; prepare all plans for needed agreements and permits; submit permits directly to the agencies and obtain approval from the agencies. The Design-Build Team shall be responsible for all permit fees.

Designs shall be coordinated with the NCDOT Utility Unit. The Design-Build Team shall be responsible for submitting five (5) sets of 11 x 17 utility construction drawings to the State Utility Agent, via the Transportation Program Management Director, for further handling. Each set shall include a title sheet, plan sheets, profiles and special provisions if required. Once approved by the State Utility Agent, the plans, with the appropriate agreement, will be sent out to the City of Greensboro for their review and approval. The City of Greensboro will require any water and /or sewer relocations to be permitted prior to construction.

The relocation of all water and sewer facilities shall be done in accordance with the NCDOT policies and the latest City of Greensboro water and sewer design requirements / specifications. In the event of conflicting design parameters in the requirements noted above, the proposed design shall adhere to the most conservative values. The Design-Build Team may obtain the design requirements / specifications from the website noted below:

<http://www.greensboro-nc.gov>

Unless otherwise permitted by the City of Greensboro, all water tie-in work that requires interruption of service to and from the water tower shall be completed during the fall and winter and performed during a 4-hour period to start no earlier than 10:00 p.m. on any given night. However, the Design-Build Team shall coordinate the timing of such work with the City of Greensboro a minimum of two weeks prior to beginning the work.

The Design-Build Team shall anticipate that the construction permit issued by the City of Greensboro for any work that interrupts service to and from the water tower will contain conditions that reflect the following:

- Liquidated damages for not completing the work within a given 4-hour period; and
- A reserved right for the City to perform any work necessary to restore service to and from the water tower in the event that the Design-Build Team exceeds the 4-hour period and a provision for the Design-Build Team's reimbursement of all costs incurred by the City of Greensboro to perform such work.

If an interruption in any major (12 inch diameter or larger) water line service is caused by an unanticipated problem during construction and the Design-Build Team cannot fix the problem promptly, they will be required to alert the City of Greensboro for assistance. The Design-Build Team shall assume that any construction permit for major water line service work issued by the

City of Greensboro will contain a reserved right for the City to perform any work necessary to restore such service promptly and a provision for the Design-Build Team's reimbursement of all costs incurred by the City of Greensboro to perform such work.

Utility Relocation Plans

In the event of a utility conflict, the Design-Build Team shall request that the utility company submit relocation plans (Highway Construction Plans to be provided by the Design-Build Team to Utility Owners) that show existing utilities and proposed utility relocations for approval by the NCDOT.

The Design-Build Team shall submit Utility Relocation Plans to the NCDOT State Utility Agent, via the Transportation Program Management Director, for review and approval prior to relocation work beginning. The Design-Build Team shall submit (3) three copies of the Utility Relocation Plans when the utility company has prior rights. The Design-Build Team shall submit (5) five copies of the Utility Relocation Plans when the utility company is encroaching upon NCDOT right of way. The Design-Build Team shall also be responsible for submitting the appropriate agreements to be used with the Utility Relocation Plans (See Agreements found elsewhere in this scope of work). After the review process is complete, the NCDOT Utility Coordination Unit will submit one (1) copy of the Utility Relocation Plans, executed agreements and any necessary comments back to the Design-Build Team. The NCDOT Utility Coordination Unit will also submit a copy of the approved Utility Relocation Plans to the Department's Resident Engineer. If the Utility Relocation Plans are approved subject to changes, it shall be the Design-Build Team's responsibility to coordinate these changes with the appropriate utility company.

Compensable Interest

Typically, affidavits, recorded easements or NCDOT agreements can serve as evidence of prior rights. A compensable interest is identified as follows:

- (A) Existing or prior easement rights within the limits of the project, either by recorded right of way or adverse possession (Utility occupying the same location for twenty (20) plus years outside the existing highway rights of way).
- (B) Entities covered under *General Statute 136-27.1* and *136-27.2*. Statute requires the NCDOT to pay the non-betterment cost for certain water, sewer and gas relocations.
- (C) Utilities that have a joint-use agreement that constitutes a compensable interest with entities that have existing or prior easements rights within the project limits.

Work Performed by Design-Build Team for Utility Owners

If the Design-Build Team elects to make arrangements with a Governmental Agency or any other utility owner for proposed utility construction, in which the Agency / Utility Owner shall be responsible for the costs of work to be performed by the Design-Build Team, the Design-Build Team shall be responsible for negotiating all costs associated with the proposed construction.

Once the Design-Build Team and the Agency / Utility Owner agree on a plan and a lump sum estimated cost for the utility construction, the Design-Build Team shall be responsible for submitting five (5) sets of 11 x 17 utility construction drawings to the State Utility Agent, via the Transportation Program Management Director, for further handling. Each set shall include a title sheet, plan sheets, profiles and special provisions if required. Also, a letter from the Agency / Utility Owner agreeing to the plans and lump sum cost must accompany this package. The NCDOT will reimburse the Design-Build Team the estimated lump sum cost under a Supplemental Agreement. The necessary Utility Agreement to the Agency / Utility Owner for reimbursement shall be a two party agreement between the NCDOT and the Agency / Utility Owner; and will be developed and executed by the Department.

If the Design-Build Team is requested, in writing, by a utility company to relocate facilities not impacted by the project's construction, and / or upgrade or incorporate new facilities as part of the highway construction, designs shall be coordinated with the Utility Owner and NCDOT Utility Coordination Unit. The associated design and construction costs shall be negotiated and agreed upon between the Design-Build Team and the utility company. The Design-Build Team shall develop designs; prepare all plans for needed agreements and permits; submit permits directly to the agencies and obtain approval from the agencies. The Design-Build Team shall be responsible for all permit fees.

Cable TV

The cost in relocating CATV due to the highway construction shall be the responsibility of the CATV Company; however, under the following conditions the Design-Build Team shall bear the relocation expense:

- (A) If the CATV Company can validate a recorded easement for facilities outside the maintained NCDOT rights of way.
- (B) The adjustment is needed on existing utility poles to accommodate a proposed NCDOT Traffic Management System Fiber Optic Communication Cable Project.

The NCDOT will not permit CATV to place poles within the highway rights of way but will allow down guys for their facilities within the highway rights of way. Under most circumstances, the CATV Company will continue a joint-use attachment with the local Power and Telephone Company. If the CATV proposed relocation places buried facilities within the highway rights of way then plans and encroachment agreements shall be required by the NCDOT.

Communication Cables / Electrical Services for ITS Devices:

Prior to establishing the location for new meter poles, the Design-Build Team shall coordinate with the local Power Distribution Company concerning accessibility of E/C service and safety in maintenance of the meter.

Prior to installation, the Design-Build Team shall provide plans for review and approval for all service taps that require a parallel installation within the C/A.

Parallel service installation within a C/A shall be buried and located as close to the R/W line as practical. Only due to unusual circumstances will parallel aerial service installations within C/A be allowed. The Design-Build Team shall justify the allowance of parallel aerial service installation and obtain NCDOT approval prior to installation

The Design-Build Team shall be responsible for all coordination activities, including deposit fees, required for the utility company to provide service taps. Prior to the Design-Build Team developing the associated design and / or instructing the utility company to proceed with providing the service taps. The Design-Build Team shall obtain written approval of the service tap locations from the Resident Engineer. The Design-Build Team is responsible for all costs necessary for providing electrical service to the ITS devices.

Adjusting Existing Utilities due to Proposed Traffic Management Systems Fiber Optic Communications Cables:

The Design-Build Team shall be responsible for all costs for coordinating and adjusting any utilities that are in conflict with any proposed ITS or signal communication cables.

Requirements for attachments to existing and / or proposed structures

The Design-Build Team shall avoid attachments to structures where feasible. Attachments shall only be considered when other alternatives are cost prohibitive and / or are not feasible due to environmental or geographical features. Attachments shall be prohibited under the following conditions:

- (A) Unless noted otherwise elsewhere in this RFP, no attachments shall be allowed to a bridge located parallel within the C/A carrying the freeway over streams, other roadways or railroads. (No parallel utility installations within the C/A)
- (B) Unless noted otherwise elsewhere in this RFP, no attachments shall be allowed to cored-slab bridges.
- (C) Unless noted otherwise elsewhere in this RFP, no attachments shall be allowed to curved bridges.

Attachments to structures, if allowed, shall meet the following criteria:

- (A) No attachments shall be allowed below the bottom of the beams and / or girders.
- (B) Drilling of, or attachments to, beams and / or girders shall not be allowed. Attachments shall only be allowed to the bottom of the bridge deck.
- (C) For water and sewer force mains, only restrained joint ductile iron pipe shall be allowed.

- (D) A minimum of 18" of clearance to beams and / or girders shall be maintained if possible.

Documentation of adverse conditions or cost estimates of all feasible alternatives shall be submitted to the NCDOT State Utility Agent, via the State Alternative Delivery Engineer, when seeking approval of a structure attachment. Cost estimates shall consider all costs involved with each alternative and impacts to the utility and the highway project as a whole.

General

The Design-Build Team shall not commence work at points where the highway construction operations are adjacent to utility facilities, until making arrangements with the utility company to protect against damage that might result in expense, loss, disruption of service or other undue inconvenience to the public or utility owner. The Design-Build Team shall be responsible for damage to the existing or relocated utilities resulting from the Team's operations. In the event of interruption of any utilities by the project construction, the Design-Build Team shall promptly notify the proper authority (Utility Company) and cooperate with the authority in the prompt restoration of service.

The Design-Build Team shall accommodate utility adjustments, reconstruction, new installation and routine maintenance work that may be underway or take place during the progress of the contract.

If total property acquisition is unavoidable due to encroachment into wells and / or septic systems, then the Design-Build Team shall investigate and determine if extending water and / or sewer lines to the affected property is cost effective. If the Department concurs with the determination that a utility extension is cost effective, the costs associated with the utility construction shall be addressed in accordance with Article 104-7 of the Standard Specifications.

The Design-Build Team shall make arrangements to relocate water, sewer, or gas line facilities in which the entities are covered under General Statute 136-27.1 or 136-27.2 and/or occupy a compensable interest. Unless noted otherwise elsewhere in this RFP, the non-betterment costs associated with this work shall be borne by the Design-Build Team.

The Design-Build Team shall be required to use the guidelines as set forth in the following:

- (A) *NCDOT Utility Manual - Policies & Procedures for Accommodating Utilities on Highway Rights of Way*
- (B) *Federal Aid Policy Guide - Subchapter G, Part 645, Subparts A & B*
- (C) *Federal Highway Administration's Program Guide, Utility Adjustments & Accommodations on Federal Aid Highway Projects*
- (D) *NCDOT Construction Manual Section 105-8*

- (E) *NCDOT Right of Way Manual* - Chapter 16 Utility Relocations
- (F) *NCDENR Public Water Supply* - Rules governing public water supply
- (G) *NCDENR Division of Water Quality* - Title 15A - Environment and Natural Resources

Agreements

The NCDOT State Utility Agent must execute approved agreements on Design-Build highway projects. The Utility Relocation Agreements (Cost Agreement) and encroachment agreements are available from the NCDOT Utility Coordination Unit. Reference Pages 59 and 60 of the *NCDOT Utility Manual on Policies & Procedures for Accommodating Utilities on Highway Rights of Way* for the different types of encroachment agreements available for use.

The Design-Build Team shall be required to utilize the NCDOT Standard Utility Encroachment Agreements as necessary in relocating utilities. The Encroachment Agreements shall be used under the following conditions:

- (A) If a utility company is not occupying a valid right of way / compensable interest and the proposed relocation will place the relocated utilities within the existing or proposed highway rights of way.
- (B) For **all** new utility installations within the existing or proposed highway rights of way. This includes all water, sewer and gas lines owned by entities covered under *General Statute 136-27.1* and *136-27.2*.
- (C) In either case above, the Design-Build Team shall submit 5 copies of the encroachment plans plus 2 originals and 3 copies of the encroachment agreement to the NCDOT State Utility Agent, via the Transportation Program Management Director, for approval.

NCDOT Information Supplied

- Utility Analysis and Preliminary Routing Plans for R-2413A and R-2413B.
- Duke Progress Energy distribution relocation plans for R-2413A and R-2413B.

ITS SCOPE OF WORK (1-8-14)**GENERAL**

Design, furnish, and install the following ITS devices and communications cable system along the proposed project limits. Interconnect the new fiber optic communications cables with existing fiber optic communications cable installed under R-2413C. The new DMS and CCTV devices will be integrated into the existing computer and network hardware and software at the NCDOT Triad Regional Traffic Management Center (TRTMC) Traffic Management System (TMS) located at 201 South Chimney Rock Road, Greensboro, NC 27409 under a separate contract. Major items of work include, but are not limited to, the following:

- Conduit System (two – 2 inch conduits for communications cable and one – 2 inch conduit for electrical service)
- 72 fiber single-mode fiber optic communications cable
- Drop cable assemblies
- Junction boxes
- Wood Poles
- Splice enclosures
- Eight (8) CCTV cameras
- Five (5) New Dynamic Message Sign (DMS)
- Electrical service equipment
- Local Network Equipment

Furnish and install guardrail to protect the ITS devices as required.

Determine the location of each ITS device, obtain the Engineer's approval of the locations, install and implement test procedures.

Prior to any underground work, locate existing utilities, communications cable, power cable, and adjust work activities to protect these facilities. Immediately cease work and notify the Engineer and the affected owners if damage to existing utilities occurs. Repair damages to existing utilities, communications cable, and / or power cable at no cost to the Department.

Perform all work in accordance with the Dynamic Message Sign Project Special Provision and CCTV Cameras Project Special Provision found elsewhere in this RFP; January 2012 *NCDOT Standard Specifications for Roads and Structures*; and the 2012 *NCDOT Roadway Standard Drawings*.

PROJECT OPERATION REQUIREMENTS**Intermediate Contract Time #8 for Failure to Repair a Damaged Underground Fiber Optic Communications Cable and Restore Communication**

The Design Build Team shall be responsible for repairing all existing underground fiber optic communication cables damaged during construction. The Design-Build Team shall immediately

report damages to the Engineer and TRTMC at (336) 315-7080. The Design-Build Team shall repair all damages within 48 hours at no cost to the Department. The Design-Build Team shall bring all affected fiber optic communication cables back on line within the same 48 hours.

Liquidated Damages for Intermediate Contract Time #8 for failure to repair a damaged fiber optic communication cables and restore communication within 48 hours are \$500.00 per 48-hour period or any portion thereof.

DESIGN REQUIREMENTS

All ITS field devices proposed for this project and all existing ITS devices installed under R-2413C will be integrated at the TRTMC under a separate contract. Design the field-to-center communication network using Gigabit Fiber Optic Ethernet technology. For all equipment not specified herein, including but not limited to encoders and Ethernet equipment, provide product specifications for the Department's review and approval prior to incorporation. Furnish, install, and / or upgrade all field and central equipment, including but not limited to, encoders and switches.

Reuse and maintain the current fiber optic network equipment and configuration.

Splice into the existing fiber optic communications cable installed under TIP R-2413C.

CCTV CAMERAS

Strategically locate eight (8) CCTV cameras at the locations described below so the cameras cumulatively provide full view of the routes indicated. CCTV cameras may be collocated at DMS locations using camera extension poles integrated with the DMS structure, if feasible.

Install one CCTV at each of the two locations where Future I-73 crosses NC 68. Install three additional CCTV cameras along the project limits within R-2413A and B. Install three additional CCTV cameras along the project limits of I-5110.

Determine the exact location of each CCTV camera, obtain Engineer's approval of the locations, and install the cameras. The Engineer may require site surveys, including but not limited to bucket truck surveys, to ensure camera coverage areas are acceptable.

DMS

The Design-Build Team shall locate and install five (5) pedestal mount DMSs along the project limits. Determine the exact location of the DMSs, obtain Engineer's approval of the location, and install the DMSs as described below.

Install two DMSs along the I-5110 project, one in each direction of travel. Install one DMS along NC 68, south of I-5110 in the NB direction of travel. Install two DMSs along the R-2413 projects, one in each direction of travel.

The DMSs to be installed under this project must be selected from the QPL listed elsewhere in this ITS SOW.

CONDUIT

Furnish and install two (2) – 2 inch conduits and all necessary hardware, including tracer wire and delineator markers, by trenching or directional drilling in accordance with Section 1715 and 1733 of the Standard Specifications for installing the fiber optic communications cable. Conduit shall not be placed in the median. For the portion of the conduit necessary outside the project construction limits, the conduit shall be placed fully within NCDOT existing right-of-way

Furnish and install one (1) – 2 inch conduit and all necessary hardware by trenching or directional drilling in accordance with Section 1715 of the Standard Specifications for installing the power service to the ITS devices.

Upon completion of the conduit installation furnish the Engineer with a plan of record drawings showing the horizontal and vertical locations of the installed conduits.

JUNCTION BOXES

Furnish and install junction boxes (pull boxes) with all necessary hardware in accordance with Section 1098-5 of Standard Specifications. Provide oversized junction boxes with minimum inside dimensions of 30”(l) x 15”(w) x 24”(d) inches for installing fiber optic communications cable. Install junction boxes at maximum intervals of fifteen hundred (1500) feet or at locations where underground splicing is necessary.

Furnish and install junction boxes (pull boxes) with all necessary hardware in accordance with Section 1098-5 of Standard Specifications. Provide standard junction boxes with minimum inside dimensions of 16”(l) x 10”(w) x 10”(d) inches for electrical service.

Terminate the fiber optic communications cable in a 36” (l) x 24” (w) x 24” (d) junction box with a splice enclosure capable of accepting a minimum of 6 cables at the east end of the I-5110 project.

WOOD POLES

Furnish and install wood poles with all necessary grounding systems and hardware necessary in accordance with Section 1720 of the Standard Specifications. Provide 60’ wood poles for installing CCTV cameras. Provide wood poles sized as necessary for electrical service installation.

Furnish and install related items of work including but not limited to risers with weatherhead or heat shrink tubing and all necessary hardware in accordance with Section 1720 of the Standard Specifications.

FIBER OPTIC CABLE / DROP CABLE

Furnish and install a 72 single mode fiber-optic communications cable, drop cable assemblies, and all necessary hardware in accordance with the Section 1098-10 Standard Specifications.

Comply with the testing requirements in accordance with the Section 1731 Standard Specifications.

ELECTRICAL SERVICE

Install new electrical service with 200Amps, 240/120 VAC service drops for each ITS device. Furnish and install related items of work, including, but not limited to standard size junction boxes, risers, guy assemblies, and wood poles with all necessary hardware in accordance with Section 1700 of the Standard Specifications.

FIBER-OPTIC SPLICE CENTERS

Furnish and install fiber-optic splice enclosures and all necessary hardware where required to join fiber optic cables. Comply with the Section 1731 Standard Specifications.

Modify existing splice enclosures impacted by the project if necessary. Obtain approval from the Engineer prior to entering any existing splice enclosures.

Within enclosures, provide the necessary number of hinged mountable splice trays to store the number of splices required, plus the capacity to house twelve (12) additional splices. Provide a fiber containment basket for storage of loose buffer tubes that are expressed through the enclosure. Ensure enclosures allow sufficient space to prevent damage of the buffer tubes when coiled.

LOCAL AREA NETWORK

Furnish and install new local area network (LAN) equipment. Furnish equipment that complies with IEEE standard 802. Furnish Ethernet Switches that comply with UL60950 or CSA C22.2 No. 60950 and FCC Part15 Class A for EMI emissions. Furnish all necessary equipment for a complete LAN, including but not limited to field-hardened video encoders; central video decoders; central media converters; field Ethernet switches; and core Ethernet switches.

OTHER CODES AND STANDARDS

All ITS materials shall conform to the latest version of the applicable standards of the National Electrical Code (NEC), National Electric Manufacturer's Association (NEMA), the Underwriters' Laboratories, Inc. (UL), the Electronic Industries Association (EIA), the International Municipal Signal Association (IMSA), and the National Electrical Safety Code (NESC). All materials and workmanship must conform to the requirements of the NESC, standards of the American Society for Testing and Materials (ASTM); American National Standards Institute (ANSI). Comply with all federal laws, state laws, and city codes in accordance with the Standard Specifications.

SUBMITTALS

Submit a 60% setoff preliminary plans, 90% set of preliminary plans and 100% set of project plans including specifications for materials, catalog cuts, and installation and testing requirements for review and approval by the Department. No construction of the ITS devices and relocation of communications cable shall begin until the Department has accepted the 100% plans and specifications. Provide the Department with a minimum of 10 working days for each review.

MATERIALS & CONSTRUCTION

Furnish and install new materials and hardware that meet the requirements of the 2012 *NCDOT Standard Specifications for Roads and Structures* and this Scope of Work.

CCTV CAMERAS

Install each CCTV camera on a 60-foot Class III wood pole. CCTVs may be collocated with the DMSs and installed on the DMS structure with a camera extension pole, if feasible. Install CCTV equipment in a 336S equipment cabinet mounted on the pole. Install the following minimum equipment in each CCTV equipment cabinet:

- Digital Video Encoder
- 4-port Field Ethernet switch with two long haul fiber optic ports for single mode fiber optic cable
- Fiber optic Interconnect Center
- Power equipment including power supplies, circuit breakers, surge protectors, and other related materials.

At each CCTV camera location, install 6-fiber fiber optic drop cable in 2-inch underground conduit. Splice the drop cable into the new or existing 72-fiber fiber optic trunk cable as approved by the Engineer.

Refer to the CCTV Cameras Project Special Provision found elsewhere in this RFP for detailed material specifications and construction requirements.

DYNAMIC MESSAGE SIGNS

Install DMSs on a single steel pedestal type structure with ladders, ladder safety cages, and access platforms leading to the DMS maintenance access door. The DMSs shall be installed 25-foot over the high point of the road as measured from the bottom of the DMS. DMS may be designed for back-to-back installation, if feasible. Install DMS equipment in an approved equipment cabinet mounted on the structure. Install the following minimum equipment in each DMS equipment cabinet:

- DMS controller
- 4-port Field Ethernet switch with two long haul fiber optic ports for single mode fiber optic cable

- Fiber Optic Interconnect Center
- UPS and power equipment including power supplies, circuit breakers, surge protectors, and other related materials.

At each DMS location, install 6-fiber fiber optic drop cable in 2-inch underground conduit. Splice the drop cable into the new or existing 72-fiber fiber optic trunk cable as approved by the Engineer.

Refer to the Dynamic Message Sign Project Special Provision found elsewhere in this RFP for detailed material specifications and construction requirements.

SINGLE MODE FIBER OPTIC COMMUNICATIONS CABLE AND DROP CABLE

Refer to Section 1098-10, 1098-11, 1730, and 1731 of the 2012 NCDOT Standard Specifications for Roads and Structures.

CONDUIT

Furnish and install two (2) – 2-inch inside diameter conduits and all necessary hardware in accordance with the provisions of Sections 1091 and 1715 of the Standard Specifications.

TRACER WIRE

Furnish "green" insulated Number 14 AWG, THWN, stranded, copper wire to serve as a tracer wire in one of the conduits. Install the tracer wire in the same conduit through the entire length of the conduit system. Where tracer wire is spliced, provide waterproof butt splices. Splicing is allowed only in junction boxes.

JUNCTION BOXES

Furnish and install oversized junction boxes (pull boxes) at maximum intervals of fifteen hundred (1500) feet and as necessary for future device installation and directional drilling conduit segments in accordance with Sections 1098-5 and 1716 of the Standard Specifications.

Furnish and install standard size junction boxes at locations requiring electrical service in accordance with Sections 198-5 and 1700 of the Standard Specifications.

Provide junction box covers with standard "NCDOT Fiber-Optic Cable" logo, pull slots and stainless steel pins.

Comply with Article 1411-3 of the Standard Specifications, except as follows:

Install junction boxes flush with finished grade.

Do not install sealant compound between junction boxes and covers.

Install junction boxes where underground splicing of cable is necessary and where transitioning from below ground to above ground installation or vice-versa.

DELINEATOR MARKERS

Furnish and install delineator markers with all necessary hardware in accordance with the provisions of Section 1098-13 and 1733 of the Standard Specifications.

Place delineator marker at every splice and junction box location.

Provide text, including the division contact number that is hot stamped in black on a yellow background material that will not fade or deteriorate over time. Provide delineator markers with a nominal message height of 15 inches and that contain the following text visible from all directions approaching the assembly:

**WARNING
NCDOT FIBER OPTIC CABLE
BEFORE EXCAVATING OR
IN AN EMERGENCY
CALL: (336) 315-7080**

Install delineator markers at fifteen hundred (1500) feet intervals. Install delineator markers using a method that securely anchors the delineator marker in the ground to prohibit twisting and easy removal.

QUALIFIED PRODUCTS LIST

Submit a listing of items including Dynamic Message Signs on the NCDOT 2012 Qualified Products List (QPL) to receive approval for use on the project. Catalog cuts will not be required for items on the QPL. The QPL web site is:

<https://connect.ncdot.gov/resources/safety/Pages/default.aspx>

MAINTENANCE AND REPAIR REQUIREMENTS

Maintain and repair the ITS devices within the project scope until the final acceptance of the project by the NCDOT. After the acceptance of the project, the Design-Build Team shall be responsible for repairing the system due to faulty materials or workmanship in accordance with the Project Special Provision "Twelve-month Guarantee" or longer warranty period offered by the Design-Build Team.

PLAN OF RECORD DOCUMENTATION

Prepare and submit to the Department Plan of Record (POR) documentation that depicts the conduit and ITS device locations. Submit final POR documentation in electronic and hard copy format for approval by the Department. Provide electronic plans in MicroStation (latest release in use by the Department) format on CD. Submit hard copy documentation on 22X34 inch plan

sheets. POR documentation shall include the final location and depth of conduits, wiring external to the cabinets, locations of splice closures, junction box locations, and SMFO cable terminations. Include in the POR documentation real world coordinates for all ITS devices, splice enclosures, junction boxes, and equipment cabinets installed or utilized under this project. Provide the coordinates in feet units using the North Carolina State Plane coordinate system (1983 North American Datum also known as NAD '83). Furnish coordinates that do not deviate more than 1.7 feet in the horizontal plane and 3.3 feet in the vertical plane. Global positioning system (GPS) equipment able to obtain the coordinate data within these tolerances may be used.

LOCAL AREA NETWORK

Furnish and install media access control (MAC) address for all equipment utilized as part of this project. Affix MAC address labels to each device utilized. Furnish IP address for all equipment utilized as part of this project. Affix final IP address labels to each device utilized. Fully integrate LAN equipment providing local device failover and fault tolerance. Fully integrate LAN equipment to provide virus protection, user authentication, and security functions to prevent unauthorized user and data from entering the LAN.

Develop a Requirements Definition Document that will form as the basis for the overall network architecture and design for the Department review and approval.

FUTURE INTEGRATION

Provide all necessary central equipment, including but not limited to, digital video decoders, central Ethernet switch with appropriate number of copper and fiber optic ports, fiber optic and copper patch cords, **and all other material required** for the successful future integration of new devices.

TESTING

Develop unit and system test plans and procedures for each ITS device and component and submit to the Engineer for review and approval. This includes but is not limited to CCTVs, DMSs, fiber optic communications cable and central equipment.

Upon completion of the system installation, conduct unit and system tests according to approved test plans and procedures. Provide all necessary test equipment.

In case of failures and substandard performance, the Design Build Team shall identify the cause, repair or replace the faulty parts and components and repeat the test. If the problem persists, the entire unit causing the problem shall be replaced prior to retest.

After successful completion of all units and system test, submit the test reports along with the record of repairs and part replacements to the Engineer.

TRAFFIC SIGNALS SCOPE OF WORK (10-28-13)**I. GENERAL**

The Design-Build Team shall design and prepare plans for the traffic signal installations. This work shall include, but not be limited to, the preparation of Traffic Signal Plans, Metal Pole Loading Diagrams, Electrical and Programming Details, Utility Make-Ready Plans, Communications Cable & Conduit Routing Plans, maintaining an existing wireless communications network and Project Special Provisions.

The Design-Build Team shall select a Private Engineering Firm (PEF) that has experience designing Traffic Signal Plans for NCDOT on comparable projects. The Technical Proposal shall list projects, including description and similarity to the subject project, on which the PEF has developed Traffic Signal Plans, as well as traffic signal experience of the individual(s) that will develop the Traffic Signal Plans. The Design-Build Team shall perform all work in accordance with the 2012 NCDOT *Standard Specifications for Roads and Structures* and NCDOT *Standard Roadway Drawings*.

A pre-design meeting shall take place between the NCDOT ITS & Signals Unit, the NCDOT Division 7 Traffic Engineer, the Design-Build Team, the City of Greensboro Department of Transportation and any other pertinent NCDOT personnel before signal designs begin. ITS & Signal Plan submittals shall only be reviewed and accepted by the Department after this pre-design meeting. The Design-Build Team shall concurrently provide plan submittals to NCDOT and the City of Greensboro Department of Transportation. However, the Department will ultimately be responsible for the traffic signal submittal reviews and comments. All Traffic Signal Plans shall be accepted by the ITS & Signals Unit prior to beginning traffic signal construction or plan implementation.

The Design-Build Team shall coordinate and implement all signal designs at the appropriate time as directed by the Engineer. The Design-Build Team shall maintain, monitor and adjust the traffic signals as needed throughout the project. The Design-Build Team shall be responsible for the design and implementation of all temporary traffic signal designs needed to maintain traffic during construction. If necessary, Temporary Traffic Signal designs and implementation, shall include, but not be limited to, new local controller, signal timing, cables, poles, signal span, controllers, cabinets, and / or signal heads. **The Design-Build Team shall maintain full actuation of the traffic signals on this project during the life of the project.**

The Design-Build Team shall install new or upgrade existing traffic signals, with all new equipment, at the intersections noted below. The Design-Build Team shall connect these traffic signals, via a fiber optic cable link, to the Greensboro Signal System or a standalone closed loop signal system as indicated below.

The Design-Build Team shall install system timing plans for signals interconnected in the closed loop system. All signal system timing plans shall be reviewed and accepted by the Department prior to implementation. Prior to placing traffic in a new pattern, all traffic signals shall be installed and operational, including but not limited to the aforementioned signal system timing plans and interconnection to the appropriate Signal System.

The Design-Build Team shall be responsible for providing a safe and economical design for the public. The Design-Build Team shall prepare all designs in accordance with the current ITS & Signals Unit design standards, including but not limited to, the version of the following documents that are effective on the Technical Proposal submittal date:

- NCDOT 2012 *Standard Specifications for Roads and Structures*
- NCDOT *Standard Roadway Drawings*
- ITS & Signals Unit Project Special Provisions
- ITS & Signals Unit Design Manual
- *Manual on Uniform Traffic Control Devices (MUTCD)*
- *North Carolina Supplement to the Manual on Uniform Traffic Control Devices (NCMUTCD)*
- *Guidelines for Preparation of Traffic Signal & Intelligent Transportation System Plans on Design-Build Projects*

Links to additional ITS & Signals Unit design standards and aides are available on the website noted below:

<https://connect.ncdot.gov/resources/safety/Pages/default.aspx>

II. TRAFFIC SIGNALS

The NCDOT ITS & Signals Unit will assign Signal Inventory Numbers (SIN) for each new permanent signalized location. Once all the new permanent traffic signal locations have been finalized and accepted by the Department, the Design-Build Team shall submit a written request for the SINS to the NCDOT ITS & Signals Unit. At a minimum, this request shall list each signal location that requires a SIN and include the following:

- County
- Nearest Municipality
- Names of all intersecting roads that will be under signal control, including state route numbers (Interstate, US, NC or SR) and common street names
- The dominant through movement

NC 150 - 2 New Signals		
Signal Inventory Number	Intersection Description	Work Requirements
TBD	NC 150 at NC 68 Connector Northbound Ramps	<p>The Design-Build Team shall design and install a new, fully actuated traffic signal with a 2070 Controller operating OASIS software in a 170 cabinet, including base adapters / extenders, at these locations.</p> <p>The Design-Build Team shall incorporate Flashing Yellow Arrow signal heads at all protected / permissive left turns and U-Turns.</p> <p>The Design-Build Team shall interconnect these signals into the new “NC 150 Closed Loop Signal System”.</p>
TBD	NC 150 at NC 68 Connector Southbound Ramps	<p>Unless NCDOT provides written approval otherwise, all final signal designs shall utilize inductive loop detection.</p> <p>The Design-Build Team shall use wood poles as the signal supports.</p> <p>Prior to final design and installation, the Design-Build Team shall coordinate all signal phasing recommendations with the Division Traffic Engineer, the Regional Traffic Engineer and the ITS & Signals Unit.</p> <p>Upon placing each traffic signal in operation, including all required temporary traffic signals, the Design-Build Team shall install the required fiber optic communications system as described in Section III.</p> <p>The Design-Build Team shall install a phone-drop at the master location.</p>

NC 68 - 3 New Signals		
Signal Inventory Number	Intersection Description	Work Requirements
TBD	NC 68 at Ramp/Loop D	<p>The Design-Build Team shall design and install a new, fully actuated traffic signal with a 2070 Controller operating Naztec software, in a 170 cabinet, including base adapters / extenders, at these locations.</p> <p>The Design-Build Team shall incorporate Flashing Yellow Arrow signal heads at all protected / permissive left turns and U-Turns.</p> <p>The Design-Build Team shall use NCDOT standard metal strain poles as the signal supports.</p> <p>Unless NCDOT provides written approval otherwise, all final signal designs shall utilize inductive loop detection.</p>
TBD	NC 68 at Service Road and Ramp/Loop A	<p>Vehicle detection, as noted above shall be maintained for all movements throughout construction.</p> <p>Prior to final design and installation, the Design-Build Team shall coordinate all signal phasing recommendations with the Division Traffic Engineer, the Regional Traffic Engineer, the ITS & Signals Unit and the City of Greensboro Department of Transportation.</p>
TBD	NC 68 at SR 2016 (Leabourne Road)	<p>The Design-Build Team shall interconnect these signals in the Greensboro Signal System utilizing the following:</p> <ul style="list-style-type: none"> • Naztec controllers with licenses • 2070 signal monitors with IP port • RuggedCom 6 port Ethernet network switch in each cabinet. <p>Upon placing each traffic signal in operation, including all required temporary traffic signals, the Design-Build Team shall install the required fiber optic communications system as described in Section III.</p>

NC 68 – 3 Signal Upgrades		
Signal Inventory Number	Intersection Description	Work Requirements
07-0968	NC 68 at SR 2133 (Pleasant Ridge Road)	<p>The Design-Build Team shall modify / upgrade these existing traffic signals to match all temporary construction phasing and the proposed final traffic pattern.</p> <p>The Design-Build Team shall provide all new equipment for fully actuated traffic signals, including but not limited to installing a 2070 Controller operating Naztec software, in a 170 cabinet, including base adapters / extenders, at these locations.</p> <p>The Design-Build Team shall incorporate Flashing Yellow Arrow signal heads at all protected / permissive left turns and U-Turns.</p> <p>The Design-Build Team shall use NCDOT standard metal strain poles as the signal supports.</p> <p>Unless NCDOT provides written approval otherwise, all final signal designs shall utilize inductive loop detection.</p>
07-1459	NC 68 at SR 2011 (Edgefield Road)	<p>Vehicle detection, as noted above shall be maintained for all movements throughout construction.</p> <p>Prior to final design and installation, the Design-Build Team shall coordinate all signal phasing recommendations with the Division Traffic Engineer, the Regional Traffic Engineer, the ITS & Signals Unit and the City of Greensboro Department of Transportation.</p>
07-2001	SR 2085/SR 4464 (Bryan Boulevard) at SR 2084 (Burgess Road) / SR 4156 (North Regional Road)	<p>The Design-Build Team shall interconnect these signals in the Greensboro Signal System utilizing the following:</p> <ul style="list-style-type: none"> • Naztec controllers with licenses • 2070 signal monitors with IP port • RuggedCom 6 port Ethernet network switch in each cabinet. <p>Upon placing each traffic signal in operation, including all required temporary traffic signals, the Design-Build Team shall install the required fiber optic communications system as described in Section III.</p> <p>The Design-Build Team shall return the traffic signal controllers, cabinets, including contents, and signal heads to the Division 7 Traffic Office. The Design-Build Team shall dispose of and / or retain ownership of all other equipment.</p>

III. SIGNAL COMMUNICATIONS

The Design-Build Team shall coordinate their design with the City of Greensboro Department of Transportation, the ITS & Signals Unit and the Division 7 Traffic Engineer.

A. NC 68 Greensboro System

In order for the five (5) NC 68 signals listed in Section II to be interconnected into the Greensboro Signal System, the Design-Build Team shall design and install a new communications cable and conduit routing network among the following signals:

- 1) 07-0968 = NC 68 @ Pleasant Ridge Rd.
- 2) 07-1459 = NC 68 @ Edgefield Rd.
- 3) 07-new = NC 68 @ Ramp Loop D
- 4) 07-new = NC 68 @ Service Rd. & Ramp Loop A
- 5) 07-new = NC 68 @ Leabourne Rd.

The communications cable and conduit network shall consist of a minimum of two 2-inch conduits. The Design-Build Team shall install a 24 fiber optic cable in one of these two conduits.

In addition to installing a fiber network among the above listed signals, the Design Build Team shall continue the communications cable and conduit network to connect with the City of Greensboro's fiber ending in the vicinity of NC 68 @ Joseph M. Bryan Boulevard. This fiber point connects to a wireless communications network which provides communications to signals 07-0968, 07-1459 (listed above) plus two additional signals listed below:

- 1) 07-2001 = Joseph M. Bryan Blvd. @ Burgess Road/North Regional Road
- 2) 07-1029 = Regional Road @ Bentley Road

The wireless link originating in the vicinity of NC 68 @ Joseph M. Bryan Blvd to 07-2001 and 07-1029 is to remain operational throughout the project. The existing ENCOM Wireless equipment may be reused.

The Design-Build Team shall furnish new "field hardened 6 Port Ethernet Edge Switch" equipment that is compatible with the Greensboro Signal System at all signals interconnected via the fiber optic cable.

To maintain operation, the Design-Build Team shall relocate, repair and / or reinstall all existing equipment being utilized by the Greensboro Signal System (Fiber Optic Splice Cabinets, Ethernet Edge Switches, ENCOM wireless Devices, etc.) impacted by construction.

B. NC 150 Closed Loop System

The Design-Build Team shall interconnect the two (2) new NC 150 at NC 68 signals listed in Section II with fiber optic cable (12 fiber) in a standalone closed loop signal system with a phone drop at the master cabinet.

C. Communications Cable & Conduit Routing Plans, and Project Special Provisions

Prior to construction, the Design-Build Team shall provide a detailed set of Communications Plans and Project Special Provisions for the Department's and the City of Greensboro's review and acceptance. No construction related to the installation of the communications system shall begin until NCDOT has accepted the RFC Communications Plans and Project Special Provisions.

The Communications Plans and Project Special Provisions shall consist of the three major items listed below:

- Communications Plans including Splice Plans
- Project Special Provisions
- Catalog Cut Sheets

D. Utility Make-Ready Plans

In conjunction with the development of the Communications Cable and Conduit Routing Plans and Traffic Signal Plans, the Design-Build Team shall also develop a set of Utility Make-Ready Plans if applicable.

The Design-Build Team shall transfer / install all traffic signal equipment, communications cables and conduit systems in such a manner that avoids conflicts with other utilities. All aerial communications cable installations shall be installed in accordance with the National Electrical Safety Code. The Design-Build team is responsible for coordinating all Utility Make Ready Work with the proper utility representatives.

RIGHT OF WAY SCOPE OF WORK (12-20-13)

**** NOTE ** Prior to negotiating property acquisition with property owners, the Design-Build Team shall meet with the appropriate NCDOT Location and Surveys, Right of Way and Transportation Program Management personnel.**

R-2413A & B

As shown on the R-2413A and R-2413B Right of Way Plans provided by the Department, the NCDOT anticipates acquiring all right of way, easements and control of access by the dates noted below. In the event additional right of way, easements and / or control of access are needed to construct the project beyond that which is shown on the aforementioned Right of Way Plans, the Design-Build Team shall acquire the additional right of way, easement and / or control of access in accordance with the provisions of this scope of work.

The cost of the right of way, easement and control of access, as shown on the R-2413A and R-2413B Right of Way Plans provided by the Department, will be borne by the Department. The cost of both the acquisition services and the actual cost of any additional right of way, easement and / or control of access as required by the Design-Build Team's design or construction methods (including all erosion control measures), beyond that shown on the aforementioned Right of Way Plans, shall be the responsibility of the Design-Build Team. The following exception applies to this paragraph:

If the Design-Build Team demonstrates to the Department's satisfaction that the project cannot be constructed, or utilities relocated / constructed, within the right of way, easements and / or control of access as shown on the R-2413A and R-2413B Right of Way Plans provided by the Department, the Department will bear the cost for the portion of the additional right of way, easement and / or control of access that is satisfactorily demonstrated by the Design-Build Team as needed to construct the facility. All acquisition services costs will remain the responsibility of the Design-Build Team.

Excluding the R-2413A parcels noted below, the Department has acquired the right of way, easement and control of access for all the R-2413A parcels:

Parcel Nos. 22, 25, 26, 28, 28A and 74

The Department anticipates completing the R-2413A right of way, easement and control of access acquisition for the following parcels by March 1, 2014:

Parcel Nos. 28, 28A and 74

For the parcels noted below, the Department has acquired a right of entry which will expire two years after the final project completion. The aforementioned right of entry allows the Design-Build Team to access only the proposed right of way shown on the R/W Acquisition Exhibit for the Greenlea 68 Land, LLC property developed by CPT Engineering and Surveying, Inc. dated September 18, 2012 and revised November 4, 2013, December 9, 2013 and December 19, 2013 (Electronic File acad-828-07_BOUNDARY_SOUTH_02—15-13_12-19-13_EXHIBIT 823-07_BOUNDARY_SOUTH_S.Johnson_12-19-13.pdf provided by the Department) The Department will complete the right of way, easement and control of access acquisition for these

parcels within sixty days of receiving written notification that the right of way revisions developed by the Design-Build Team for the Service Road -Y1C- design revisions have been approved. (Reference the Roadway Scope of Work found elsewhere in this RFP)

Parcel Nos. 22, 25, 26

Excluding the R-2413B parcels noted below, the Department has acquired the right of way, easement and control of access for all the R-2413B parcels. The Department anticipates completing the R-2413B right of way, easement and control of access acquisition for the following parcels by April 15, 2014.

Parcel Nos. 7, 8, 9, 10, 11Z, 12, 15-19, 21, 22, 24, 24A, 26

I-5110

Through the Advance Acquisition Process, the Department has acquired Parcel No. 950 and anticipates acquiring the following I-5110 parcels, as total takes, by project Award; or will file condemnation claims upon project Award, if necessary:

Parcel Nos. 970 and 975

In accordance with the provisions of this Scope of Work, the Design-Build Team shall acquire right of way, easement and control of access for all other I-5110 parcels.

R-2413A & B and I-5110

For all right of way, easements and / or control of access acquisitions required by the Design-Build Team's design, including all design revisions required by this RFP, and / or construction methods, the Design-Build Team shall carry out the following responsibilities:

- The Design-Build Team shall employ qualified, competent personnel who are currently **approved by the NCDOT Right of Way Branch**, to provide all services necessary to perform all appraisal (except appraisal reviews and updated appraisals required solely for condemned parcels), negotiation and relocation services required for all right of way, easements and control of access, including but not limited to permanent utility easements, necessary for completion of the project in accordance with G.S. 136-28.1 of the General Statutes of North Carolina, as amended, and in accordance with the requirements set forth in the *Uniform Appraisal Standards and General Legal Principles for Highway Right of Way*, the North Carolina Department of Transportation's *Right of Way Manual*, the North Carolina Department of Transportation's *Rules and Regulations for the Use of Right of Way Consultants*, the *Code of Federal Regulations*, and Chapter 133 of the *General Statutes of North Carolina* from Section 133-5 through 133-18, hereby incorporated by reference, including the Uniform Relocation Assistance and Real Property Acquisition Policies Act of 1970, as amended. For a list of firms currently approved by the Department, the Design-Build Team should contract Mr. Neal Srickland, in the NCDOT Right of Way Branch, at 919-707-4364. The Design-Build Team shall perform the services as set forth herein and furnish and deliver to the Department reports accompanied by all documents necessary for the settlement of claims and the recordation of deeds, or necessary for condemnation proceedings covering said properties. The Design-Build Team, acting as an agent on behalf

- of the State of North Carolina shall provide right of way acquisition services for all additional right of way, easements and control of access not acquired by the Department.

Acquisition services required outside of the project construction limits due solely to a rise in the floodplain water elevation on insurable structures will be considered extra work and paid for in accordance with Article 104-7 of the 2012 *Standard Specifications for Roads and Structures*.

- Unless noted otherwise elsewhere in this RFP, with respect to the payments, costs and fees associated with the acquisition of right of way, easements and / or control of access, the Department will be responsible for only direct payments to property owners for negotiated settlements, recording fees, any relocation benefits, and deposits and fees involved in the filing of condemnation claims. The Department will assume responsibility for all costs associated with the litigation of condemnation claims, including testimony by the appraiser(s). The Design-Build Team shall be responsible for all other acquisition services related to payments, costs and fees, including but not limited to attorney fees required for all non-condemnation acquisitions.
- A Department representative will be available to provide technical guidance on right of way acquisition procedures and to make timely decisions on approving relocation benefits and approving administrative adjustment settlements on behalf of the Department over and above the authority granted to the Department Right of Way Consultant Project Managers.
- The Design-Build Team shall submit a right of way project tracking report and right of way quality control plan to the Department. The Department standard forms and documents shall be used to the extent possible.
- The Design-Build Team shall provide a current title certificate for each parcel as of the date of closing or the date of filing of condemnation, unless required otherwise in the Department's Right of Way Manual.
- The Design-Build Team shall prepare all Final Condemnation Reports. For all plan revisions on condemned parcels that modify the area acquired, modify the control of access and / or impact the appraised value, the Design-Build Team shall be responsible for the following:
 - The Design-Build Team shall notify the Division Right of Way Agent, the Area Negotiator, Area Appraiser and the Attorney General in writing that revisions have been made that impact a condemned parcel, and provide updated plan sheets and revised area takes.
 - The Design-Build Team shall consult with the Attorney General and the Area Appraiser to determine the status of the negotiations and appraisal(s).
 - If settlement is not imminent, the Design-Build Team shall provide an updated Summary Sheet to the Area Appraiser for the Department's use in obtaining an updated appraisal(s).

- Upon receipt of the approved updated appraisal(s), the Design-Build Team shall develop a revised written offer. If settlement is not reached, the Design-Build Team shall submit an updated Final Condemnation Report. If settlement is reached, the Design-Build Team shall notify the Attorney General and Area Appraiser in writing and submit an updated Final Condemnation Report with all necessary documentation.
- The Department will be responsible for payment for the additional deposit to the Attorney General's Office and the Attorney General will prepare and file an Amendment to the Declaration of Taking.
- The following shall be required:
 - Unless otherwise approved by the Engineer in writing, the Design-Build Team shall provide right of way and easement descriptions in metes and bounds format (bearings and distances). The Design-Build Team shall provide exhibits, diagrams and / or other information required to verify the aforementioned descriptions.
 - In accordance with the NCDOT Right of Way Manual, the Design-Build Team may prepare red-line adjustments for parcels that are not condemned. The Department must approve a red-line adjustment in writing prior to the Design-Build Team making an offer based on the red-line adjustment.
 - The Design-Build Team shall prepare, execute and record documents conveying title to acquired properties to the Department with the Register of Deeds
 - The Design-Build Team shall deliver all executed and recorded deeds and easements to the Department.
 - For all property purchased in conjunction with the project, title shall be acquired in fee simple or easement and shall be conveyed to "The North Carolina Department of Transportation", free and clear of all liens and encumbrances except permitted encumbrances.
- It is understood and agreed by and between the parties hereto that all reports, surveys, studies, specifications, memoranda, estimates, etc., secured by and for the Design-Build Team shall become and remain the sole property of the Department upon termination or completion of the work, and the Department shall have the right to use same for any public purpose without compensation to the Design-Build Team.
- The Design-Build Team shall prepare appraisals in accordance with the Department's *Uniform Appraisal Standards and General Legal Principles for Highway Right of Way Acquisitions*. The Design-Build Team's appraiser shall be on the Department's approved state certified appraiser list. The Design-Build Team may request its state certified appraiser be added to the approved state certified appraiser list, subject to approval by the Department's State Appraiser.

- The Design-Build Team shall provide two appraisals for all appraisals over \$1,000,000.00.
- The NCDOT, or its agent, will provide appraisal reviews complying with the Department's *Uniform Appraisal Standards and General Legal Principles for Highway Right of Way Acquisitions*. The reviewer will ensure that the appraisal meets the Department's guidelines and requirements, conforms to acceptable appraisal standards and techniques, does not include any non-compensible items or exclude any compensible items and that the value conclusions are reasonable and based on facts presented in the appraisal. The reviewer has the authority to approve, adjust, request additional data or corrections, or not to recommend and request another appraisal. Within ten business days from the date of receipt, all appraisals will be reviewed by NCDOT Review Appraisers or Review Appraisers under contract to the corresponding NCDOT Area Appraisal Office. The NCDOT will sign as approving any and all appraisals to be used in acquisition.
- The Design-Build Team shall provide a right of way certification prior to entering the property.
- The Design-Build Team shall prepare Value Findings and / or Narrative Appraisals for all right of way and easement acquisitions. Claim Reports will not be allowed for any acquisition.

EROSION AND SEDIMENTATION CONTROL SCOPE OF WORK (12-16-13)

The NCDOT Roadside Environmental Unit shall review and accept all Erosion and Sedimentation Control Plans. Clearing & Grubbing and Final Grade Release for Construction (RFC) Erosion Control Plans shall be submitted to all NCDOT Personnel listed in the Design-Build Submittal Guidelines before **any** land disturbing activities, including clearing and grubbing, can commence. If the Design-Build Team chooses to perform the work in discrete sections, then a complete set of Clearing & Grubbing and Final Grade RFC Erosion Control Plans shall be submitted, accepted, and distributed as noted above prior to land disturbing activities, including clearing and grubbing, commencing in that section. No land disturbing activities, including clearing and grubbing, shall occur in any location that does not have accepted Clearing & Grubbing and Final Grade RFC Erosion Control Plans. Refer to the most recent version of the *NC DENR - Erosion and Sediment Control Planning and Design Manual* for erosion control design guidelines not addressed in this Scope of Work.

To ensure adherence with the August 3, 2011 NCG-010000 General Construction Permit, issued by the North Carolina Department of Environment and Natural Resources, Division of Water Quality, the Design-Build Team shall formally submit a project-wide Vegetation Management Procedure for the Department's review and acceptance prior to any land disturbing activities. After this initial review, the Design-Build Team shall concurrently provide the Resident Engineer and Roadside Environmental Field Operations Engineer updated versions of the Vegetation Management Procedure on a monthly basis. These updated versions will not require formal submittal to the Transportation Program Management Office, but will be subject to review comments by the aforementioned field personnel. All versions of the Vegetation Management Procedure shall include, but not be limited to, provisions for the early establishment of grasses / vegetation, and procedure and schedule details for fertilizer topdressing, supplemental seeding, mowing and repair seeding. The Vegetation Management Procedure shall be closely coordinated with the grading and hauling operations. The Design-Build Team shall provide a narrative overview of the Vegetation Management Procedure in the Technical Proposal.

From the beginning through the end of construction, the Design-Build Team shall maintain comprehensive "red-line" As-Built Plans that detail when and where permanent / temporary / repair seeding and topdressing have been performed.

Erosion and Sedimentation Control Plans shall at a minimum address the following:

I. Complete Set of Plans

A. Clearing and Grubbing Phase

1. Use correct NCDOT symbology.
2. Protect existing drainage structure inlets with Rock Inlet Sediment Trap Type 'A' (RIST-A), Rock Inlet Sediment Trap Type 'C' (RIST-C), Rock Pipe Inlet Sediment Trap Type 'A' (PIST-A), etc.
3. Utilize adequate perimeter controls (temporary silt ditches (TSD), temporary silt fence (TSF), etc.).
4. Place Special Sediment Control Fence at toe of bridge approach fills along stream.

5. Utilize skimmer basins and rock measures with sediment control stone (Temporary Rock Sediment Dam Type 'B' (TRSD-B), Temporary Rock Silt Check Type 'A' (TRSC-A), etc.) at drainage outlets.
6. Take into account topography and show existing contour lines on Clearing & Grubbing Plans only.
7. Show 50-foot Environmentally Sensitive Area (ESA) around all jurisdictional streams on Clearing & Grubbing Plans only.
8. For R-2413A & R-2413B, Jordan Lake Riparian Buffer rules only apply for modifications to the USACE 404 Permit and the NCDWQ Section 401 Certification. Reference the Environmental Permits Scope of Work elsewhere in this RFP.
9. Utilize Temporary Rock Silt Checks Type 'B' (TRSC-B) to reduce velocity in existing ditches with spacing of 250 feet divided by percentage of ditch grade. Also utilize TRSC-B's in proposed TSD's and temporary diversions (TD).
10. Protect existing streams; do not place erosion control devices in live streams unless permitted by the Division of Water Quality 401 Certification and the Army Corps of Engineers 404 Permits.
11. Provide adequate silt storage for 3600 cubic feet per disturbed acre and sediment basins shall be sized with surface area equal to 435 square feet per cubic foot per second (cfs) of the peak inflow rate, Q25, using 25-year peak rainfall data (*NCDENR - Erosion and Sediment Control Planning and Design Manual* or NOAA's National Weather Service web site <http://dipper.nws.noaa.gov/hdsc/pfds/> for partial duration (ARI) time series type). A Sediment Basin Designer Spreadsheet will be provided by the NCDOT Roadside Environmental Unit (REU) upon request.
12. Skimmer Basins shall provide adequate silt storage for 1800 cubic feet per disturbed acre with surface area equal to 325 square feet per cubic foot per second (cfs) of the peak inflow rate, Q25, using the 25-year peak rainfall data (*NCDENR - Erosion and Sediment Control Planning and Design Manual* or NOAA's National Weather Service web site <http://dipper.nws.noaa.gov/hdsc/pfds/> for partial duration (ARI) time series type). A Skimmer Basin Designer Spreadsheet will be provided by the NCDOT Roadside Environmental Unit (REU) upon request.
13. The minimum and maximum length to width ratio of all Sediment Basins shall be 2:1 and 6:1, respectively.
14. Coir Fiber Baffles shall be installed in all silt basins and sediment dams at drainage outlets. For silt basins with a 20-foot or longer length, three Coir Fiber Baffles shall be installed with a spacing of 1/4 the basin length. For silt basins with a length less than 20 feet, a minimum of two Coir Fiber Baffles shall be installed, with a spacing of 1/3 the basin length. The Design-Build Team will not be required to show the individual baffles on the Erosion Control Plans, but shall be required to incorporate the Coir Fiber Baffle Detail on the Erosion Control Plans.
15. Include any culvert and / or pipe construction sequence plan sheets in the Clearing & Grubbing Plans; all pipes 48 inches or larger, or any combination of pipes that total 48 inches or more require a construction sequence. Prior to installation of pipes smaller than 48 inches in jurisdictional areas, the Design Build Team shall submit a phasing plan for managing the watercourse to the Resident Engineer for review and

- acceptance. The phasing plan shall be in accordance with the Best Management Practices for Construction and Maintenance Activities.
16. Incorporate temporary sediment basins into permanent stormwater devices.
 17. Utilize Coir Fiber Wattles with Polyacrylamide (PAM) and / or TRSC-As with Matting and PAM in temporary and permanent, existing and proposed ditches at a spacing of 50 feet in areas where sediment basins are not feasible at drainage outlets and in areas where sediment basins at drainage outlets with sediment traps (i.e. PIST-A, RIST-A, etc.), cannot be properly sized to surface area and / or sediment storage requirements due to safety concerns, right of way restrictions, utility conflicts, or other construction limitations approved by the Roadside Environmental Unit.
 18. Place a device utilizing PAM at all sediment basin inlets.
 19. Do not place erosion control devices that require excavation (i.e. basins, silt ditches, etc.) in wetlands or buffer zones.
 20. Within the entire project limits, provide disturbed and undisturbed drainage areas in MicroStation Format.
 21. For all drainage outlets where the runoff cannot be treated with a sediment basin and / or the sediment basin cannot be constructed to the required sediment storage or surface area requirements, provide a written explanation.
 22. To the maximum extent practicable, Sediment Basins shall be placed on the perimeter of the project limits and outside of fill slopes.

B. Final Grade Phase

1. Use correct NCDOT symbology.
2. Protect existing and proposed drainage structure inlets with RIST-A, RIST-C, PIST-A, etc.
3. Utilize adequate perimeter controls (TSD, TSF, etc.).
4. Place Special Sediment Control Fence at toe of bridge approach fills along streams.
5. Utilize TRSC-B's to reduce velocity in existing and proposed ditches with spacing of 250 feet divided by percentage of ditch grade. Also utilize TRSC-B's in proposed TSD's and TD's.
6. Utilize temporary slope drains and earth berms at top of fill slopes 8 feet or higher and a fill slope grade of 3:1 or steeper, or where there are superelevations above 0.04 and fills are greater than 5 feet. Maximum slope drain spacing shall be 200 feet.
7. Utilize rock energy dissipater and / or silt basin at outlet of slope drain.
8. Devices at all drainage turnouts shall utilize infiltration, skimmer, or sediment control stone (TRSD-B, TRSC-A, etc.) and a spillway with an adequately designed base length to distribute outflow.
9. Provide adequate silt storage for 3600 cubic feet per disturbed acre and sediment basins shall be sized with surface area equal to 435 square feet per cubic foot per second (cfs) of the peak inflow rate, Q25, using 25-year peak rainfall data (*NC DENR - Erosion and Sediment Control Planning and Design Manual* or NOAA's National Weather Service web site <http://dipper.nws.noaa.gov/hdsc/pfds/> for partial duration (ARI) time series type). A Sediment Basin Designer Spreadsheet will be provided by NCDOT REU upon request.

10. Skimmer Basins shall provide adequate silt storage for 1800 cubic feet per disturbed acre with surface area equal to 325 square feet per cubic foot per second (cfs) of the peak inflow rate, Q25, using the 25-year peak rainfall data (*NCDENR - Erosion and Sediment Control Planning and Design Manual* or NOAA's National Weather Service web site <http://dipper.nws.noaa.gov/hdsc/pfds/> for partial duration (ARI) time series type). A Skimmer Basin Designer Spreadsheet will be provided by the NCDOT Roadside Environmental Unit (REU) upon request.
11. Provide matting for erosion control in all ditch lines, including but not limited to temporary ditch lines (TDs) utilized to divert offsite runoff around construction areas, where the velocity is greater than 2.0 feet / sec, and the shear stress is 1.55 psf or less. For ditch lines with a shear stress above 1.55 psf, Permanent Soil Reinforcement Mat or Rip Rap shall be utilized.
12. Unless otherwise approved by the Roadside Environmental Field Operations Engineer, provide matting for erosion control on all slopes (cut and fill) that are steeper than 4:1 and a height of eight feet or greater.
13. Along all slopes (cut and fill) that are 30 feet or higher, place parallel rows of 12-inch Excelsior Wattles at a spacing height of 15 feet.
14. The minimum and maximum length to width ratio of all Sediment Basins shall be 2:1 and 6:1, respectively.
15. Coir Fiber Baffles shall be installed in all silt basins and sediment dams at drainage outlets. For silt basins with a 20-foot or longer length, three Coir Fiber Baffles shall be installed with a spacing of 1/4 the basin length. For silt basins with a length less than 20 feet, a minimum of two Coir Fiber Baffles shall be installed, with a spacing of 1/3 the basin length. The Design-Build Team will not be required to show the individual baffles on the Erosion Control Plans, but shall be required to incorporate the Coir Fiber Baffle Detail on the Erosion Control Plans.
16. Incorporate temporary sediment basins into permanent stormwater devices.
17. Utilize Coir Wattles with Polyacrylamide (PAM) and / or TRSC-As with matting and PAM in temporary and permanent, existing and proposed ditches at a spacing of 50 feet in areas where sediment basins are not feasible at drainage outlets, and in areas where sediment basins at drainage outlets with sediment traps (i.e. PIST-A, RIST-A, etc.) cannot be properly sized to surface area and / or sediment storage requirements due to safety concerns, right of way restriction, utility conflicts, or other construction limitations approved by the Roadside Environmental Unit.
18. Place device utilizing PAM at all sediment basin inlets.
19. Do not place erosion control devices that require excavation (i.e. basins, silt ditches, etc.) in wetlands or buffer zones.
20. Within the entire project limits, provide disturbed and undisturbed drainage areas in MicroStation Format.
21. For all drainage outlets where the runoff cannot be treated with a sediment basin and / or the sediment basin cannot be constructed to the required sediment storage or surface area requirements, provide a written explanation.
22. To the maximum extent practicable, all Sediment Basins shall be placed on the perimeter of the project limits and outside of fill slopes.

C. Intermediate Phase

Intermediate Erosion Control Plans shall only be required if design modifications and / or site conditions require additional erosion control design or design revisions to the RFC Clearing and Grubbing and / or RFC Final Grade Erosion Control Plans. Intermediate Plans shall be submitted for review and shall be accepted prior to construction of any aspect impacted by the revised erosion control design. For any intermediate phase, comply with Section B, "Final Grade Phase" above.

II. Detail Sheets and Notes

- A. Provide project specific special notes and details such as skimmer basin, coir fiber wattle with Polyacrylamide (PAM), etc.
- B. Provide matting summary sheet(s): matting for erosion control and permanent soil reinforcement mat
- C. Provide reforestation sheet(s): regular, wetland, streambank and / or buffer showing appropriate species

III. Title Sheet

- A. Show correct notes: NCG-01, HQW, ESA, clearing and grubbing, etc.
- B. Show correct standards for project
- C. List of standard NCDOT symbology
- D. Show name and certification number of Level IIIA certified individual responsible for designing and/or reviewing Erosion and Sedimentation Control Plans

IV. Special Provisions

- A. Erosion Control Special Provisions are available at the following website:

http://www.ncdot.gov/doh/operations/dp_chief_eng/roadside/soil_water/special_provisions/

- B. References in Erosion Control Special Provisions from the aforementioned website to Method of Measurement, Basis of Payment, or any other statement regarding direct payment for Erosion & Sediment Control measures shall be disregarded.
- C. Erosion & Sediment Control / Stormwater Certification found elsewhere in this RFP.

V. Miscellaneous

- A. Plan submittals shall include all pertinent design information required for review, such as design calculations, drainage areas, etc.
- B. The NCDOT Roadside Environmental Unit will provide a sample set of Erosion and Sedimentation Control Plans (including any special details or special provisions used by the NCDOT Roadside Environmental Unit) and MicroStation Erosion Control Workspace to the Design-Build Team for reference upon request.
- C. Plans shall address any environmental issues raised during the permitting process.

- D. Sufficient time shall be allowed for the Design-Build Team to make any changes to the Erosion and Sedimentation Control Plans deemed necessary by the NCDOT Roadside Environmental Unit.
- E. Temporary access and haul roads, other than public roads, constructed or used in connection with the project shall be considered a part of the project and addressed in the Erosion and Sedimentation Control Plans. Temporary access and haul roads located within the footprint and ROW/Easement corridor of the project shall be part of the highway Erosion and Sedimentation Control Plans. Temporary access and haul roads associated with borrow pits and staging areas shall be included in the Reclamation Plan.
- F. Borrow or waste areas that are part of the project shall require a separate Reclamation Plan, unless the borrow or waste activity is regulated under the *Mining Act of 1971*, or is a landfill regulated by the Division of Solid Waste Management (NCDENR). For newly created borrow pit(s) that require dewatering, Borrow Pit(s) Dewatering Basins shall be required and shall be in accordance with the applicable Special Provision available at the website noted in Section IV above. The Design-Build Team shall submit the location and permit number for waste / borrow sites covered by the Mining Act or regulated by DSWM (DENR) concurrently to the Transportation Program Management Director and the Resident Engineer. For Reclamation Procedures, see:

http://www.ncdot.gov/doh/operations/dp_chief_eng/roadside/fieldops/downloads/Files/ContractedReclamationProcedures.pdf

- G. Whenever the Engineer determines that significant erosion and sedimentation continues despite the installation of approved protective practices, the Design-Build Team shall be required to and shall take additional protective action.
- H. An accepted Erosion and Sedimentation Control Plan shall not exempt the Design-Build Team from making every effort to contain sediment onsite.
- I. Any Erosion Control Design revisions made during the construction of the project shall be submitted to NCDOT REU by the 15th of the month via the Transportation Program Management Director. At anytime requested by the Engineer or the Roadside Environmental Unit, the Design-Build Team shall provide an updated version of the Erosion and Sedimentation Control Plans for distribution to all parties involved in the construction process.
- J. The Design-Build Team shall comply with the *North Carolina Administrative Code Title 15 A Department of Environment and Natural Resources Chapter 4, Sediment Control*.
- K. A pre-design meeting shall take place between the NCDOT Roadside Environmental Unit Soil & Water Engineering Section, the Design Build Team, and any other pertinent NCDOT personnel before any Erosion and Sedimentation Control Designs are submitted to NCDOT Roadside Environmental Unit. Erosion and Sedimentation Control Plan submittals shall only be reviewed and accepted by NCDOT Roadside Environmental Unit after the Erosion Control Pre-Design Meeting. The Design Build Team shall be required to submit a tentative Erosion and Sedimentation Control Plan submittal schedule at the pre-design meeting.
- L. At minimum, the Design Build Team shall bring one erosion control plan sheet with a Clearing & Grubbing erosion control design to the Erosion and Sedimentation Control Plan pre-design meeting.

- M. All RFC Erosion and Sedimentation Control Plans, including any red line revisions, shall be kept on site at all times throughout the duration of the project.
- N. Immediately after the clearing and grubbing erosion control measures have been installed for the entire project, or for individual sections if the Design-Build Team has divided the project into construction segments, the Design-Build Team's erosion and sedimentation control designer shall field verify constructed dimensions and installation of all erosion control devices. After this initial inspection(s), the aforementioned designer shall review the project conditions a minimum of every 30 days during the heavy grading operations, and as directed by the Engineer, to verify the field conditions of disturbed areas draining to erosion control devices and to ensure that the erosion control devices provide the current field condition requirements for sediment storage and surface area. During construction, the NCDOT may conduct separate field inspections of the project conditions and the erosion control devices. The erosion and sedimentation control designer shall make appropriate design revisions to the Clearing and Grubbing, Intermediate Erosion Control Plans and / or Final Grade Erosion Control Plans resulting from / required by the Design-Build Team and / or the Departmental field inspections for the Department's review and acceptance, in accordance with the Design-Build Submittal Guidelines. The Design-Build Team shall concurrently provide written documentation of all field verifications / inspections performed by the Design-Build Team to the NCDOT Roadside Environmental Unit, Soil and Water Engineering and Field Operations Section, and the Resident Engineer. At a minimum, this documentation shall detail what was observed during the field verification / inspection and all resulting required actions with a timeframe for implementation. When the project conditions no longer warrant, in the sole discretion of the Department, inspections by the erosion and sedimentation control designer may cease.
- O. The Design-Build Team's erosion and sedimentation control designer shall submit design calculations, for the Department's review and acceptance, for all modifications to the Erosion and Sedimentation Control Plans that result in dimension modifications and / or relocations, other than minor shifts to accurately place, to the devices noted below:
- Riser Basin
 - Skimmer Basin and all devices with Skimmers
 - Temporary Rock Sediment Dam Type A
 - Temporary Rock Sediment Dam Type B
 - Temporary Rock Silt Check Type A
 - Culvert Construction Sequences
 - Temporary and Permanent Stream Channel Relocations
- P. Erosion & Sediment Control / Stormwater Certification shall be required according to the Project Special Provision found elsewhere in this RFP.
- Q. Prior to installation of any erosion control devices, the Design-Build Team shall verify boundaries of jurisdictional areas in the field and delineate with Safety Fence or flagging. For guidance on Safety Fence and flagging in jurisdictional areas, see:

http://www.ncdot.gov/doh/operations/dp_chief_eng/roadside/fieldops/downloads/

- R. Once RFC Erosion and Sedimentation Control Plans are issued, any major design change or addition, any change that involves calculations, and any addition, deletion, or relocation of a sediment basin shall be submitted to the NCDOT Roadside Environmental Unit for review and acceptance. Minor changes such as moving silt fence, adding or moving temporary ditches (unless adding new runoff flow to a sediment basin), and adding or moving slope drains shall be reviewed by the Engineer in the field.
- S. All erosion control measures with stone extending beyond the construction limits shall be considered temporary fill. If impacted wetland areas are permitted as Hand Clearing, then the aforementioned temporary fill shall be permitted as Temporary Fill in Hand Cleared Areas for Erosion Control. (Reference the Environmental Permits Scope of Work found elsewhere in this RFP)
- T. Sediment basins that drain directly into jurisdictional water or have a total drainage area of one acre or more shall be designed and constructed with outlet structures that only withdraw water from the surface. For sediment basins that do not drain directly into jurisdictional water or have less than one acre of total drainage area, surface dewatering outlets and stone outlets may be provided.
- U. The person(s) responsible for the fertilizer application within the Jordan Lake Watershed shall complete the following web-based training prior to performing the work:

<http://portal.ncdenr.org/web/jordanlake/fertilizer-management>

The Design-Build Team shall be responsible for all costs associated with the aforementioned required training. The person(s) responsible for the fertilizer application within the Jordan Lake Watershed shall present a certificate of completion for the aforementioned training to the Department prior to applying the fertilizer.

V. Ground Cover Stabilization Requirements - NCG010000 (7 - 14 Days)

Ground cover stabilization shall comply with the timeframe guidelines specified by the North Carolina Department of Environment and Natural Resources Division of Water Quality NCG-010000 General Construction Permit that became effective on August 3, 2011. Excluding the slopes noted below, temporary and permanent ground cover stabilization shall be provided within seven calendar days from the last land-disturbing activity. The Design-Build Team shall label all slopes subject to the seven-day ground cover stabilization requirements on all Erosion and Sedimentation Control Plans submitted to the Department for review and acceptance.

For the slopes noted below, temporary and / or permanent ground cover stabilization shall be provided within 14 calendar days from the last land-disturbing activity:

- Slopes between 2:1 and 3:1, with a slope length of ten feet or less
- Slopes 3:1 or flatter, with a slope length of 50 feet or less
- Slopes 4:1 or flatter

Temporary and / or permanent ground cover stabilization shall be provided in accordance with the provisions in this RFP, the Vegetation Management Procedure developed by the Design-Build Team and NCG-010000.

W. Additional Ground Cover Stabilization Requirements

Once the Design-Build Team identifies the area for stabilization due to inactivity, the Design-Build Team shall obtain concurrence from the Engineer and adhere to the following options based on the estimated amount of time the area will remain inactive. If the area stabilized exceeds the estimated timeframe, the Design-Build Team shall decide implement the next level of stabilization as directed by the Engineer.

Short Term Stabilization - For areas that will remain inactive for up to 21 days

Erodible areas shall be stabilized utilizing non-vegetative cover. Non-vegetative cover options include straw mulch, hydraulic applied erosion control products or rolled erosion control products. If straw mulch is used, it shall provide 100% groundcover and be tacked sufficiently to hold the mulch in place for the duration of the inactive period. All other methods shall be installed according to the manufacturer's directions.

Mid-Term Stabilization -For areas that will remain inactive for up to 90 days

Erodible areas shall be stabilized utilizing the following stabilization protocol:

March 1 - August 31

50# German or Browntop Millet
500# Fertilizer
4000# Limestone

September 1 - February 28

50# Rye Grain or Wheat
500# Fertilizer
4000# Limestone

At the Engineer's sole discretion, the use of limestone on sandy soils that require topsoil for stabilization may be eliminated. The Design-Build Team shall consult with, and obtain approval from, the Roadside Environmental Unit prior to eliminating limestone.

Upon obtaining approval from the Engineer, the Design-Build Team may use wood mulch and / or ground clearing and grubbing debris as an option for Mid-Term Stabilization. If approved, the aforementioned mulch and / or debris shall be installed at a thickness that prevents erosion.

Long Term Stabilization - For areas that will remain inactive for more than 91 days

Erodible areas shall be stabilized utilizing the following stabilization protocol:

All Roadway Areas

March 1 - August 31

10# Centipede *
 50# Tall Fescue Cultivars **
 25# Bermudagrass (hulled)
 500# Fertilizer
 4000# Limestone

September 1 - February 28

10# Centipede *
 50# Tall Fescue Cultivars **
 35# Bermudagrass (unhulled)
 500# Fertilizer
 4000# Limestone

* On cut and fill slopes 2:1 or steeper, the Design-Build Team shall apply centipede, at a rate of five pounds per acre.

Riparian and Wetland Locations

August 1 – June 1

18# Creeping Red Fescue Cultivars ***
 6# Indiangrass
 8# Big Bluestem
 4# Switchgrass
 35# Rye Grain
 500# Fertilizer
 4000# Limestone

May 1 – September 1

18# Creeping Red Fescue Cultivars ***
 6# Indiangrass
 8# Big Bluestem
 4# Switchgrass
 25# German or Browntop Millet
 500# Fertilizer
 4000# Limestone

Waste and Borrow Locations

March 1 – August 31

75# Tall Fescue Cultivars **
 25# Bermudagrass (hulled)
 500# Fertilizer
 4000# Limestone

September 1 - February 28

75# Tall Fescue Cultivars **
 35# Bermudagrass (unhulled)
 500# Fertilizer
 4000# Limestone

**** Approved Tall Fescue Cultivars**

2nd Millennium	Duster	Magellan	Rendition
Avenger	Endeavor	Masterpiece	Scorpion
Barlexas	Escalade	Matador	Shelby
Barlexas II	Falcon II, III, IV & V	Matador GT	Signia
Barrera	Fidelity	Millennium	Silverstar

Barrington	Finesse II	Montauk	Southern Choice II
Biltmore	Firebird	Mustang 3	Stetson
Bingo	Focus	Olympic Gold	Tarheel
Bravo	Grande II	Padre	Titan Ltd
Cayenne	Greenkeeper	Paraiso	Titanium
Chapel Hill	Greystone	Picasso	Tomahawk
Chesapeake	Inferno	Piedmont	Tacer
Constitution	Justice	Pure Gold	Trooper
Chipper	Jaguar 3	Prospect	Turbo
Coronado	Kalahari	Quest	Ultimate
Coyote	Kentucky 31	Rebel Exeda	Watchdog
Davinci	Kitty Hawk	Rebel Sentry	Wolfpack
Dynasty	Kitty Hawk 2000	Regiment II	
Dominion	Lexington	Rembrandt	

***** Approved Creeping Red Fescue Cultivars**

Aberdeen	Boreal	Epic	Cindy Lou
----------	--------	------	-----------

From January 1 – December 31, the Design-Build Team shall apply an additional 20# of Sericea Lespedeza on cut and fill slopes 2:1 or steeper.

Fertilizer shall be 10-20-20 analysis or a different analysis that provides a 1-2-2 ratio applied at a rate that provides the same amount of plant food as a 10-20-20 analysis and as directed.

Soil Analysis

If vegetation establishment indicates a deficiency in soil nutrients or an incurred pH level is present, the Design-Build Team shall take soil samples and apply additional soil amendments to the affected area and as directed.

Fertilizer Topdressing

In accordance with the requirements noted below, the Design-Build Team shall apply a minimum of one Fertilizer Topdressing application to all permanently seeded areas prior to completion of the project, during every growing season from April 1st through September 31st, and as directed.

Fertilizer used for topdressing shall be 10-20-20 analysis applied at a rate of 500 pounds per acre; or a different analysis that provides a 1-2-2 ratio applied at a rate that provides the same amount of plant food as a 10-20-20 analysis and as directed.

Fertilizer used for waste and borrow areas shall be 16-8-8 grade applied at a rate of 500 pounds per acre; or a different analysis that provides a 2-1-1 ratio applied at a rate that provides the same amount of plant food as a 16-8-8 analysis and as directed.

Supplemental Seeding

For all supplemental seeding, the kinds of seed and proportions shall be the same as specified above for *Long Term Stabilization*, with the exception that centipede seed shall not be allowed in the seed mix. The rate of application for supplemental seeding shall be between 25# to 75# per acre. Prior to topdressing, the Design-Build Team shall determine the actual rate per acre for supplemental seeding and submit the supplemental seeding rate and areas to the Department for review and acceptance.

To prevent disturbance of existing vegetation, minimum tillage equipment, consisting of a sod seeder, shall be used to incorporate seed into the soil where degree of slope allows. Where degree of slope prevents the use of a sod seeder, a clodbuster (ball and chain) may be used.

Mowing

The minimum mowing height shall be four inches.

ENVIRONMENTAL INCENTIVES

The Design-Build Team will be eligible for an incentive in the amount of \$100,000 if construction operations have been performed in accordance with all environmental regulations and the Specifications, and no violations have been issued. Violations are defined as:

Violation	Issuing Entity
Immediate Corrective Action (ICA)	Department
Continuance of an ICA (CICA)	Department
Notice of Violation (NOV)	Regulatory Agencies
Cease and Desist (C&D)	Corp of Engineers

The incentive payment shall be paid at the completion of the project as long as the Design-Build Team does not receive any violations at any time during project construction.

EROSION CONTROL LIQUIDATED DAMAGES

The Design-Build Team’s first NOV or C&D violation shall result in the forfeiture of the entire \$100,000 incentive noted above or the remaining portion thereof. If \$25,000 is not available in the \$100,000 incentive noted above, the first NOV or C&D violation shall result in the forfeiture of the remaining portion plus Liquidated Damages in the amount necessary to equal \$25,000 when added to the remaining portion of the incentive. All subsequent NOV and C&D violations shall result in Liquidated Damages in the amount of \$25,000 per violation.

Each ICA and CICA violation shall result in a \$12,500 reduction from the monies remaining in the aforementioned incentive. If monies are not available in the \$100,000 incentive noted above, each ICA and CICA violation shall result in Liquidated Damages in the amount of \$12,500 per violation.

All Liquidated Damages shall be deducted from the lump sum amount for the project due the Design-Build Team.

The Design-Build Team shall observe and comply with Federal and State Laws, Local Laws, Ordinances, and Regulations; as well as Orders and Decrees of Bodies having any jurisdiction or authority in accordance with Section 107 of the 2012 *Standard Specifications for Roads and Structures*.

The Design-Build Team shall take all reasonable precautions to comply with all regulations of all authorities having jurisdiction over public and private land governing the protection of erosion and sedimentation. Any fines, remediation required or charges levied against the Department for failing to comply with all rules and regulations concerning erosion and sediment control, due to the Design-Build Team's negligence, carelessness, or failure to implement the Erosion and Sedimentation Control Plans and Specifications; or failure to maintain an approved Storm Water Pollution Prevention Plan (SWPPP), regardless of absence of neglect, shall be deducted from monies due the Design-Build Team. In addition to said fines, remediation required, or charges levied, any associated engineering costs or actions taken by the Department in order for the Department to comply with rules and regulations, as a result of the Design-Build Team's negligence, carelessness, or failure to implement the Erosion and Sedimentation Control Plans and Specifications; and / or the SWPPP, regardless of absence of neglect, shall be deducted from the monies due to the Design-Build Team.

EROSION CONTROL COORDINATION MEETINGS

Preliminary Construction Meeting

Prior to any land disturbing activity, the Engineer will schedule a meeting with Division construction personnel, Design-Build Team senior management, Design-Build Team project staff, NCDOT project staff, consultant engineering / inspection staff, NCDOT Construction Unit, NCDOT Roadside Environmental Unit, Land Quality, Department of Water Quality and any other party associated with activities that impact the overall effectiveness of the project's erosion control.

During this meeting, the attendees shall review the Design-Build Team's Traffic Control Plans and identify potential erosion control issues. All attendees will provide comments, recommendations and supportive information to help facilitate resolution to the aforementioned potential erosion control issues.

Construction Meetings

Once construction begins, the Engineer will schedule monthly meetings to review the erosion control status. All parties listed above for the Preliminary Construction Meeting shall participate in these monthly construction meetings.

During the construction meetings, the erosion control efforts / issues to date will be reviewed and discussed. Additionally, the upcoming construction phases will be reviewed to identify potential erosion control issues. After the construction meeting, a project review may occur to identify site specific issues and identify solutions. The Design-Build Team shall be responsible for all actions, corrections and / or resolutions resulting from the construction meetings and / or subsequent site visits.

The NCDOT senior management will discuss issues that are repeatedly identified on inspection reports and / or discussed during the construction meetings with the Design-Build Team's senior management.

If project activities do not change the erosion control status / conditions, the Engineer may elect to change the construction meeting frequency or cancel a meeting.

PUBLIC INFORMATION SCOPE OF WORK (4-23-13)

NCDOT will take the lead role on this project and be responsible for a portion of the public information efforts through the Department's Communications Office. Unless noted otherwise elsewhere in this RFP, the NCDOT responsibilities include:

- Organizing public meetings, including venue selection, reservation, and fee
- Providing media announcements
- Developing and producing informational print materials
- Soliciting and administering advertisements, as deemed necessary
- Mailings to the identified target audiences, including information development and postage.

The Design-Build Team shall coordinate with the Department to promote public awareness for this project. The Design-Build Team's responsibilities shall include:

- Providing details surrounding the impacts to the public
- Providing advance notice to the Department of upcoming project impacts
- Assisting the Department in the development of the target audience list
- Attending and / or speaking at public meetings
- Hand delivery of time sensitive informational materials.

The Design-Build Team shall hold an initial project coordination meeting with NCDOT one month prior to start of construction to discuss project impacts to the public. This information will be used by the Department to create a Public Information Plan.

The Design-Build Team shall inform the Department at least twenty-one (21) calendar days in advance of any construction activity that will have significant impact on the public, including, but not limited to, the start of construction, major traffic shifts, road closures, ramp closures, detours, night work and project completion.

NCDOT will develop, with the assistance of the Design-Build Team, the specific list of target audiences for this project. The following groups are identified as typical target audiences to receive informational materials:

- Governmental agencies
- Municipalities directly affected by construction
- Transportation services
- Emergency services
- Neighborhood groups and private homes
- Industry and businesses
- Chamber of Commerce
- Individual schools effected by the project
- County / City school systems
- Any other organization as deemed necessary by the Department.

The amount of public involvement required for this project is directly based on the Design-Build Team's Transportation Management Plans and construction details.

The minimum public information requirements solely associated with the Transportation Management Plans shall include, but not be limited to the following:

- Public Meetings – If Beginning of Construction meeting for area businesses and residents is held, attending and / or speaking at this event.
- Distribution of Informational Materials - For beginning of construction and for all road closures with detour routes, the Design-Build Team shall be responsible for delivering time sensitive informational material provided by the NCDOT directly to portions of the target audience. If the Design-Build Team informs the Department of the aforementioned activities less than twenty-one (21) calendar days in advance, the Design-Build Team shall hand deliver the informational materials to the impacted target audiences.

The Department will be responsible for establishing, creating, maintaining and updating the project website for this project. However, throughout the project duration, the Design-Build Team shall coordinate with the NCDOT Communications Office to ensure the accuracy of the aforementioned project updates. At a minimum, the Design-Build Team shall designate a contact for public information inquiries / coordination. Throughout construction, this contact shall provide weekly updates to the NCDOT Communications Office, including, but not limited to, traffic control phasing, graphic illustrations, project pictures, etc.

The Design-Build Team shall include in their Lump Sum Bid price for the project, all costs associated with their involvement in the Public Information Scope of Work.

ENVIRONMENTAL PERMITS SCOPE OF WORK (12-17-13)**General**

The Department will provide the US Army Corps of Engineers (USACE) Section 404 Permit and the NC Department of Natural Resources (DENR) Division of Water Quality (DWQ) Section 401 Water Quality Certification for the R-2413A and R-2413B sections of the project. If permit modifications are required by the proposed design and / or construction methods, the Design-Build Team shall be responsible for completing all permit modification applications, including but not limited to developing all permit drawings.

The Design-Build Team shall be responsible for preparing all documents necessary for the Department to obtain the environmental permits required for the I-5110 section of the project. Permit applications shall be required for the US Army Corps of Engineers (USACE) Section 404 Permit, NC Department of Natural Resources (DENR) Division of Water Quality (DWQ) Section 401 Water Quality Certification, and a NCDWQ Riparian Buffer Authorization for the I-5110 section of the project.

The Design-Build Team shall not begin ground disturbing activities, including utility relocations and / or tree harvesting, (this does not include permitted investigative borings covered under a Nationwide Permit No. 6 or utility relocation work outside jurisdictional resources noted below) until a meeting is held between the NCDOT, the regulatory agencies and the Design-Build Team. The Design-Build Team shall coordinate with the Transportation Program Management Director to determine if a Preconstruction notification (PCN) is required for the nationwide Permit No. 6. If a PCN is required, the Design-Build Team shall submit all necessary documents and forms to the Transportation Program Management Director for submittal to the appropriate agencies. If a PCN is not required, the Design-Build Team may proceed with geotechnical investigations outside jurisdictional resources, provided all Nationwide Permit No. 6 Conditions are adhered to. Furthermore, with the exception of those sites already permitted under the R-2413A and R-2413B permits, no ground disturbing activities unrelated to advancing construction of the taxiway bridge shall occur on the I-5110 section of the project until the required I-5110 permits have been acquired.

The Design-Build Team may begin utility relocation work and may begin clearing, grubbing, drainage and grading necessary to advance the construction of the taxiway bridge prior to obtaining the aforementioned permits provided that (1) the Department is notified in writing prior to these activities; (2) such activities are outside jurisdictional resources; (3) a meeting is held with the NCDOT and permitting agencies prior to beginning work, if necessary; (4) the Design-Build Team demonstrates that the utility relocation work and / or the aforementioned activities for advancing the taxiway bridge construction do not impact jurisdictional features; and (5) the Design-Build Team submits a Preconstruction Notification for the Department to forward to the permitting agencies, if necessary.

The Department shall allow no direct contact between the Design-Build Team and representatives of the environmental agencies. No contact between the Design-Build Team and the environmental agencies shall be allowed either by phone, e-mail or in person, without representatives of the

Department's Project Development and Environmental Analysis Unit – Natural Environment Section (PDEA-NES) and / or the Division Environmental Officer (DEO) present. A representative from the NCDOT Transportation Program Management Unit shall be included on all correspondence.

Direct coordination between the Design-Build Team, the Department's Transportation Program Management Director, Resident Engineer, Division Environmental officer (DEO) and the PDEA-NES shall be necessary to ensure proper permit application development. Upon completion of the permit application package, the Design-Build Team shall concurrently forward the package to the Transportation Program Management Director, Resident Engineer, Division Environmental Officer and PDEA-NES for review and approval. After all revisions are complete, the Department (PDEA-NES) will subsequently forward the final package to the appropriate environmental agencies to have the permit application placed on public notice.

The Design-Build Team shall analyze all new areas to be impacted that have not been analyzed during the NEPA Process, including but not limited to all staging areas that are located outside the project right of way. This analysis shall include performing all environmental assessments. These assessments shall require the Design-Build Team to engage the services of a competent environmental consultant to conduct a full environmental investigation to include, but not be limited to, Federally Listed Threatened and Endangered Species, wetlands, streams, avoidance and minimization in jurisdictional areas, compensatory mitigation, FEMA compliance, and historical, archaeological, and cultural resources surveys in these areas. The environmental consultant shall obtain concurrence through PDEA-NES from the United States Fish and Wildlife Service to document compliance with Section 7 of the *Endangered Species Act* for those species requiring such concurrence. In addition the Design-Build Team shall identify additional mitigation required, identify the amount of time beyond the permit timeframes noted below, and fulfill all other requirements that the permitting agencies impose to obtain the permit. Any contract time extensions resulting from additional environmental assessments required by the Design-Build Team's design and / or construction methods impacting areas outside those previously analyzed through the NEPA Process shall be solely at the Department's discretion.

The Design-Build Team needs to be aware that the timeframes listed for the Project Development and Environmental Analysis Branch - Natural Environment Section (PDEA-NES), NCDWQ and the USACE to review a permit application begin on the date of a fully complete and 100% accurate permit application submittal to the PDEA-NES.

The Department will re-verify and update, as needed, the required environmental data that expires prior to the completion of the activity causing the impact in the jurisdictional areas. These include, but are not limited to federally protected species; re-verification of wetland, stream and riparian buffer jurisdictional areas; historic and archaeological sites; and 303(d) (impaired) streams.

Unless noted otherwise elsewhere in this RFP, the Department will not honor any requests for additional contract time or compensation for any efforts required in order to obtain any permit or permit modification, including but not limited to public involvement, additional design effort,

additional construction effort and / or additional environmental agency coordination and approvals.

R- 2413A & R-2413B

The Department has reached Concurrence Point 4C in the R-2413A & B Merger Process used by the environmental agencies and the Department to obtain environmental permits for projects. Any variations in the Department's proposed design, including all design revisions required by this RFP, and / or construction methods that nullify any Concurrence Points obtained or decisions reached between the Department and the environmental agencies; and / or require additional coordination with the Environmental Agencies shall be the sole responsibility of the Design-Build Team. The Department will not allow any contract time extensions associated with this additional coordination. The Design-Build Team shall follow the appropriate details in the document titled *Merger Implementation Team – Merger Process Information* which may be referenced on the website below:

<https://connect.ncdot.gov/resources/Environmental/Pages/Merger.aspx>

The NCDOT has submitted permit applications to the NC Division of Water Quality (DWQ) and the US Army Corp of Engineers (USACE) for an Individual Permit. An USACE Jurisdictional Determination is forthcoming with the permit. Updated surveys for federally protected species were conducted in May 2013 by NCDOT biologists.

In accordance with the requirements noted below, the Design-Build Team shall obtain the permit modifications required for the Service Road -Y1C- design revisions. (Reference the Roadway Scope of Work found elsewhere in this RFP)

I-5110

This project is in the design phase and most likely will require an Individual Permit. In August 2011, the USACE verified jurisdictional waters of the US. In June 2011, federally protected species surveys were completed and habitat was deemed present for small-whorled pogonia. Based on the Department's preliminary design, a biological conclusion of No Effect was issued. A federally protected species resurvey will be required prior to May / June 2016 only if the I-5110 permits have expired or are no longer valid.

The Department has reached Concurrence Point 4A in the I-5110 Merger Process used by the environmental agencies and the Department to obtain environmental permits for projects. The Design-Build Team shall participate and present information for Concurrence Points 4B and 4C that are necessary to complete the Merger Process. Any variations in the Department's proposed design and / or construction methods that nullify any Concurrence Points obtained or decisions reached between the Department and the environmental agencies; and / or require additional coordination with the Environmental Agencies shall be the sole responsibility of the Design-Build Team. The Department will not allow any contract time extensions associated with this additional coordination. The Design-Build Team shall follow the appropriate details in the document titled *Merger Implementation Team – Merger Process Information* which may be referenced on the website below:

<https://connect.ncdot.gov/resources/Environmental/Pages/Merger.aspx>

Unless otherwise stipulated in the Technical Proposal, the Department will schedule the 4B and 4C Meetings for I-5110 for September 2014 and November 2014, respectively. The Design-Build Team shall clearly identify in their Technical Proposal what months they would like the Department to schedule these meetings. Failure on the part of the Design-Build Team to meet these dates shall place all responsibility for delays resulting from missing these dates solely in the hands of the Design-Build Team.

Permit Application and Permit Modification Application Processes

It shall be the Design-Build Team's responsibility to acquire information and prepare permit drawings that reflect the impacts and minimization efforts resulting from the Merger Process and from the project as designed by the Design-Build Team. Further it shall be the Design-Build Team's responsibility to provide these permit impact sheets (drawings) depicting the design and construction details to the Department as part of the permit application. The Design-Build Team shall be responsible for developing the permit modification application for all jurisdictional impacts. The permit application shall include all utility relocations required by the project. At a minimum, the permit application shall consist of the following:

Cover Letter

Minutes from the 4B and 4C Meetings

Wetland / Stream and Buffer Permit drawings (with and without contours)

Stormwater Management Plan

Half-size plans

Completed forms (Section 404 ENG 4345, etc.) appropriate for impacts

Any temporary construction measures, including de-watering, construction access, etc. shall be addressed in the permit application. Impacts that result from so-called temporary measures may not be judged to be temporary impacts by the agencies. These issues shall be addressed and reviewed by PDEA-NES. For I-5110, these issues shall be addressed and reviewed by PDEA-NES a minimum of two weeks prior to the 4C Meeting and resolved with the agencies during the 4C Meeting.

The Design-Build Team shall clearly indicate the location of and impacts of haul roads and utility relocations in jurisdictional areas. The Design-Build Team shall also identify all proposed borrow and waste sites. Further, the Design-Build Team shall describe the construction methods of all structures. The temporary impact descriptions (haul roads, utility relocations, work bridges, etc.) shall include restoration plans, schedules and disposal plans. The aforementioned information, descriptions and details shall be presented during the I-5110 4C Meeting and included in all permit applications.

Requests made for modifications to the permits obtained by the Design-Build Team shall only be allowed if the Engineer determines it to be in the best interest of the Department and shall be strongly discouraged. The Design-Build Team shall not take an iterative approach to hydraulic design issues. The design shall be final and complete prior to permit application.

The Design-Build Team shall adhere to all Jordan Buffer Authorization requirements associated with additional stream impacts in accordance with 15A NCAC 02B.0267. Only the area impacted outside the original permitted area will be subject to the aforementioned requirements. Buffer Permit Drawings will only be required for increases in stream impacts at any given site that fall in either the Allowable or Allowable with Mitigation category, as defined in the Table of Uses. The Design-Build Team shall be responsible for all costs associated with the additional stream impacts. The Department will not honor any requests for additional contract time or compensation, including idle equipment or mobilization / demobilization costs, for the Design-Build Team mobilizing men, materials (or ordering materials), or equipment prior to obtaining the necessary Jordan Buffer Authorization required for additional stream impacts.

R-2413A & R-2413B Major Permit Modification Timeframe

Depending on the complexity of the proposed changes, the Design-Build Team should expect it to take up to four months to obtain a permit modification approval from the environmental agencies. Prior to submittal to the environmental agencies, the Department's PDEA-NES Section shall require ten full working days to review the permit modification application. No requests for additional contract time or compensation will be allowed if the permits are not obtained within this four-month period.

With the exception of location and survey work, utility relocations outside jurisdictional resources that adhere to the aforementioned requirements, permitted investigative borings covered under a Nationwide Permit No. 6 and / or Preconstruction Notification secured by the Design-Build Team, no mobilization of men, materials, or equipment for site investigation or construction of the project section covered by the proposed permit modification(s) shall occur prior to obtaining the permit modification(s) (either within the four-month period or beyond the four-month period). The Department will not honor any requests for additional contract time or compensation, including idle equipment or mobilization / demobilization costs, for the Design-Build Team mobilizing men, materials (or ordering materials), or equipment prior to obtaining the necessary permit modification(s).

The Department will not honor any requests for additional contract time or compensation for any efforts required in order to obtain any permit modification(s), including but not limited to public involvement, additional design effort, additional construction effort and / or additional environmental agency coordination and approvals unless the Design-Build Team has pursued the work with due diligence, the delay is beyond the Team's control, and the 4-month period has been exceeded. If extension of contract time is granted, such extension will only be for that time exceeding the 4-month period. This 4-month period is considered to begin upon submission of a complete and accurate permit modification package to the permitting agencies.

I-5110 Individual Permit Timeframe

The Design-Build Team shall submit one permit application for I-5110. The Design-Build Team shall not submit multiple applications to develop a "staged permitting" process to expedite construction activities in a phased fashion.

The Design-Build Team should expect it to take up to 11 months to accurately and adequately complete all designs necessary for the permit application, submit the application to the Department and obtain approvals from the environmental agencies. Prior to submittal to the environmental agencies, the Department's PDEA-NES Section shall require ten full working days to review the permit application. Environmental agency review time will be approximately 100 days from receipt of a "complete" package. No requests for additional contract time or compensation will be allowed if the permits are obtained within this 11-month period. With the exception of 1) location and survey work; 2) utility relocations outside jurisdictional resources that adhere to the aforementioned requirements; 3) permitted investigative borings covered under a Nationwide Permit No. 6 and / or Preconstruction Notifications secured by the Design-Build Team; and 4) activities in non-jurisdictional areas that advance the taxiway bridge construction, no mobilization of men, materials, or equipment for site investigation or construction of the project shall occur prior to obtaining the permits (either within the 11-month period or beyond the 11-month period). The Department will not honor any requests for additional contract time or compensation, including idle equipment or mobilization / demobilization costs, for the Design-Build Team mobilizing men, materials (or ordering materials), or equipment prior to obtaining all permits. The Department will consider requests for contract time extensions for obtaining the permits only if the Design-Build Team has pursued the work with due diligence, the delay is beyond the Team's control, and the 11-month period has been exceeded. If time were granted, it would be only for that time exceeding the 11-month period. This 11-month period is considered to begin on the Date of Availability as noted elsewhere in the RFP.

Mitigation Responsibilities

As required by the NEPA Process and the CWA Section 404(b)(1) Guidelines to offset potential wetland and stream impacts, PDEA-NES's Indirect and Cumulative Impact and Engineering Groups have reviewed the roadway project corridor for potential on-site mitigation opportunities. On-site mitigation opportunities were identified and proposed in the R-2413A and R-2413B permit application (Reference the On-Site Mitigation Scope of Work found elsewhere in this RFP). No on-site mitigation opportunities were identified for I-5110.

Based on the preliminary roadway plans (R-2413A & B Right of Way Plans and I-5110 Hearing Map), the Department has acquired the compensatory mitigation to offset unavoidable impacts to wetlands, surface waters and buffers not offset with the aforementioned on-site mitigation from the Ecosystem Enhancement Program. Should additional jurisdictional impacts result from design revisions not required by this RFP and / or construction methods, suitable compensatory mitigation for wetlands, stream and / or buffers shall be the sole responsibility of the Design-Build Team. Therefore, it is important to note that additional mitigation must be approved by the environmental agencies and such approval shall require, at a minimum, the preparation and approval of a Mitigation Plan before permits / permit modifications are approved and before construction may commence. To mitigate for these additional jurisdictional impacts, the Design-Build Team shall be responsible for all costs associated with acquiring suitable mitigation. Construction of any on-site mitigation shall be performed by a contractor that has successfully constructed similar on-site mitigation. In the absence of suitable on-site mitigation,

the Design-Build Team shall be responsible for acquiring additional mitigation from the Ecosystem Enhancement Program or an approved compensatory mitigation banking resource.

Commitments

The NCDOT hereby commits to ensuring, to the greatest extent possible, that the footprint of the impacts in areas under the jurisdiction of the Federal Clean Water Act will not be increased during the Design-Build effort. All fill material shall be immediately stabilized and maintained to prevent sediment from entering adjacent waters or wetlands. The Design-Build Team shall be responsible for ensuring that the design and / or construction of the project will not impair the movement of aquatic life.

The NCDOT is committed to incorporating all reasonable and practicable design features to avoid and minimize wetland, stream and buffer impacts and to provide full compensatory mitigation of all remaining wetland, stream and buffer impacts. Avoidance measures were taken during the planning and NEPA Process and minimization measures were incorporated as part of the preliminary design. The Design-Build Team shall incorporate these avoidance and minimization features, plus any minimization identified during the I-5110 4B and 4C Meetings, into the design.

Unless otherwise noted in this RFP, the Design-Build Team shall be bound by the terms of all signed NEPA documents and approved minutes and commitments of all concurrence meetings, and shall be held accountable for performing work in compliance with all permit, certification and / or authorization (permits) conditions. The Design-Build Team shall staff any personnel necessary to provide the aforementioned compliance.

All work performed by the Design-Build Team shall be accomplished in strict compliance with the plans submitted with the permit applications. The Design Build Team shall provide each of its contractors and / or agents associated with the construction or maintenance of this project with a copy of the permits.

Unless noted otherwise elsewhere in this RFP, the Design-Build Team shall strictly adhere to these commitments, as well as others, including but not limited to those included in the environmental documents (Environmental Assessments, Finding of No Significant Impacts and / or Categorical Exclusion), all permits, Merger Meetings and site visits.

If the Design-Build Team discovers any previously unknown historic or archeological remains while accomplishing the authorized work, they shall immediately notify the NCDOT Staff Archaeologist and / or NCDOT Project Development Engineer, as listed below, who will initiate the required State / Federal coordination. The Design-Build Team shall also immediately notify a representative from the Transportation Program Management Unit. All questions regarding these sites shall be addressed to Mr. Matthew Wilkerson, NCDOT Archaeology (919) 707-6089, or Mr. Ahmad Al-Sharawneh, PE, NCDOT Project Development Engineer (919) 707-6010. The NCDOT Transportation Program Management Unit shall be included on all correspondence.

ON-SITE MITIGATION SCOPE OF WORK (10-31-13)**General**

As required by the NEPA process and USACE/EPA Guidelines, to offset potential wetland and stream impacts, the Design-Build Team shall be responsible for the construction of all on-site mitigation identified in this Scope of Work, including but not limited to, the following:

The Design-Build Team shall be responsible for fulfilling all permit conditions. The Design-Build Team shall be responsible for ensuring that all stream mitigation sites are constructed according to the permitted mitigation design and construction plans provided by the Department. The Design-Build Team shall not be responsible for post-construction monitoring after completion of the required Twelve-Month Guarantee described elsewhere in this RFP or as otherwise offered by the Design-Build Team in the Technical Proposal.

The Department has provided the permitted On-site Mitigation Plan narrative and design plan sheets. The Department will be responsible for revisions to these plans for errors and omissions; however, if the Design-Build Team revises the plans (roadway alignments, culvert invert elevations, etc.) in the vicinity of these stream mitigation sites, the Design-Build Team shall be responsible for all preconstruction work that may be necessary to adjust or revise the On Site Mitigation Plans and narrative and submit for review and acceptance by the Department. The Design-Build Team shall also be responsible for preparing any permit modifications as described in the Environmental Permits Scope of Work that may be necessary to reflect modifications to on site mitigation work.

The Design-Build Team shall note in their Technical Proposal the subcontractor(s) that they intend to use for the stream mitigation construction.

The Department will be responsible for invasive species management throughout all mitigation sites.

Site Specific Information**Site 1 (WM 041-034)**

A combination of Priority II and Priority I restoration is proposed for the upper reach of the Site 1 stream channel. The channel is currently an incised G5 Rosgen stream type channel that will be restored to a stable C5 channel by establishing a lower valley at the bankfull elevation for the upstream portion then gradually elevating the stream channel to allow bankfull and higher flows access to the existing floodplain prior to flowing into the proposed 72" culvert under the new roadway alignment. Priority I restoration is proposed for the lower reach of Site 1. The existing channel classifies as an incised G5 Rosgen stream type that will also be restored to a stable C5 channel. As channel flow exits the 72" culvert under the proposed roadway it will flow into a stream channel that will be elevated to allow proper floodplain access at the bankfull elevation on new location. The stream channel will be relocated back to the center of the existing valley.

Proper sinuosity and radius of curvature will be restored to both the upper and lower stream reaches to provide stability. Proper riffle-pool sequencing will also be returned to the channels along with in-stream rock and log structures to provide immediate grade control of the newly excavated channels. The installation of these structures will increase stability of the profile and banks while allowing time for vegetation to establish and natural bed materials to be transported throughout the system. Special attention must also be given to the possible change in flow regime in this system as it may be influenced by storm water runoff from the proposed roadway. The proposed riparian buffer for Site 1 upper extends a minimum of 50 feet from the top of bank from both sides of the stream channel and totals approximately 1.97 acres. The proposed riparian buffer for Site 1 lower will extend a minimum of 50 feet from the top of bank on both sides and would require a minimum of 1.27 acres. Design parameters for the proposed stream can be found on plan sheets OSM-4, -5, -12, and -13 and in the morphological table on OSM-2E. Parameters for buffer reforestation can be found on plan sheets RF-01, -02, -03, and -04.

Site 2 (WM 041-035)

The upper reach of the existing stream channel on Site 2 will be relocated away from the toe of fill material using a Priority I restoration approach. The existing channel in this location is fairly stable but will be directly impacted by the fill slope as shown in the on-site mitigation construction drawings. The existing upper reach channel transitions from a B5 at the upper extent of the project to an E5 where the channel will be impacted by the future roadway work. The relocated channel will be designed as a C5 channel with gradual 3:1 side slopes that will be planted and will eventually transition to an E5 channel over time as the channel narrows. The lower reach of Site 2 Classifies as an E5 channel that transitions to a G5 channel downstream of a large 4.0 foot head cut that is moving up through the system. This lower reach begins at the outlet of the proposed 54 inch culvert and it is anticipated that the roadway drainage would expedite the upstream progression of the existing head cut. The proposed restored lower reach channel will also be designed as a C5 channel with gradual 3:1 side slopes that will be planted and eventually transition to an E5 channel as the channel narrows over time.

Appropriate sinuosity and radius of curvature will be restored to both the upstream and downstream reach channels to provide stability. The channels will be elevated to their historic floodplain in some locations where possible, improving their cross sectional dimension and allowing bankfull and higher flows to access the floodplain. Proper riffle-pool sequencing will also be returned to the channels with corrected pattern and the installation of rock and log structures. The installation of these in-stream structures will increase stability of the profile and banks while allowing time for vegetation to establish and natural bed materials to be transported throughout the system. Special attention must also be given to the possible change in flow regime in this system as it may be influenced by storm water runoff from the proposed roadway. The proposed riparian buffer for Site 2 upper extends a minimum of 50 feet from the top of bank from both sides and would require approximately 1.33 acres. The required buffer will be included within proposed right-of-way. The proposed riparian buffer for Site 2 lower will extend a minimum of 50 feet from the top of bank on both sides and would require a minimum of 1.48 acres. Due to the fact that Site 1 lower and Site 2 lower are located adjacent to each other on the north side of the proposed roadway, the proposed right-of-way will include Site 1 lower, Site 2 lower, their respective riparian buffers and the forested drainage area between the two. Design

parameters for the proposed stream can be found on Plansheets OSM-6, -7, -14, and -15, and in the morphological table on OSM-2F. Parameters for buffer reforestation can be found on plan sheets RF-01, -02, -05, and -06.

Site 4 (WM 041-037)

A Priority II restoration approach is proposed for the stream reach at Site 4. The current channel classifies as a Rosgen E5 stream channel and flows through an existing culvert under Brookbank Road. The proposed restoration of this reach will consist of excavating a new stream channel and floodplain through the existing Brookbank Road fill material. This road will be abandoned with the proposed improvements associated with R-2413A&B and presents an opportunity to reconnect the upstream floodplain with the floodplain downstream of the existing roadway fill. The proposed channel through this reach will be a C5 channel. Banks and floodplain will be planted with native species and the channel is expected to narrow over time to an E5 channel. The proposed reach is not long enough to establish pattern within the restored reach, but in-stream log cross vanes will be installed to provide profile stabilization and in-stream habitat. Design parameters for the proposed stream can be found on plansheets OSM-09 and -17, and in the morphological table on OSM-2G. The proposed riparian buffer for this channel would extend 50 feet from the top of bank from both sides and would total approximately 1.01 acres. Parameters for buffer reforestation can be found on plansheets RF-01, -02, and -08.

Site 5 (WM 041-038)

The upper reach of Site 5 will be restored using Priority I restoration. The existing channel will be relocated to the center of the existing floodplain and elevated so that bankfull and higher flows can access the existing floodplain. The lower reach of Site 5 will be restored by re-establishing a natural stream channel and proper floodplain through the existing dam. The existing stream channel breached the dam along the east side of the floodplain and is therefore currently eroding the toe of the existing floodplain and the fill material of the old dam. The channel will be relocated back to the center of the existing floodplain and a significant portion of the dam will be removed to ensure the upstream floodplain is hydraulically connected to the lower floodplain. The existing channels at Site 5 classify as incised E5 channels that are actively eroding in an effort to re-establish appropriate pattern and dimension. The appropriate dimension, pattern, and profile will be restored to the relocated channels in both the upper and lower reaches. Special attention will be given to the change in flow regime that could occur from the storm water runoff of the proposed roadway. A Rosgen type C5 channel is proposed for both the upstream and downstream reaches. Rock and log in-stream structures will be installed along the restored reaches to ensure that the newly constructed stream channels remain stable until mature vegetation is established on the banks and native bed material is transported into the relocated channels. Design parameters for the proposed stream can be found on plansheets OSM-10, -11, -18, and -19 and in the morphological table on OSM-2G. The proposed riparian buffer for this channel would extend 50 feet from the top of bank from both sides and would total approximately 2.18 acres. The required buffer will be included within proposed right-of-way in order to provide easements along proposed cut lines associated with the proposed stream restoration and to ensure a 50 foot minimum riparian buffer is provided on all stream reaches. Parameters for buffer reforestation can be found on plansheets RF-01, -02, -09, and -10.

Site Construction

NCDOT's Natural Environment Section's Engineering Group and On-site Mitigation Group staff shall be contacted for field review and approval of site stake out before construction begins. The Natural Environment Section staff shall be given 48 hour notice in order to approve the stake out. Staff from the Natural Environment Section's Engineering Group will be available on an as needed basis to provide construction assistance during construction.

Stream Construction

Construction of the stream shall be done in accordance with the approved permit drawings, mitigation plan, and design/construction plans provided by the Department. The Design-Build Team shall follow all NCDOT standards and specifications set forth in the construction plans. The Design-Build Team shall coordinate with the Department's On-site Mitigation Group on-site as needed during the construction of the stream. Any and all field alterations/changes to the approved design shall be approved by the Department/Engineer prior to incorporation. All changes that are made as a result of, but not limited to, the existing field conditions shall be noted and included in the as-built plans. The as-built plans for the stream relocations/mitigation shall be submitted to NCDOT within 60 days of completion of the stream to meet permit requirements. The Design-Build Team shall be responsible for any and all remediation activities at the sites through the end of the Twelve Month Guarantee period for the project. The Design-Build Team shall also be responsible for establishing any post construction monitoring criteria as stated in the approved permit/mitigation plan. This includes, but is not limited to, permanent cross sections, longitudinal profile stationing, vegetation plots, and photo point locations. The Design-Build Team shall use GPS and MicroStation to compile this information, along with the as-built plans. This information shall then be provided to NCDOT in electronic, as well as hard copy, format within 60 days of completion of construction.

LIGHTING SCOPE OF WORK (9-26-13)

The Design-Build Team shall provide and install taxiway underpass lighting equipment and materials, in accordance with the Final Lighting Plans provided by the Department, Division 14 of the 2012 NCDOT *Standard Specifications for Roads and Structures*, and the *Roadway Standard Drawings*, except as amended below. Prior to the Technical Proposal submittal date, the NCDOT will provide the Preliminary Lighting Plans. The Department will finalize the lighting design based upon the Design-Build Team's Release for Construction (RFC) Taxiway Structural Plans.

The Design-Build Team shall include all costs required to construct the taxiway underpass lighting shown in the aforementioned Preliminary Lighting Plans provided by the Department in their lump sum price bid for the entire project. The Department shall only compensate the Design-Build Team for additional lighting construction costs that result from design revisions incorporated at the Department's discretion and / or that result from errors or omissions in the Department's Preliminary Lighting Plans. The Design-Build Team shall be solely responsible for all additional lighting construction costs that result from design revisions incorporated at the Design-Build Team's discretion.

After the RFC Taxiway Structural Plans have been accepted by the Transportation Program Management Director, the Design-Build Team shall submit MicroStation files of the RFC Taxiway Structural Plans for the Department to complete the lighting design. The Design-Build Team shall allow the Department ten business days after this submittal to update and finalize the lighting design.

The Design-Build Team shall allow ten days for Department review of each material submittal for the components of the underpass lighting system.

MAINTENANCE

The Design-Build Team shall assume responsibility for routine maintenance of the lighting system(s) for the duration of the contract in accordance with Division 14 of the 2012 NCDOT *Standard Specifications for Roads and Structures*, except as amended below:

- NCDOT will assume maintenance responsibility for the completed lighting system(s) after the project is accepted, and there is no chance of construction-related damage.
- The Design-Build Team shall re-lamp, repair and / or replace any newly installed non-functional underpass luminaires. All underpass luminaires must be operational at project acceptance.

JUNCTION BOXES

Excluding the modifications noted below to the referenced Section 1091-5, the Design-Build Team shall adhere to all requirements of Section 1411 of the 2012 *Standard Specifications for Roads and Structures*:

- Page No. 10-202, revise the paragraph starting on Line 9 to read "Provide polymer concrete (PC) boxes which have bolted covers and open bottoms."
- Page No. 10-202, revise the sentence beginning on Line 14 to read "Other thermoplastic materials may be used for components which are not normally exposed to sunlight."

PAVEMENT MARKING SCOPE OF WORK 10-31-2013**General**

The Design-Build Team shall prepare Final Pavement Marking Plans in accordance with the 2009 edition of the *Manual on Uniform Traffic Control Devices (MUTCD)*, the NCDOT Roadway Standard Drawings (January 2012), “*Guidelines for Preparation of Traffic Control and Pavement Marking Plans for Design-Build Projects*”, and the “*Design-Build Submittal Guidelines*” and the contract requirements contained herein.

Final Pavement Marking Plan Requirements

The Design-Build Team shall select a Private Engineering Firm (PEF) that has experience designing and sealing Pavement Marking Plans for NCDOT on comparable projects.

The Design-Build Team shall develop Pavement Marking Plans that maintain all types of traffic (motorists, bicyclists, and pedestrians within the highway, including persons with disabilities in accordance with the Americans with Disabilities Act of 1990 (ADA), Title II, Paragraph 35.130) as defined by the *Manual for Uniform Traffic Control Devices (MUTCD)*.

Final Pavement Marking Project Limits

The Final Pavement Marking Plans shall address any required modifications to existing pavement markings located outside the project limits to ensure appropriate tie-ins. The Design-Build Team shall be responsible for installing all pavement markings and markers located within and outside the project limits, resulting from the project construction.

Pavement Markings, Markers and Delineation

The Design-Build Team shall not place any final pavement markings and markers until the Final Pavement Marking Plans are submitted for review and acceptance.

The Design-Build Team shall use pavement marking and marker products that conform to all NCDOT requirements and are listed on the NCDOT’s Approved Products List. The use of any devices that are not shown on the Approved Product List shall require written approval from the Engineer.

The Design-Build Team shall install pavement markings and markers in accordance with the NCDOT 2012 *Standard Specifications for Roads and Structures*, and in accordance with the manufacturer’s procedures and specifications.

The Design-Build Team shall install pavement markings and pavement markers on the final surfaces as follows:

Road	Marking	Marker
Asphalt Surfaces	Thermoplastic	Snowplowable on -L- Line Match existing on -Y- Lines
Concrete Surfaces	Polyurea with Highly Reflective Elements	Snowplowable on -L- Line Match existing on -Y- Lines
Bridge Decks	Polyurea with Highly Reflective Elements	Raised

On asphalt surfaces, the Design-Build Team shall install Heated-in-Place Thermoplastic or Extruded Thermoplastic markings for stop bars, symbols, characters, crosswalks and diagonals.

On concrete surfaces, the Design-Build Team shall install Heated-in-Place Thermoplastic for stop bars, symbols, characters, crosswalks and diagonals.

Prior to placing pavement marking material on concrete surfaces that are diamond ground, the Design-Build Team shall remove longitudinal grooves by grinding.

Using approved methods, the Design-Build Team shall remove residue and surface laitance on concrete bridge decks prior to placing final pavement marking materials. Curing compound removal shall be included in the contract for all other concrete surfaces.

All Full Control of Access interstate facilities and US routes require 6-inch wide pavement markings, i.e., lane lines, edge lines and skips for the final pavement marking. The Design-Build Team shall install gore lines that are twice the edge line thickness.

The Design-Build Team shall tie proposed pavement marking lines to existing pavement marking lines.

The Design-Build Team shall replace any pavement markings that have been damaged by the end of each day's operation.

The Design-Build Team shall only remove pavement markings from concrete surfaces by hydroblasting, waterblasting, or grinding (waterblasting is not allowed on asphalt surfaces for the removal of markings).

***** PROJECT SPECIAL PROVISION *****

(10-18-95)

Z-1

PERMITS

The Design-Build Team's attention is directed to the following permits that have been issued to the Department of Transportation by the authority granting the permit.

PERMIT**AUTHORITY GRANTING THE PERMIT**

Dredge and Fill and / or Work in Navigable Waters (404)	U. S. Army Corps of Engineers
Water Quality (401)	Division of Environmental Management, DENR State of North Carolina

The Design-Build Team shall comply with all applicable permit conditions during construction of this project. Those conditions marked by * are the responsibility of the department and the Design-Build Team has no responsibility in accomplishing those conditions.

Agents of the permitting authority will periodically inspect the project for adherence to the permits.

The Design-Build Team's attention is also directed to Articles 107-10 and 107-14 of the *Standard Specifications* and the following:

Should the Design-Build Team propose to utilize construction methods (such as temporary structures or fill in waters and / or wetlands for haul roads, work platforms, cofferdams, etc.) not specifically identified in the permit (individual, general, or nationwide) authorizing the project it shall be the Design-Build Team's responsibility to coordinate with the Engineer to determine what, if any, additional permit action is required. The Design-Build Team shall also be responsible for initiating the request for the authorization of such construction method by the permitting agency. The request shall be submitted through the Engineer. The Design-Build Team shall not utilize the construction method until it is approved by the permitting agency. The request normally takes approximately 60 days to process; however, no extensions of time or additional compensation will be granted for delays resulting from the Design-Build Team's request for approval of construction methods not specifically identified in the permit.

Where construction moratoriums are contained in a permit condition which restricts the Design-Build Team's activities to certain times of the year, those moratoriums will apply only to the portions of the work taking place in the waters or wetlands provided that activities outside those areas is done in such a manner as to not affect the waters or wetlands.



North Carolina Department of Environment and Natural Resources

Division of Water Resources

Water Quality Programs

Thomas A. Reeder

Director

Pat McCrory
Governor

John E. Skvarla, III
Secretary

October 28, 2013

Mr. Richard W. Hancock, P.E., Manager
Project Development and Environmental Analysis
North Carolina Department of Transportation
1598 Mail Service Center
Raleigh, North Carolina, 27699-1598

Subject: 401 Water Quality Certification Pursuant to Section 401 of the Federal Clean Water Act with
ADDITIONAL CONDITIONS for Proposed new location facility from SR 2011 (Edgefield Road) to the
Haw River at US 220 in Guilford County, WBS Element No. 34429.1.1. TIP No. R-2413AB.
NCDWR Project No. 20130517.

Dear Mr. Hancock:

Attached hereto is a copy of Certification No. 3971 issued to The North Carolina Department of Transportation
(NCDOT) dated October 28, 2013. This certification replaces the certification issued to you on October 11, 2013.

If we can be of further assistance, do not hesitate to contact us.

Sincerely,

Thomas A. Reeder

Attachments

cc: Andy Williams, US Army Corps of Engineers, Raleigh Field Office (electronic copy only)
Jerry Parker, PE, Division 7 Engineer (electronic copy only)
Chris Militscher, Environmental Protection Agency (electronic copy only)
Travis Wilson, NC Wildlife Resources Commission (electronic copy only)
Jason Elliott, NCDOT, Roadside Environmental Unit (electronic copy only)
Beth Harmon, Ecosystem Enhancement Program (electronic copy only)
DWR Winston Salem Regional Office (electronic copy only)
File Copy

Transportation and Permitting Unit
1650 Mail Service Center, Raleigh, North Carolina 27699-1650
Location: 512 N. Salisbury St. Raleigh, North Carolina 27604
Phone: 919-807-6300 \ FAX: 919-807-6488
Internet: www.ncwaterquality.org

An Equal Opportunity \ Affirmative Action Employer

One
North Carolina
Naturally

**401 Water Quality Certification Pursuant to Section 401 of the Federal Clean Water Act with
ADDITIONAL CONDITIONS**

THIS CERTIFICATION is issued in conformity with the requirements of Section 401 Public Laws 92-500 and 95-217 of the United States and subject to the North Carolina Division of Water Quality (NCDWQ) Regulations in 15 NCAC 2H .0500. This certification authorizes the NCDOT to impact 3.33 acres of jurisdictional wetlands for the R-2413A project and 2.15 acres of jurisdictional wetlands for the R-2413B project in Guilford County. There will also be impacts to 10045 linear feet of jurisdictional streams for the R-2413A project and 4016 linear feet of jurisdictional streams for the R-2413B project in Guilford County. The project shall be constructed pursuant to the application dated received May 17, 2013 with additional information dated received July 19, 2013, and August 23, 2013. The authorized impacts are as described below:

Stream Impacts in the Cape Fear River Basin for R-2413A

7C (S49)	31	0	31	0
8A (S46)	675	50	725	675
8B (S47)	50	0	50	0
8C (S45)	34	0	34	0
10A (S40)	446	41	487	446
10B (S42)	49	0	49	0
10C (S41)	116	0	116	0
11 (S39A)	47	17	64	0
12A (S37A)	299	0	299	299
12B (S37C)	131	0	131	0
13A (S35)	525	10	535	525
13B (S36)	106	0	106	0
14A (S31)	576	20	596	576
14B (S32)	258	10	268	258
15A (S29A)	533	41	574	533
15B (S30)	46	0	46	0
16A (S27)	362	29	391	362
16B (S28)	33	0	33	0
18 (S25)	0	172	172	0
19 (S23B)	507	34	541	507
20 (S34)	240	0	240	240
21A (S22A/B/S22B)	288	262	550	288
21B (S22.5)	149	0	149	0
22 (S62)	276	22	298	276
23 (S23A)	0	12	12	0
TOTAL	9093	952	10045	8171

Total Stream Impact for R-2413A Project: 10045 linear feet

Stream Impacts in the Cape Fear River Basin for R-2413B

Site	Permanent Fill in Intermittent Stream (linear ft)	Temporary Fill in Intermittent Stream (linear ft)	Permanent Fill in Perennial Stream (linear ft)	Temporary Fill in Perennial Stream (linear ft)	Total Stream Impact (linear ft)	Stream Impacts Requiring Mitigation (linear ft)
1 (S22)			284	45	329	284
2 (S17)			246	15	261	246
3 (S13)			726	30	756	726
4 (S12)	50	15			65	0
5 (S10)			565	24	589	565
5A (S11)			146	17	163	0
6 (S9B)			0	21	21	0
7 (S6A)			411	30	441	411
8 (S3A)			645	0	645	645
8d (S3A)			464	0	464	464
8e (S5)			29	0	29	0
8g (S3a)			253	0	253	253
TOTAL	50	15	3769	182	4016	3594

Total Stream Impact for R-2413B Project: 4016 linear feet

Wetland Impacts in the Cape Fear River Basin for R-2413A

Site (wetland no.)	Fill (ac)	Fill (temporary) (ac)	Excavation (ac)	Mechanized Clearing (ac)	Hand Clearing (ac)	Total Wetland Impact (ac)	Impacts Requiring Mitigation (ac)
1 (W40)	0.01					0.01	0.01
4 (W35)	0.24			0.02		0.26	0.26
6 (W34)	0.01					0.01	0.01
10A (W28)	0.01		0.01			0.02	0.02
10C (W27)	0.01			0.01		0.02	0.02
11 (W25)	0.12					0.12	0.12
15A (W19)	0.01					0.01	0.01
16A (W18)	0.15					0.15	0.15
17 (W17)	0.35			0.03		0.38	0.38
20 (W22)	0.11					0.11	0.11
21A (W14A)	2.11			0.13		2.24	2.24
Total	3.13	0.00	0.01	0.19	0.00	3.33	3.33

Total Wetland Impact for R-2413A Project: 3.33 acres.

Wetland Impacts in the Cape Fear River Basin for R-2413B

Site	Fill (ac)	Fill (temporary) (ac)	Excavation (ac)	Mechanized Clearing (ac)	Hand Clearing (ac)	Total Wetland Impact (ac)	Impacts Requiring Mitigation (ac)
1 (W14)	1.87			0.23		2.10	2.10
8A (W7)	0.02					0.02	0.02
8B (W6)	0.03					0.03	0.03
Total	1.92	0.00	0.00	0.23	0.00	2.15	2.15

Total Wetland Impact for R-2413B Project: 2.15 acres.

The application provides adequate assurance that the discharge of fill material into the waters of the Cape Fear River Basin in conjunction with the proposed development will not result in a violation of applicable Water Quality Standards and discharge guidelines. Therefore, the State of North Carolina certifies that this activity will not violate the applicable portions of Sections 301, 302, 303, 306, 307 of PL 92-500 and PL 95-217 if conducted in accordance with the application and conditions hereinafter set forth.

This approval is only valid for the purpose and design that you submitted in your application dated received May 17, 2013 with additional information dated received July 19, 2013, and August 23, 2013. Should your project change, you are required to notify the NCDWR and submit a new application. If the property is sold, the new owner must be

given a copy of this Certification and approval letter, and is thereby responsible for complying with all the conditions. If any additional wetland impacts, or stream impacts, for this project (now or in the future) exceed one acre or 150 linear feet, respectively, additional compensatory mitigation may be required as described in 15A NCAC 2H .0506 (h) (6) and (7). For this approval to remain valid, you are required to comply with all the conditions listed below. In addition, you should obtain all other federal, state or local permits before proceeding with your project including (but not limited to) Sediment and Erosion control, Coastal Stormwater, Non-discharge and Water Supply watershed regulations. This Certification shall expire on the same day as the expiration date of the corresponding Corps of Engineers Permit.

Condition(s) of Certification:

1. Any modifications to this 401 Water Quality Certification that propose additional stream impacts or increased impervious surface requiring additional stormwater management may be subject to the Jordan Water Supply Nutrient Strategy (15A NCAC02B .0267). The NCDOT shall coordinate with the NCDWR prior to submitting a modification request to determine the applicability of the Jordan Water Supply Nutrient Strategy. This condition does not apply to major modifications for additional sections of the project that were covered under the Finding of No Significant Impact or approved in the Avoidance and Minimization stage of the project.
2. The NCDOT Division Environmental Officer or Environmental Assistant will conduct a pre-construction meeting with all appropriate staff to ensure that the project supervisor and essential staff understand the potential issues with stream and pipe alignment at the permitted site. NCDWR staff shall be invited to the pre-construction meeting.
3. Channel relocations shall be completed and stabilized, and approved on site by NCDWR staff, prior to diverting water into the new channel. Stream banks shall be matted with coir-fiber matting. Vegetation used for bank stabilization shall be limited to native riparian vegetation, and should include establishment of a vegetated buffer on both sides of the relocated channel to the maximum extent practical. Also, rip-rap may be allowed if it is necessary to maintain the physical integrity of the stream, but the applicant must provide written justification and any calculations used to determine the extent of rip-rap coverage requested. Once the stream has been turned into the new channel, it may be necessary to relocate stranded fish to the new channel to prevent fish kills.
4. Compensatory mitigation for impacts to 8171 linear feet of streams for the R-2413A project and 3594 for the R-2413B project at a replacement ratio of 1:1 is required. Compensatory mitigation for impacts to jurisdictional streams shall be provided by onsite stream relocations of 2,390 linear feet of stream for the R-2413A project and 765 linear feet of stream for the R-2413B project. The onsite stream relocation shall be constructed in accordance with the design submitted in your application dated received July 19, 2013, and August 23, 2013. All on-site mitigation sites shall be protected in perpetuity by a conservation easement or through NCDOT fee simple acquisition and recorded in the NCDOT Natural Environment Unit mitigation geodatabase. Please be reminded that as-builts for the completed streams shall be submitted to the North Carolina Division of Water Resources 401 Wetlands Unit with the as-builts for the rest of the project. If the parameters of this condition are not met, then the permittee shall supply additional stream mitigation for the 2,390 linear feet of impacts. All channel relocations will be constructed in a dry work area, will be completed and stabilized, and must be approved on site by NCDWR staff, prior to diverting water into the new channel. Whenever possible, channel relocations shall be allowed to stabilize for an entire growing season. All stream relocations shall have a 50-foot wide native wooded buffer planted on both sides of the stream unless otherwise authorized by this Certification. A transitional phase incorporating rolled erosion control product (RECP) and appropriate temporary ground cover is allowable.
5. The stream mitigation site shall be monitored annually for five years or until success criteria are satisfied. Monitoring protocols shall follow the Monitoring Level I outlined in the Stream Mitigation Guidelines, April 2003.
6. Compensatory mitigation for 8171 linear feet of impact to streams for the R-2413A project and 3594 linear feet of impact to streams for the R-2413B project is required. We understand that you have chosen to perform compensatory mitigation for impacts to 5781 linear feet of streams for the R-2413A project and 2829 linear feet of streams for the R-2413B project through the North Carolina Ecosystem Enhancement Program (EEP), and that the EEP has agreed to implement the mitigation for the project. EEP has indicated in a letter dated September 24, 2013 that they will assume responsibility for satisfying the federal Clean Water Act compensatory mitigation requirements for the above-referenced project, in accordance with the EEP Mitigation Banking Instrument signed July 28, 2010.
7. Compensatory mitigation for impacts to 3.33 acres for the R-2413A project and 2.15 acres for the R-2413B project (riparian) wetlands is required. We understand that you have chosen to perform compensatory mitigation for impacts to wetlands through the North Carolina Ecosystem Enhancement Program (EEP), and that the EEP has agreed to implement the mitigation for the project. EEP has indicated in a letter dated

September 24, 2013 that they will assume responsibility for satisfying the federal Clean Water Act compensatory mitigation requirements for the above-referenced project, in accordance with EEP's Mitigation Banking Instrument signed July 28, 2010.

8. At locations where ponds will be drained, proper measures will be taken to drain the pond with limited impact to upstream and downstream channel stability as well as to native aquatic species. Proper measures will be taken to avoid sediment release and/or sediment accumulation downstream as a result of pond draining. If typical pond draining techniques will create significant disturbance to native aquatic species, additional measures such as collection and relocation may be necessary to prevent a significant fish kill. NCDOT shall consult with NC Wildlife Resources staff to determine if there are any sensitive species, and the most appropriate measures to limit impacts to these species. The permittee shall observe any natural channel re-establishment, or utilize natural channel construction techniques, to ensure that the jurisdictional stream channel above and below the drained pond remain stable, and that no additional impacts occur within the natural stream channel as a result of draining the pond.
9. The post-construction removal of any temporary bridge structures must return the project site to its preconstruction contours and elevations. The impacted areas shall be revegetated with appropriate native species.
10. Bridge deck drains shall not discharge directly into the stream. Stormwater shall be directed across the bridge and pre-treated through site-appropriate means (grassed swales, pre-formed scour holes, vegetated buffers, etc.) before entering the stream. Please refer to the most current version of *Stormwater Best Management Practices*.
11. Bridge piles and bents shall be constructed using driven piles (hammer or vibratory) or drilled shaft construction methods. More specifically, jetting or other methods of pile driving are prohibited without prior written approval from the NCDWR first.
12. No drill slurry or water that has been in contact with uncured concrete shall be allowed to enter surface waters. This water shall be captured, treated, and disposed of properly.
13. All bridge construction shall be performed from the existing bridge, temporary work bridges, temporary causeways, or floating or sunken barges. If work conditions require barges, they shall be floated into position and then sunk. The barges shall not be sunk and then dragged into position. Under no circumstances should barges be dragged along the bottom of the surface water.
14. If multiple pipes or barrels are required, they shall be designed to mimic natural stream cross section as closely as possible including pipes or barrels at flood plain elevation and/or sills where appropriate. Widening the stream channel should be avoided. Stream channel widening at the inlet or outlet end of structures typically decreases water velocity causing sediment deposition that requires increased maintenance and disrupts aquatic life passage.
15. Riprap shall not be placed in the active thalweg channel or placed in the streambed in a manner that precludes aquatic life passage. Bioengineering boulders or structures should be properly designed, sized and installed.
16. For the 1,149 linear feet of streams being impacted due to site dewatering activities, the site shall be graded to its preconstruction contours and revegetated with appropriate native species.
17. The stream channel shall be excavated no deeper than the natural bed material of the stream, to the maximum extent practicable. Efforts must be made to minimize impacts to the stream banks, as well as to vegetation responsible for maintaining the stream bank stability. Any applicable riparian buffer impact for access to stream channel shall be temporary and be revegetated with native riparian species.
18. Pipes and culverts used exclusively to maintain equilibrium in wetlands, where aquatic life passage is not a concern, shall not be buried. These pipes shall be installed at natural ground elevation.
19. All portions of the proposed project draining to 303(d) listed watersheds that are impaired due to biological criteria exceedances shall not discharge stormwater directly to surface waters. Stormwater shall be treated using appropriate best management practices (e.g., vegetated conveyances, constructed wetlands, detention ponds, etc.) prior to discharging to surface waters.
20. Unless otherwise approved in this certification, placement of culverts and other structures in open waters and streams shall be placed below the elevation of the streambed by one foot for all culverts with a diameter greater than 48 inches, and 20 percent of the culvert diameter for culverts having a diameter less than 48 inches, to allow low flow passage of water and aquatic life. Design and placement of culverts and other structures including temporary erosion control measures shall not be conducted in a manner that may result in dis-equilibrium of wetlands or streambeds or banks, adjacent to or upstream and down stream of the above structures. The applicant is required to provide evidence that the equilibrium is being maintained if requested in writing by NCDWR. If this condition is unable to be met due to bedrock or other limiting features encountered during construction, please contact NCDWR for guidance on how to proceed and to determine whether or not a permit modification will be required.

21. If concrete is used during construction, a dry work area shall be maintained to prevent direct contact between curing concrete and stream water. Water that inadvertently contacts uncured concrete shall not be discharged to surface waters due to the potential for elevated pH and possible aquatic life and fish kills.
22. During the construction of the project, no staging of equipment of any kind is permitted in waters of the U.S., or protected riparian buffers.
23. The dimension, pattern and profile of the stream above and below the crossing shall not be modified. Disturbed floodplains and streams shall be restored to natural geomorphic conditions.
24. The use of rip-rap above the Normal High Water Mark shall be minimized. Any rip-rap placed for stream stabilization shall be placed in stream channels in such a manner that it does not impede aquatic life passage.
25. The Permittee shall ensure that the final design drawings adhere to the permit and to the permit drawings submitted for approval.
26. Prior to commencing ground disturbing activities, an acceptable monitoring and mitigation plan for the presence of sulfide-bearing rock must be approved by the NCDWR.
27. All work in or adjacent to stream waters shall be conducted in a dry work area. Approved BMP measures from the most current version of NCDOT Construction and Maintenance Activities manual such as sandbags, rock berms, cofferdams and other diversion structures shall be used to prevent excavation in flowing water.
28. Heavy equipment shall be operated from the banks rather than in the stream channel in order to minimize sedimentation and reduce the introduction of other pollutants into the stream.
29. All mechanized equipment operated near surface waters must be regularly inspected and maintained to prevent contamination of stream waters from fuels, lubricants, hydraulic fluids, or other toxic materials.
30. No rock, sand or other materials shall be dredged from the stream channel except where authorized by this certification.
31. Discharging hydroseed mixtures and washing out hydroseeders and other equipment in or adjacent to surface waters is prohibited.
32. The permittee and its authorized agents shall conduct its activities in a manner consistent with State water quality standards (including any requirements resulting from compliance with §303(d) of the Clean Water Act) and any other appropriate requirements of State and Federal law. If the NCDWR determines that such standards or laws are not being met (including the failure to sustain a designated or achieved use) or that State or federal law is being violated, or that further conditions are necessary to assure compliance, the NCDWR may reevaluate and modify this certification.
33. All fill slopes located in jurisdictional wetlands shall be placed at slopes no flatter than 3:1, unless otherwise authorized by this certification..
34. A copy of this Water Quality Certification shall be maintained on the construction site at all times. In addition, the Water Quality Certification and all subsequent modifications, if any, shall be maintained with the Division Engineer and the on-site project manager.
35. The outside buffer, wetland or water boundary located within the construction corridor approved by this authorization shall be clearly marked by highly visible fencing prior to any land disturbing activities. Impacts to areas within the fencing are prohibited unless otherwise authorized by this certification.
36. The issuance of this certification does not exempt the Permittee from complying with any and all statutes, rules, regulations, or ordinances that may be imposed by other government agencies (i.e. local, state, and federal) having jurisdiction, including but not limited to applicable buffer rules, stormwater management rules, soil erosion and sedimentation control requirements, etc.
37. The Permittee shall report any violations of this certification to the Division of Water Resources within 24 hours of discovery.
38. Upon completion of the project (including any impacts at associated borrow or waste sites), the NCDOT Division Engineer shall complete and return the enclosed "Certification of Completion Form" to notify NCDWR when all work included in the 401 Certification has been completed.
39. Native riparian vegetation must be reestablished in the riparian areas within the construction limits of the project by the end of the growing season following completion of construction.
40. There shall be no excavation from, or waste disposal into, jurisdictional wetlands or waters associated with this permit without appropriate modification. Should waste or borrow sites, or access roads to waste or borrow sites, be located in wetlands or streams, compensatory mitigation will be required since that is a direct impact from road construction activities.
41. Sediment and erosion control measures shall not be placed in wetlands or waters unless otherwise approved by this Certification.
42. Erosion and sediment control practices must be in full compliance with all specifications governing the proper design, installation and operation and maintenance of such Best Management Practices in order to protect surface waters standards:

- a. The erosion and sediment control measures for the project must be designed, installed, operated, and maintained in accordance with the most recent version of the *North Carolina Sediment and Erosion Control Planning and Design Manual*.
- b. The design, installation, operation, and maintenance of the sediment and erosion control measures must be such that they equal, or exceed, the requirements specified in the most recent version of the *North Carolina Sediment and Erosion Control Manual*. The devices shall be maintained on all construction sites, borrow sites, and waste pile (spoil) projects, including contractor-owned or leased borrow pits associated with the project.
- c. For borrow pit sites, the erosion and sediment control measures must be designed, installed, operated, and maintained in accordance with the most recent version of the *North Carolina Surface Mining Manual*.
- d. The reclamation measures and implementation must comply with the reclamation in accordance with the requirements of the Sedimentation Pollution Control Act

Violations of any condition herein set forth may result in revocation of this Certification and may result in criminal and/or civil penalties. This Certification shall become null and void unless the above conditions are made conditions of the Federal 404 and/or Coastal Area Management Act Permit. This Certification shall expire upon the expiration of the 404 or CAMA permit.

If you wish to contest any statement in the attached Certification you must file a petition for an administrative hearing. You may obtain the petition form from the office of Administrative hearings. You must file the petition with the office of Administrative Hearings within sixty (60) days of receipt of this notice. A petition is considered filed when it is received in the office of Administrative Hearings during normal office hours. The Office of Administrative Hearings accepts filings Monday through Friday between the hours of 8:00am and 5:00pm, except for official state holidays. The original and one (1) copy of the petition must be filed with the Office of Administrative Hearings.

The petition may be faxed-provided the original and one copy of the document is received by the Office of Administrative Hearings within five (5) business days following the faxed transmission. The mailing address for the Office of Administrative Hearings is:

Office of Administrative Hearings
6714 Mail Service Center
Raleigh, NC 27699-6714
Telephone: (919)-431-3000, Facsimile: (919)-431-3100

A copy of the petition must also be served on DENR as follows:

Mr. Lacy Presnell, General Counsel
Department of Environment and Natural Resources
1601 Mail Service Center

This the 28th day of October 2013

DIVISION OF WATER RESOURCES

Thomas A. Reeder

WQC No. 3971



North Carolina Department of Environment and Natural Resources

Division of Water Resources

Water Quality Programs

Thomas A. Reeder

Director

Pat McCrory
Governor

John E. Skvarla, III
Secretary

NCDWR Project No.: 2013-0517

County: _Guilford

Applicant: ___ NCDOT _____

Project Name: ___ R2413A&B _____

Date of Issuance of 401 Water Quality Certification: ___ October 11, 2013 _____

Certificate of Completion

Upon completion of all work approved within the 401 Water Quality Certification or applicable Buffer Rules, and any subsequent modifications, the applicant is required to return this certificate to the 401 Transportation Permitting Unit, North Carolina Division of Water Resources, 1650 Mail Service Center, Raleigh, NC, 27699-1650. This form may be returned to NCDWR by the applicant, the applicant's authorized agent, or the project engineer. It is not necessary to send certificates from all of these.

Applicant's Certification

I, _____, hereby state that, to the best of my abilities, due care and diligence was used in the observation of the construction such that the construction was observed to be built within substantial compliance and intent of the 401 Water Quality Certification and Buffer Rules, the approved plans and specifications, and other supporting materials.

Signature: _____ Date: _____

Agent's Certification

I, _____, hereby state that, to the best of my abilities, due care and diligence was used in the observation of the construction such that the construction was observed to be built within substantial compliance and intent of the 401 Water Quality Certification and Buffer Rules, the approved plans and specifications, and other supporting materials.

Signature: _____ Date: _____

Engineer's Certification

_____ Partial _____ Final

I, _____, as a duly registered Professional Engineer in the State of North Carolina, having been authorized to observe (periodically, weekly, full time) the construction of the project, for the Permittee hereby state that, to the best of my abilities, due care and diligence was used in the observation of the construction such that the construction was observed to be built within substantial compliance and intent of the 401 Water Quality Certification and Buffer Rules, the approved plans and specifications, and other supporting materials.

Signature _____ Registration No. _____

Date _____

Transportation and Permitting Unit
1650 Mail Service Center, Raleigh, North Carolina 27699-1650
Location: 512 N. Salisbury St. Raleigh, North Carolina 27604
Phone: 919-807-6300 \ FAX: 919-807-6488
Internet: www.ncwaterquality.org



STATE OF NORTH CAROLINA
DIVISION OF HIGHWAYS
GUILFORD COUNTY

LOCATION: NC 68 CONNECTOR - FROM FOUR LANES AT SR 2011
(EDGEFIELD ROAD) TO SR 2127 (BROOKBANK ROAD)

TYPE OF WORK: GRADING, PAVING, WIDENING, RESURFACING,
DRAINAGE, STRUCTURES, SIGNING, SIGNALS, AND ITS

WETLAND & STREAM IMPACTS

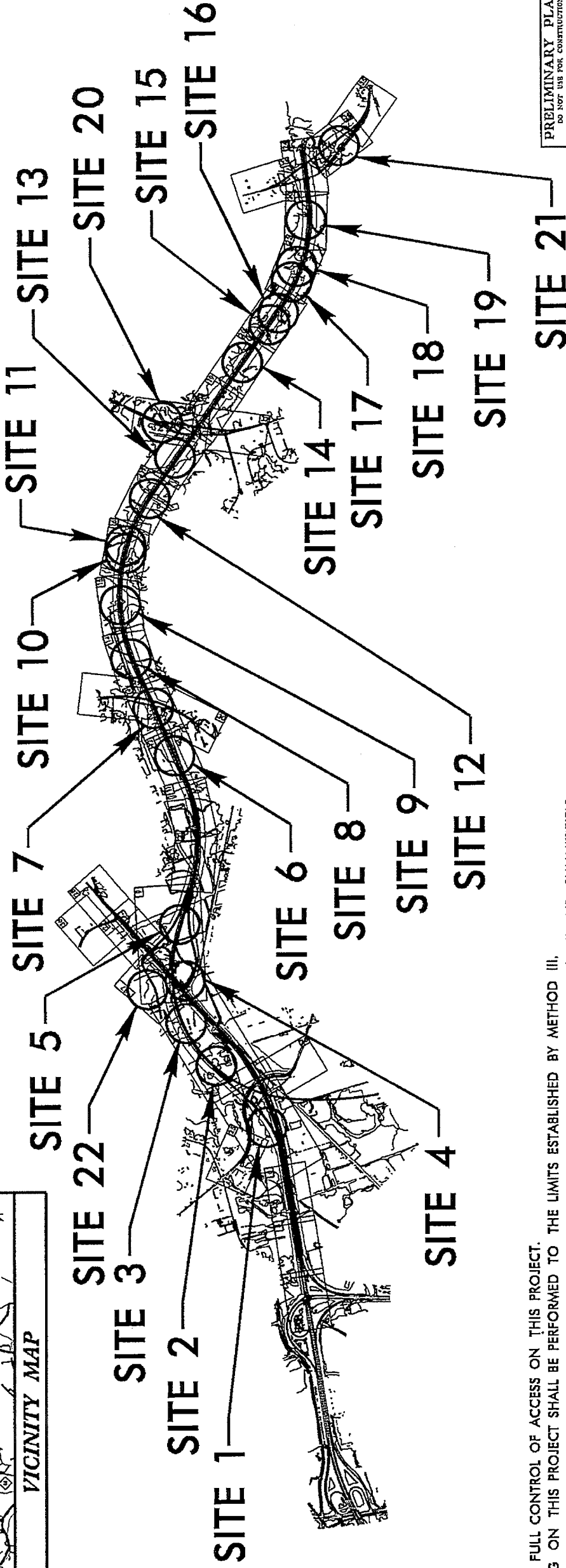

THERE IS FULL CONTROL OF ACCESS ON THIS PROJECT.
CLEARING ON THIS PROJECT SHALL BE PERFORMED TO THE LIMITS ESTABLISHED BY METHOD III.
A PORTION OF THIS PROJECT IS WITHIN THE MUNICIPAL BOUNDARIES OF GREENSBORO, OAK RIDGE, AND SUMMERFIELD.

CONTRACT:

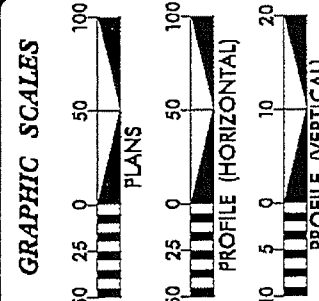

DESIGN DATA

ADT 2012	=	23,000
ADT 2035	=	40,800
DHV	=	11 %
D	=	70 %
T	=	15 % *
V	=	70 MPH
* TTST 10% DUAL 5%		
FUNC CLASS - INTERSTATE		

PROJECT LENGTH

LENGTH ROADWAY TIP PROJECT R-2413A	=	4.803 MILES
LENGTH STRUCTURE TIP PROJECT R-2413A	=	0.150 MILES
TOTAL LENGTH TIP PROJECT R-2413A	=	4.953 MILES

Prepared in the Office of:
DIVISION OF HIGHWAYS
1000 Birch Ridge Dr., Raleigh NC, 27610

2006 STANDARD SPECIFICATIONS

RIGHT OF WAY DATE:	NOVEMBER 18, 2011
LETTING DATE:	APRIL 15, 2014

HYDRAULICS ENGINEER	ROADWAY DESIGN ENGINEER
SIGNATURE: _____	SIGNATURE: _____

STATE OF NORTH CAROLINA
DIVISION OF HIGHWAYS
STATE OF NORTH CAROLINA

STATE HIGHWAY DESIGN ENGINEER

PRELIMINARY PLANS
DO NOT USE FOR CONSTRUCTION

STATE	N.C.	STATE PROJECT REFERENCE NO.	R-2413A	SHEET NO.	1	TOTAL SHEETS	1
STATE	N.C.	STATE PROJECT REFERENCE NO.	R-2413A	DESCRIPTION	PE		
STATE	N.C.	STATE PROJECT REFERENCE NO.	R-2413A	DESCRIPTION	RV, UTIL		

Permit Drawing
Sheet 1 of 8

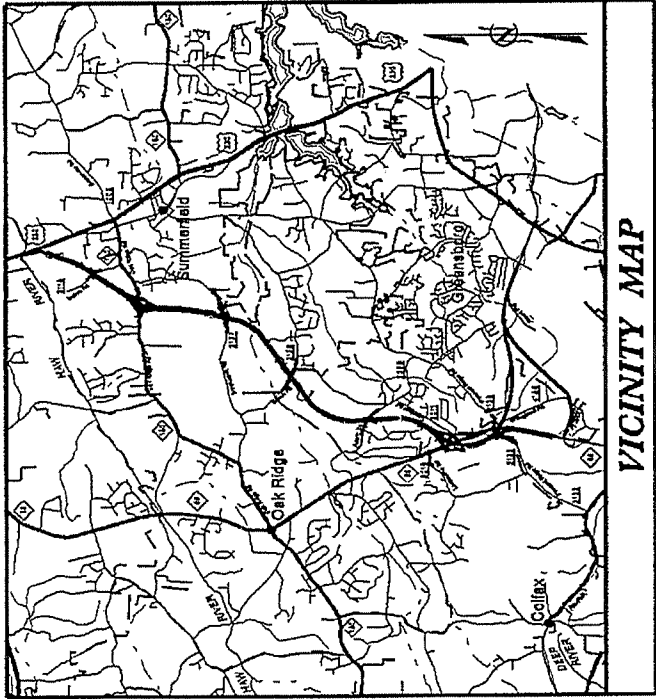
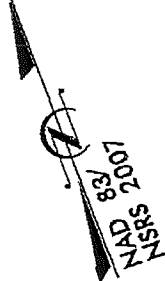

TIP PROJECT: R-2413A

PROJECT REFERENCE NO.	R-2413A	SHEET NO.	7
BY SHEET NO.	ROADWAY DESIGN ENGINEER	HYDRAULICS ENGINEER	
PRELIMINARY PLANS DO NOT USE FOR CONSTRUCTION			

Permit Drawing
Sheet 2 of 81
NAD 83/NSRS 2007

REVISIONS

BY REVISION: PROPERTY OWNER NAME AND DEED BOOK INFORMATION HAVE BEEN CORRECTED ON PARCELS 5 AND 6. ITR 5-21-17

BY REVISION: PROPERTY OWNER NAME AND DEED BOOK INFORMATION HAS BEEN CHANGED ON PARCEL 1. CEH 2/27/13.

SITE 1

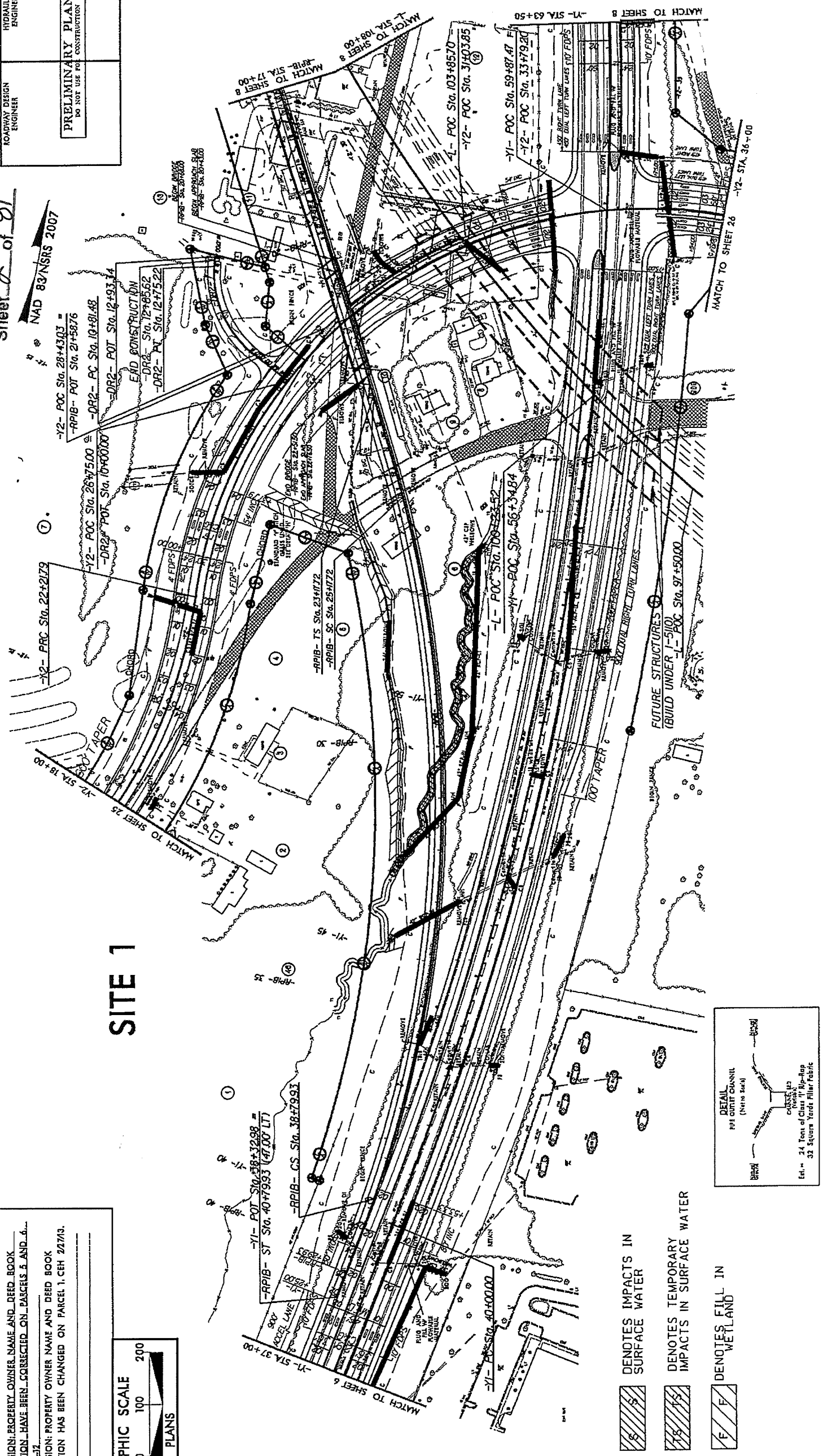
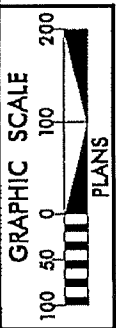

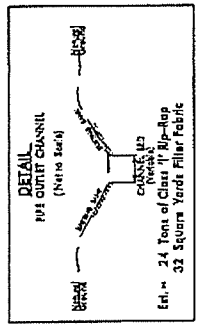

- DENOTES IMPACTS IN SURFACE WATER
- DENOTES TEMPORARY IMPACTS IN SURFACE WATER
- DENOTES FILL IN WETLAND



PROJECT REFERENCE NO. R-243A	SHEET NO. 7
HWY. SHEET NO. ROADWAY DESIGN ENGINEER	HYDRAULICS ENGINEER
PRELIMINARY PLANS DO NOT USE FOR CONSTRUCTION	

Permit Drawing
Sheet 4 of 8
NAD 83/NSRS 2007

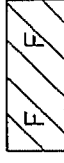
-  DENOTES IMPACTS IN SURFACE WATER
-  DENOTES TEMPORARY IMPACTS IN SURFACE WATER
-  DENOTES FILL IN WETLAND

SITE 1

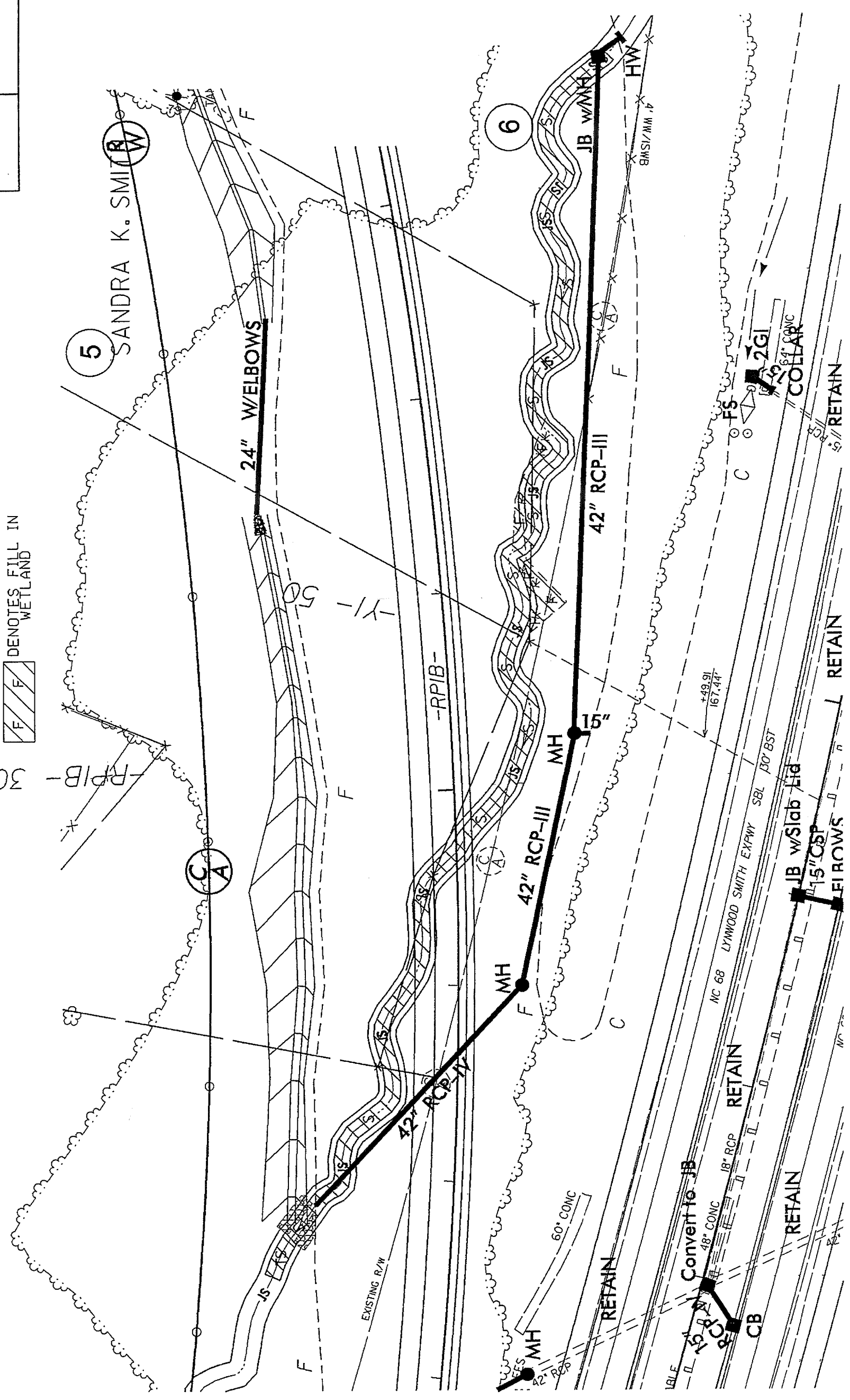
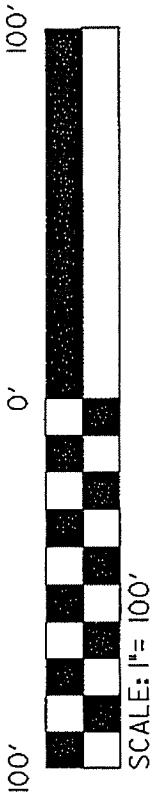

5 SANDRA K. SMITH

6

Convert to JB
48" CONC
18" RCP
RETAIN

RETAIN

RETAIN

RETAIN

RETAIN

RETAIN

RETAIN

REVISIONS

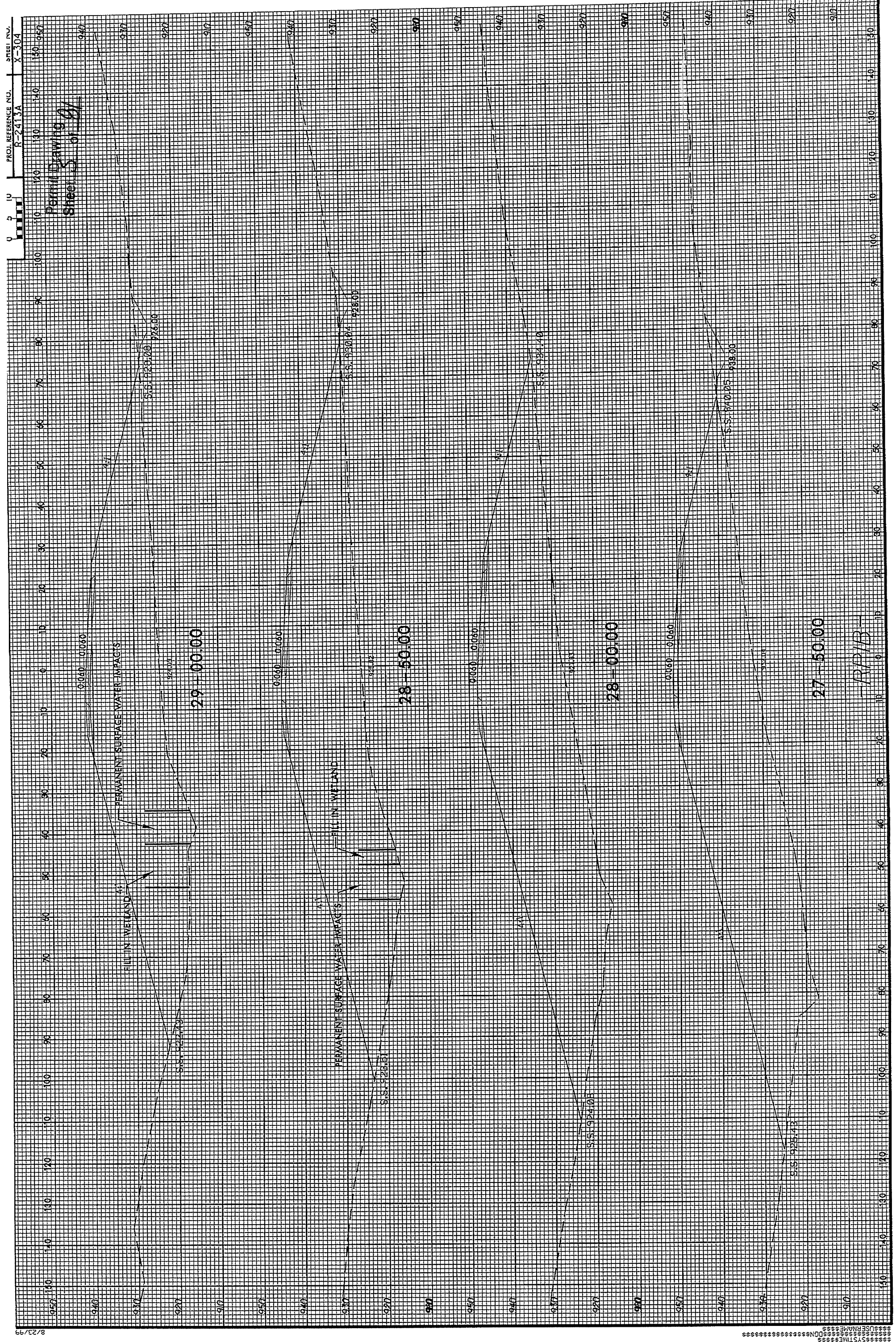

 SYSTEMNAME

 USERNAME

PROJECT REFERENCE NO. R-2413A	SHEET NO. 8
BY SHEET NO. ROADWAY DESIGN ENGINEER	HYDRAULICS ENGINEER
PRELIMINARY PLANS DO NOT USE FOR CONSTRUCTION	

NAD 83/NSRS 2007
SITE 3
 (CONTINUED ON SHEET 37)

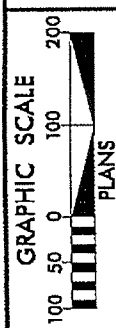
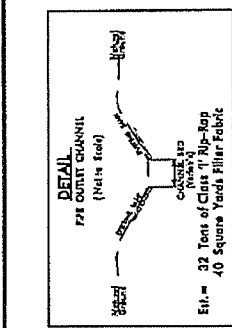
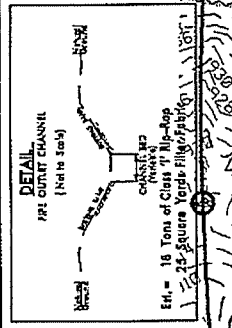

SITE 2

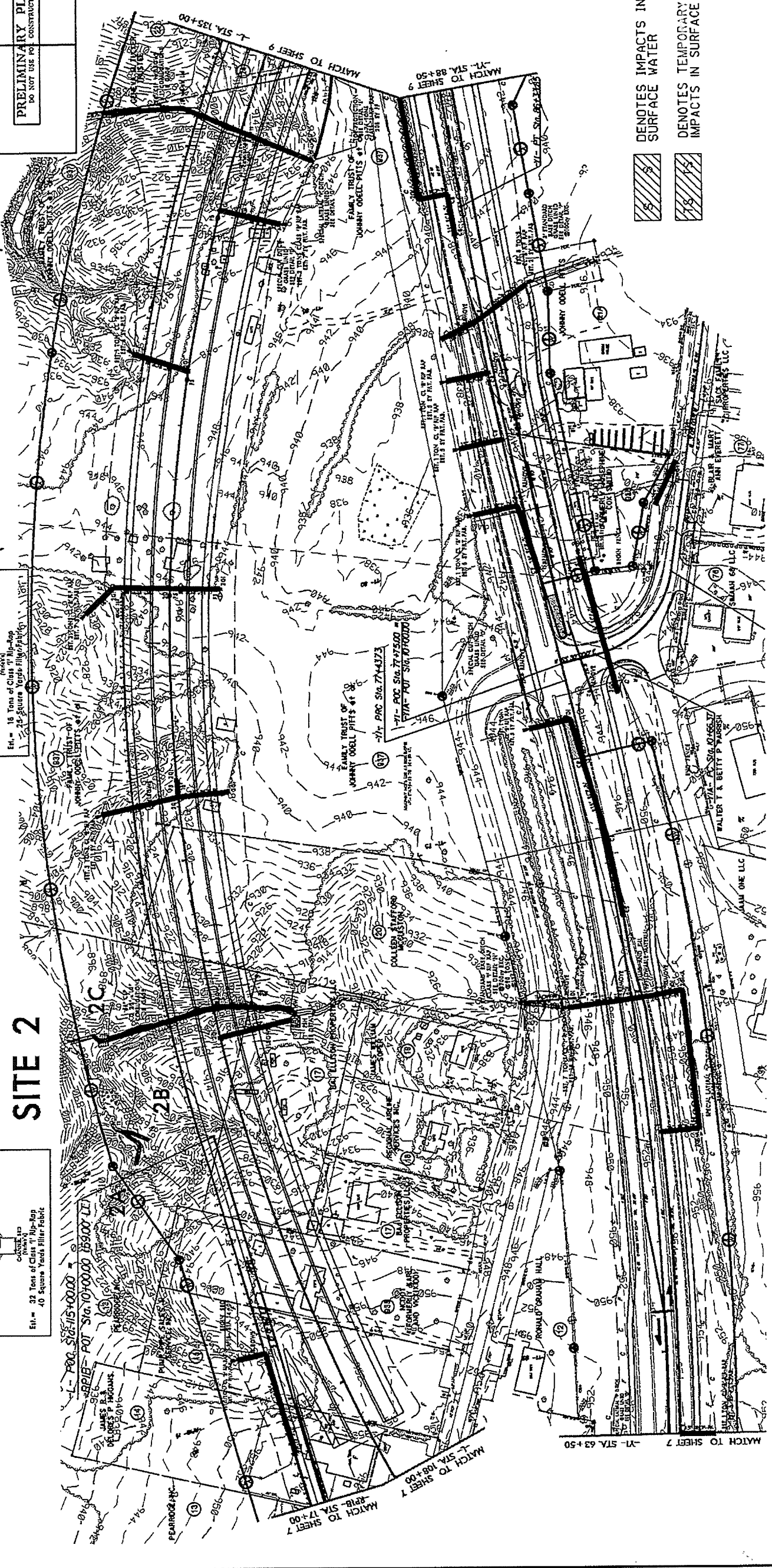

DENOTES IMPACTS IN SURFACE WATER
 DENOTES TEMPORARY IMPACTS IN SURFACE WATER

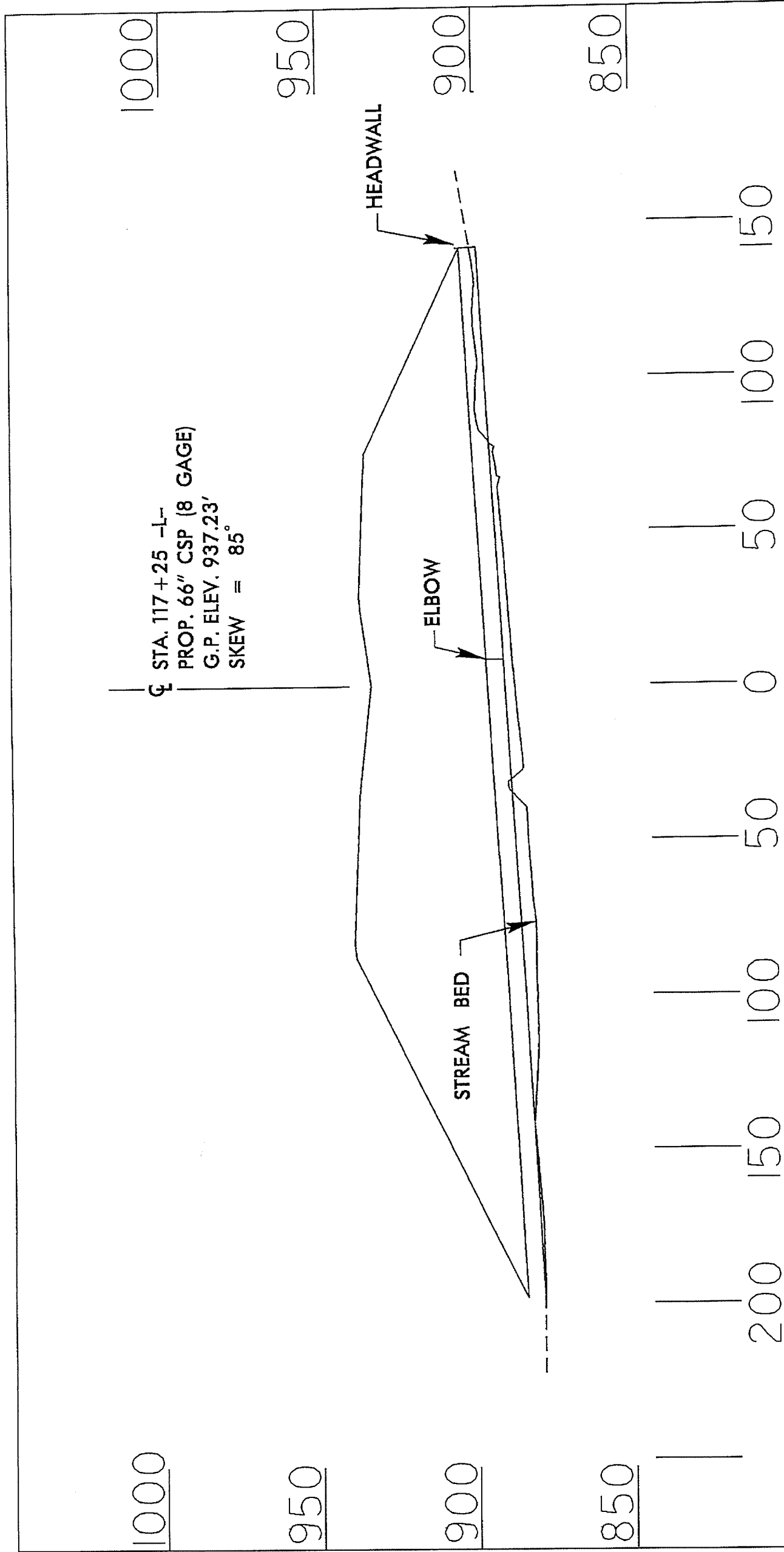

PROFILE

NCDOT
 DIVISION OF HIGHWAYS
 GUILFORD COUNTY
 PROJECT: 34429.1.1 (R-2413A)
 NC 68 CONNECTOR
 FROM FOUR LANES AT
 SR 2011 TO SR 2127

PROJECT REFERENCE NO. R-243A	STREET NO. 8
HWY. SHEET NO. ROADWAY DESIGN ENGINEER	HYDRAULICS ENGINEER

PRELIMINARY PLANS
DO NOT USE FOR CONSTRUCTION

Permit Drawing
Sheet 7 of 81

MAD 887NRS 2007

- DENOTES IMPACTS IN SURFACE WATER
- DENOTES TEMPORARY IMPACTS IN SURFACE WATER

SITE 2

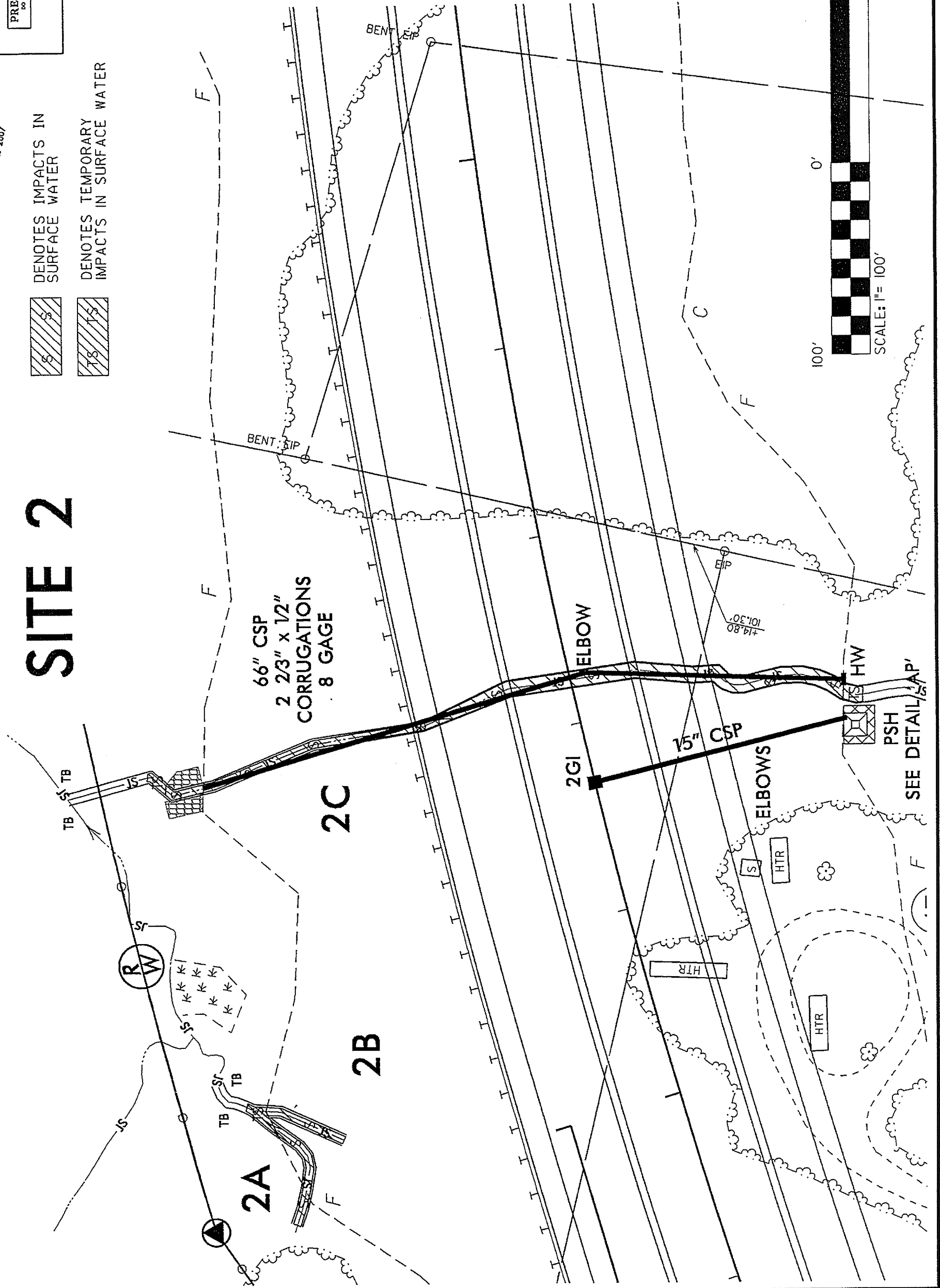

8/17/99 SYSTEMTIME:***** DGN:***** PLOT:*****

PROJECT REFERENCE NO.	SHEET NO.
R-2413A	9
BY SHEET NO.	HYDRAULICS ENGINEER
ROADWAY DESIGN ENGINEER	
PRELIMINARY PLANS DO NOT USE FOR CONSTRUCTION	

- DENOTES FILL IN WETLAND
- DENOTES IMPACTS IN SURFACE WATER
- DENOTES TEMPORARY IMPACTS IN SURFACE WATER

DETAIL
 PIPE OUTLET CHANNEL
 (Notes Refer)

Est. = 18 Tons of Class 7 Rip-Rap
 24 Square Yards Filter Fabric

DETAIL
 PIPE OUTLET CHANNEL
 (Notes Refer)

Est. = 30 Tons of Class 7 Rip-Rap
 40 Square Yards Filter Fabric

SITE 4
 (CONTINUED ON SHEET 37)

SITE 5

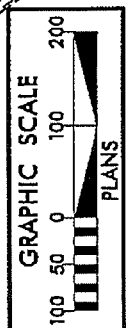
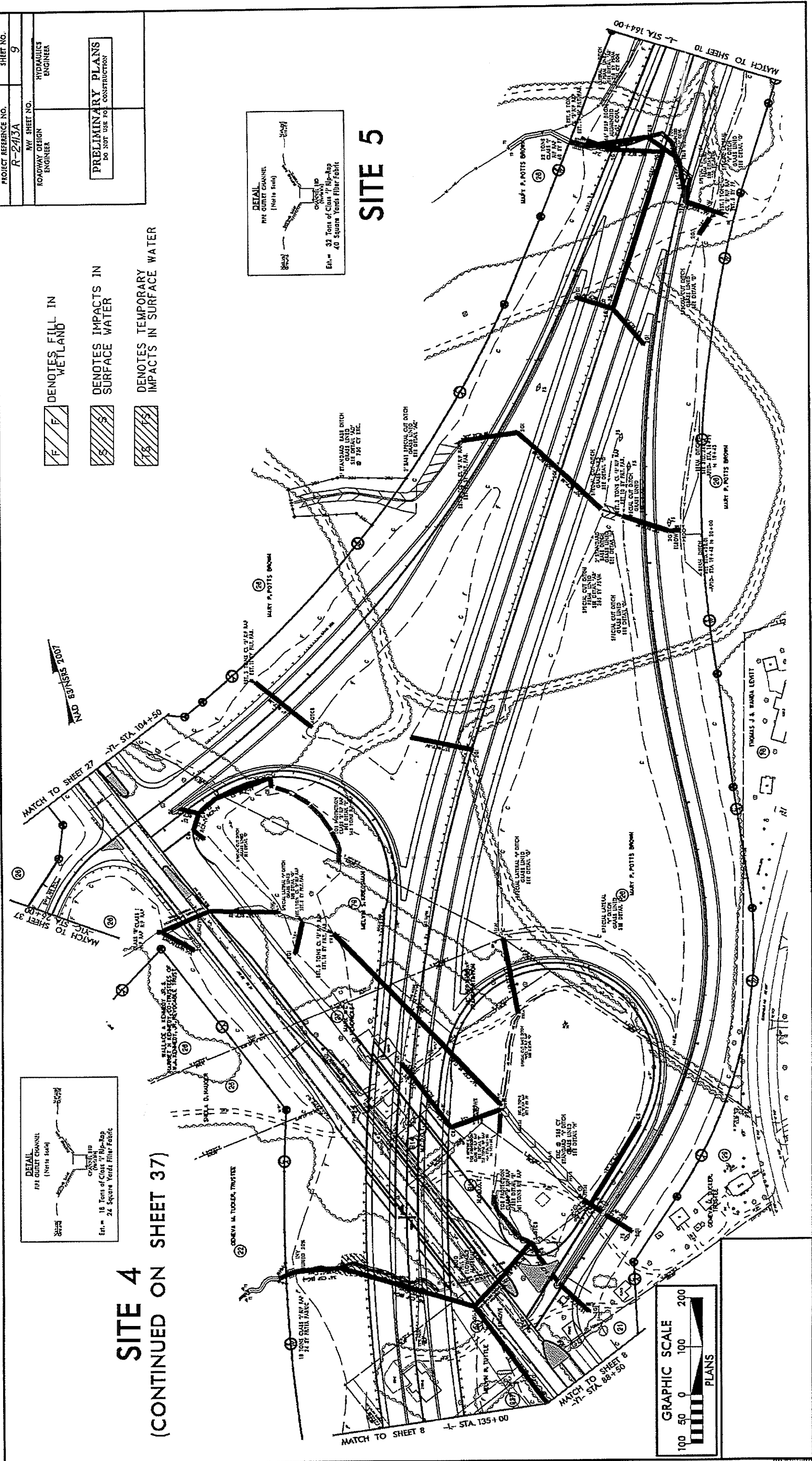

PROJECT REFERENCE NO. R-2413A	SHEET NO. 9
BY SHEET NO. ROADWAY DESIGN ENGINEER	HYDRAULICS ENGINEER
PRELIMINARY PLANS DO NOT USE FOR CONSTRUCTION	

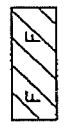
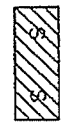
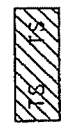
-  DENOTES FILL IN WETLAND
-  DENOTES IMPACTS IN SURFACE WATER
-  DENOTES TEMPORARY IMPACTS IN SURFACE WATER

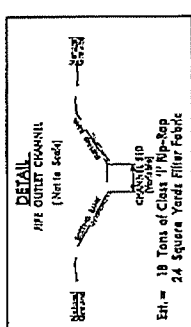

SITE 4
 (CONTINUED ON SHEET 37)

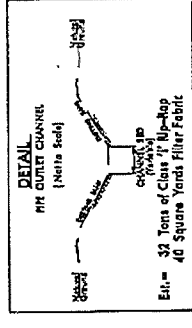

SITE 5

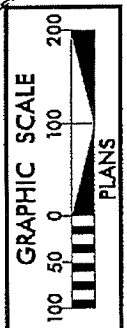
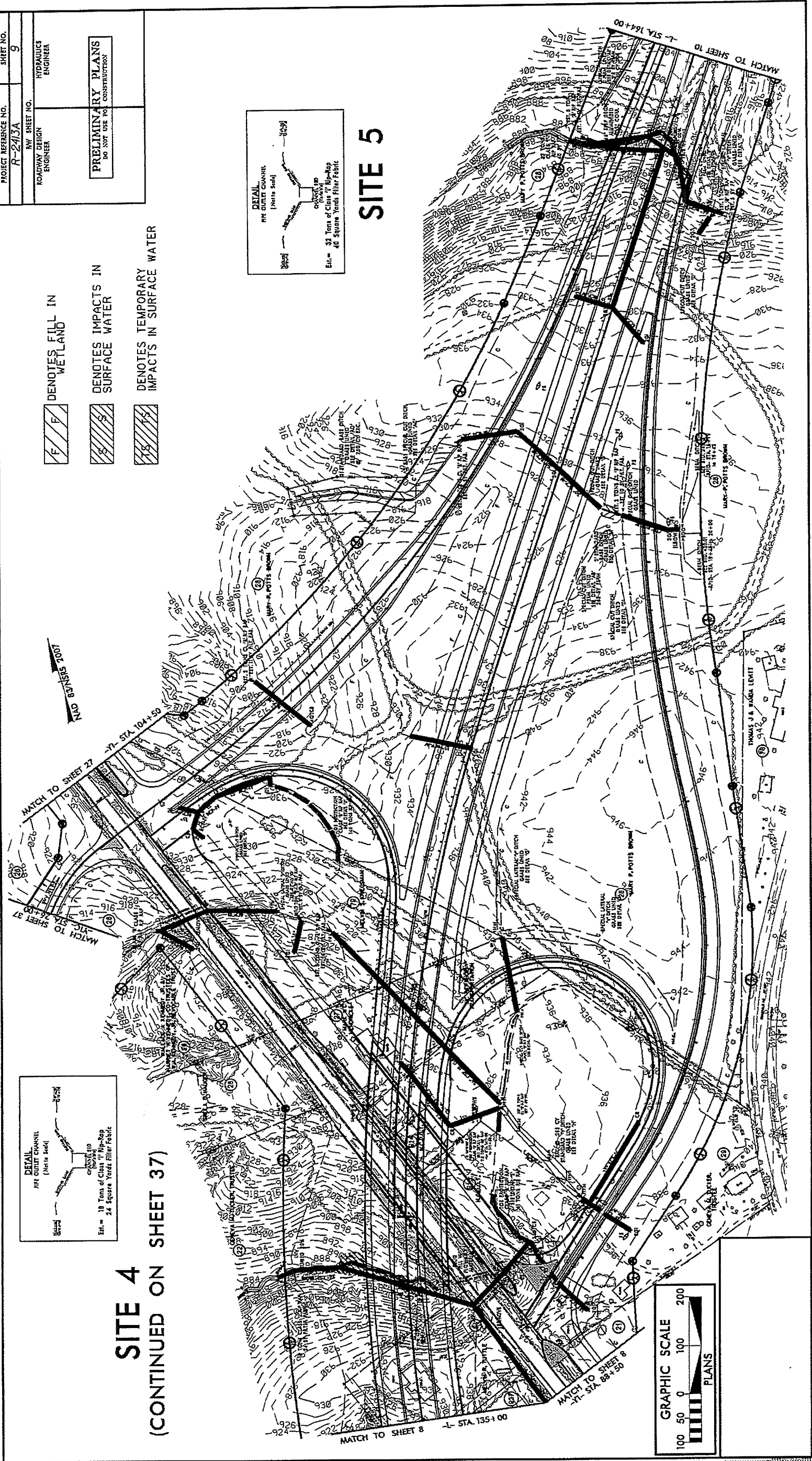

PROJECT REFERENCE NO. R-2413A	SHEET NO. 9
BY: SHEET NO. ROADWAY DESIGN ENGINEER	HYDRAULICS ENGINEER
PRELIMINARY PLANS DO NOT USE FOR CONSTRUCTION	

Permit Drawing
Sheet 13 of 31



SITE 4 (CONTINUED ONTO SHEET 37)

- DENOTES IMPACTS IN SURFACE WATER
- DENOTES TEMPORARY IMPACTS IN SURFACE WATER
- DENOTES FILL IN WETLAND

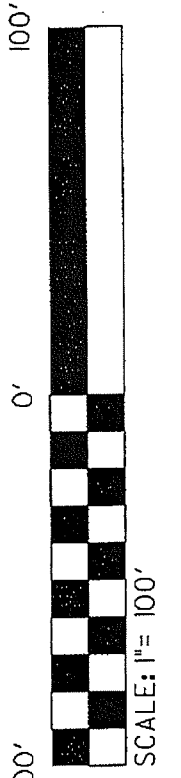
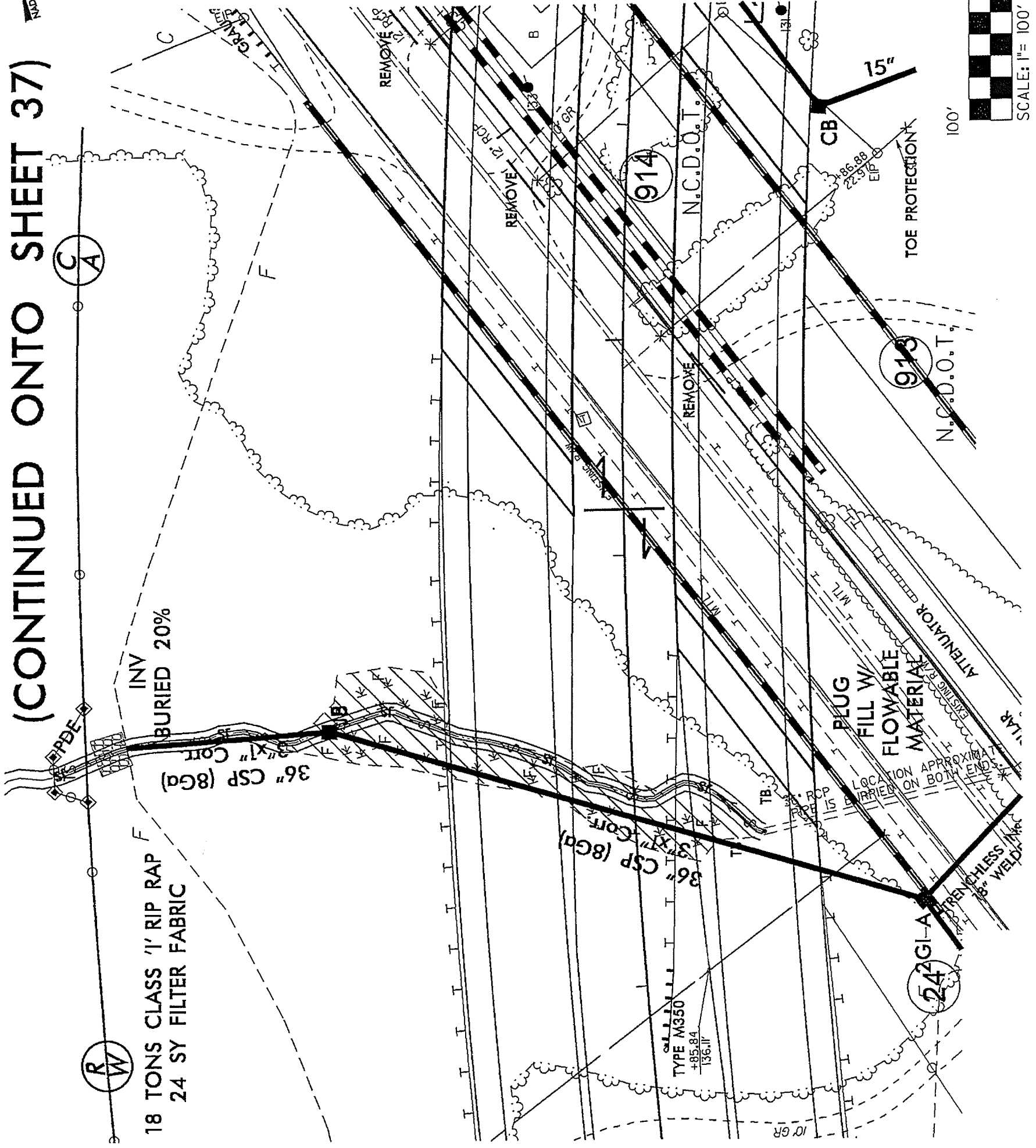

8/17/99

REVISIONS

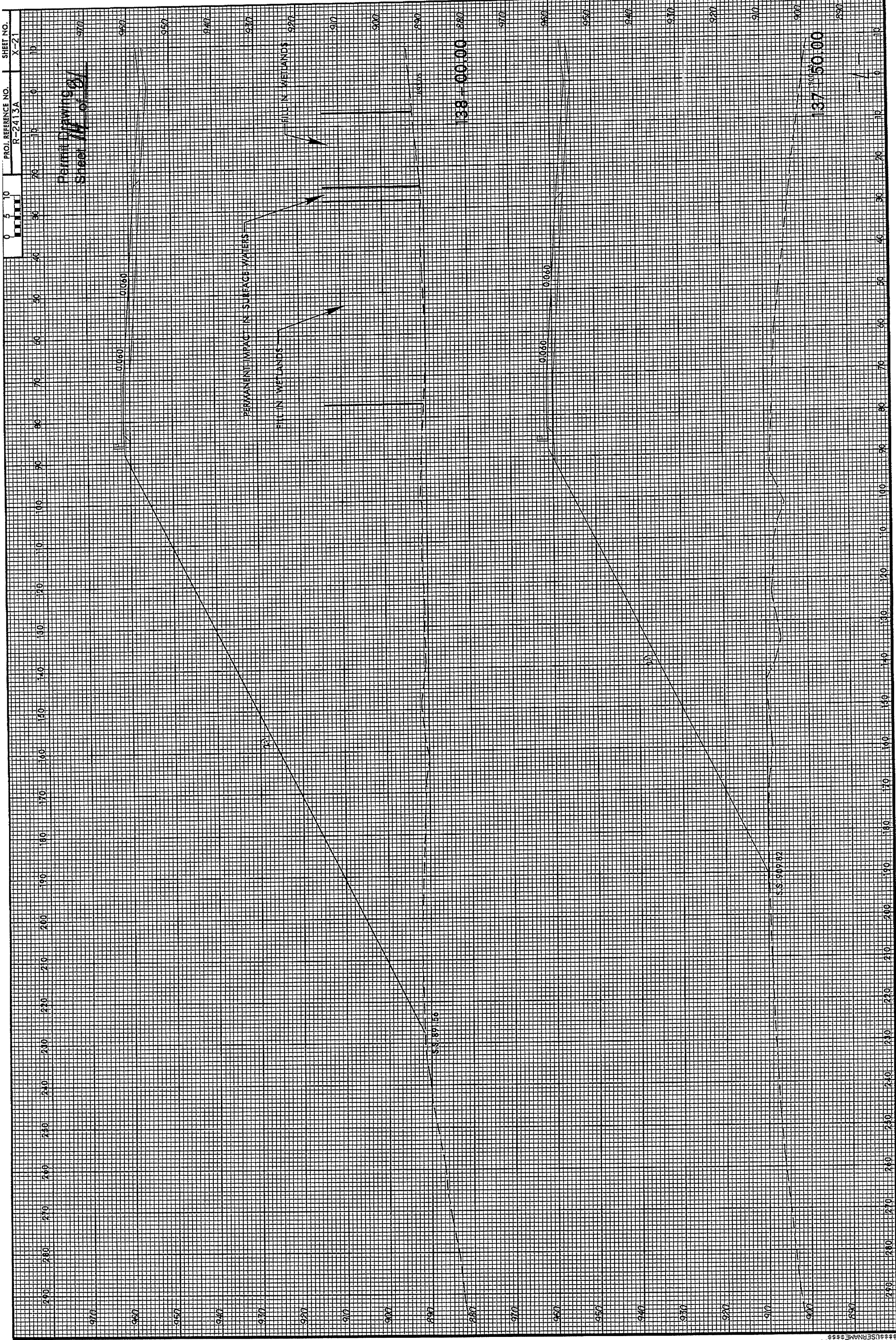

8/23/98
 *****SYSTEMS*****
 *****USER NAME: 8338*****
 *****DATE: 08/23/98*****

PROJECT REFERENCE NO. R-2413A	SHEET NO. 9
RDW SHEET NO. ROADWAY DESIGN ENGINEER	HYDRAULICS ENGINEER
PRELIMINARY PLANS DO NOT USE FOR CONSTRUCTION	

Permit Drawing
Sheet 15 of 81



SITE 5

- DENOTES IMPACTS IN SURFACE WATER
- DENOTES TEMPORARY IMPACTS IN SURFACE WATER
- DENOTES FILL IN WETLAND

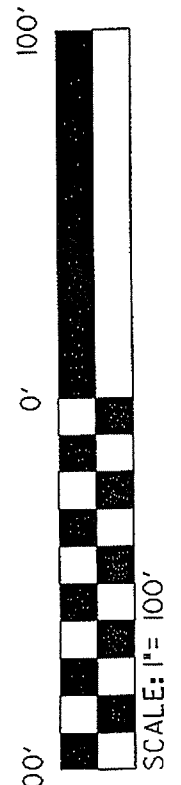
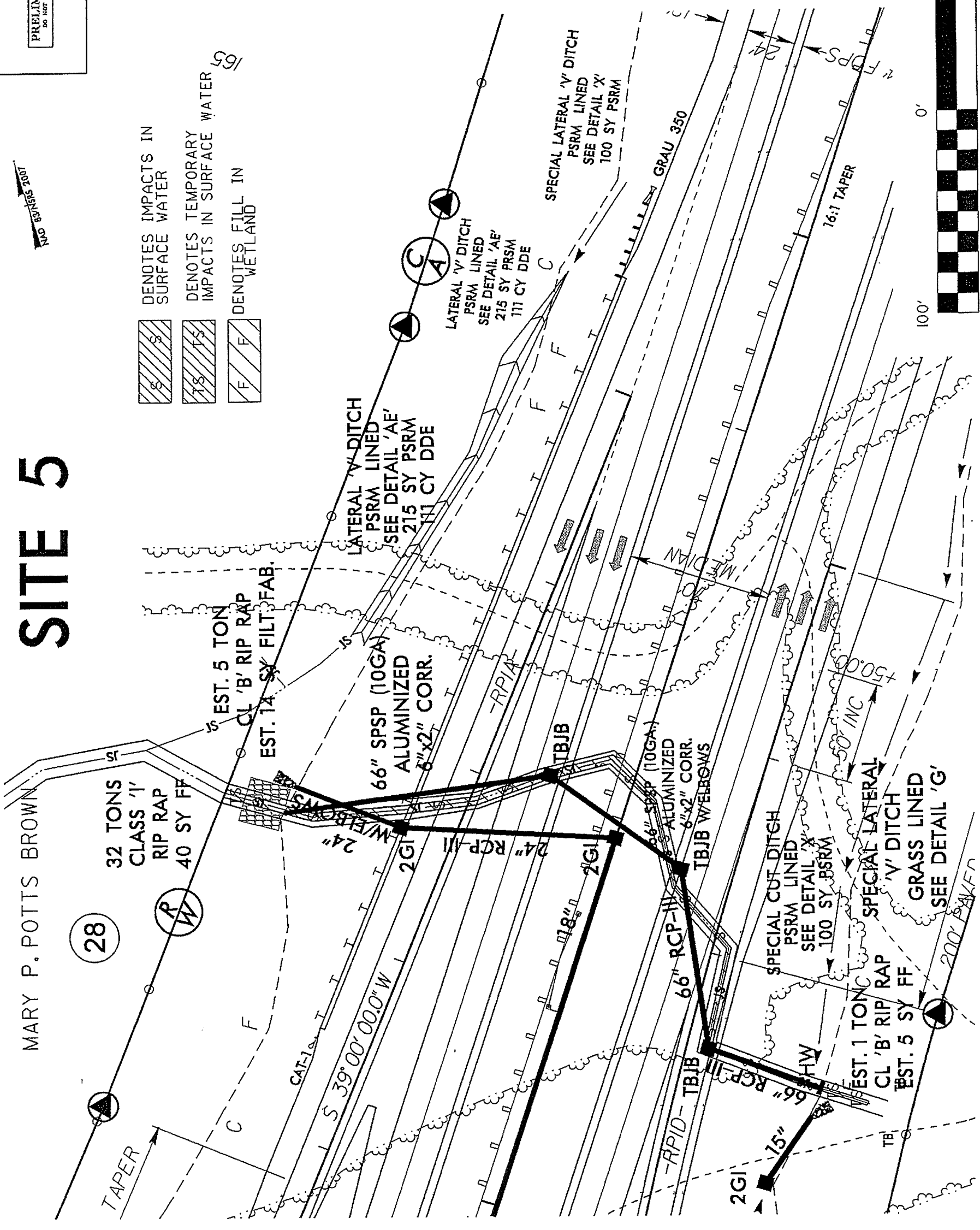

8/17/99

REVISIONS

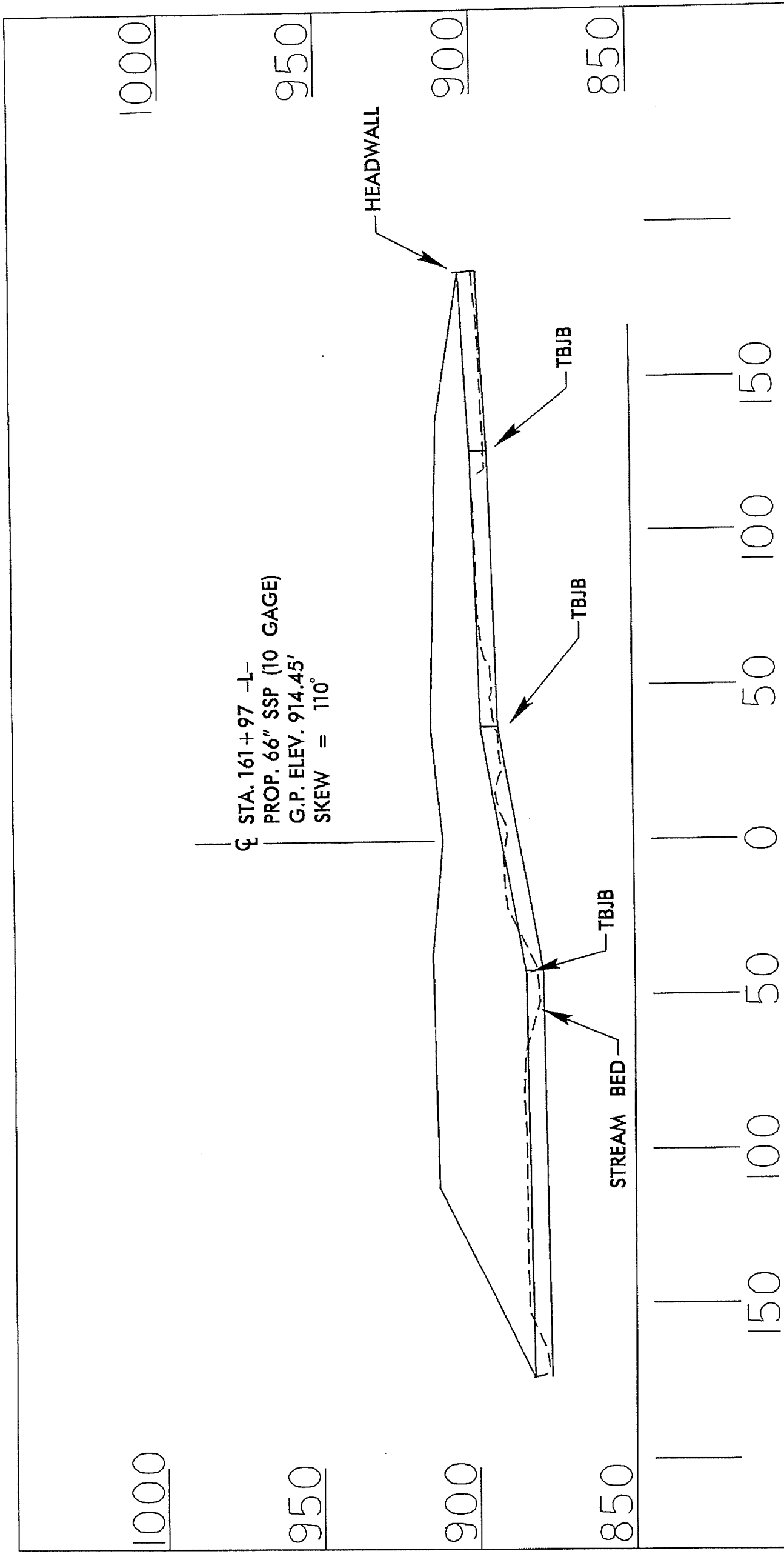



PROFILE

NCDOT
 DIVISION OF HIGHWAYS
 GUILFORD COUNTY
 PROJECT: 34429.1.1 (R-2413A)
 NC 68 CONNECTOR
 FROM FOUR LANES AT
 SR 2011 TO SR 2127
 SHEET 16 OF 81
 2/13/13

PROJECT REFERENCE NO. R-2413A	SHEET NO. 12
RAW SHEET NO. ROADWAY DESIGN ENGINEER	HYDRAULICS ENGINEER
PRELIMINARY PLANS DO NOT USE FOR CONSTRUCTION	

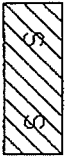
Permit Drawing 81
Sheet 19 of 81
NAD 83/NRS 2007

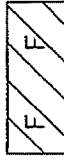
-  DENOTES IMPACTS IN SURFACE WATER
-  DENOTES TEMPORARY IMPACTS IN SURFACE WATER
-  DENOTES FILL IN WETLAND

SITE 6

4' LATERAL BASE DITCH
SEE DETAIL 'A'
460 TONS CLASS '1' RIP RAP
744 SY FF
4021 CY DDE

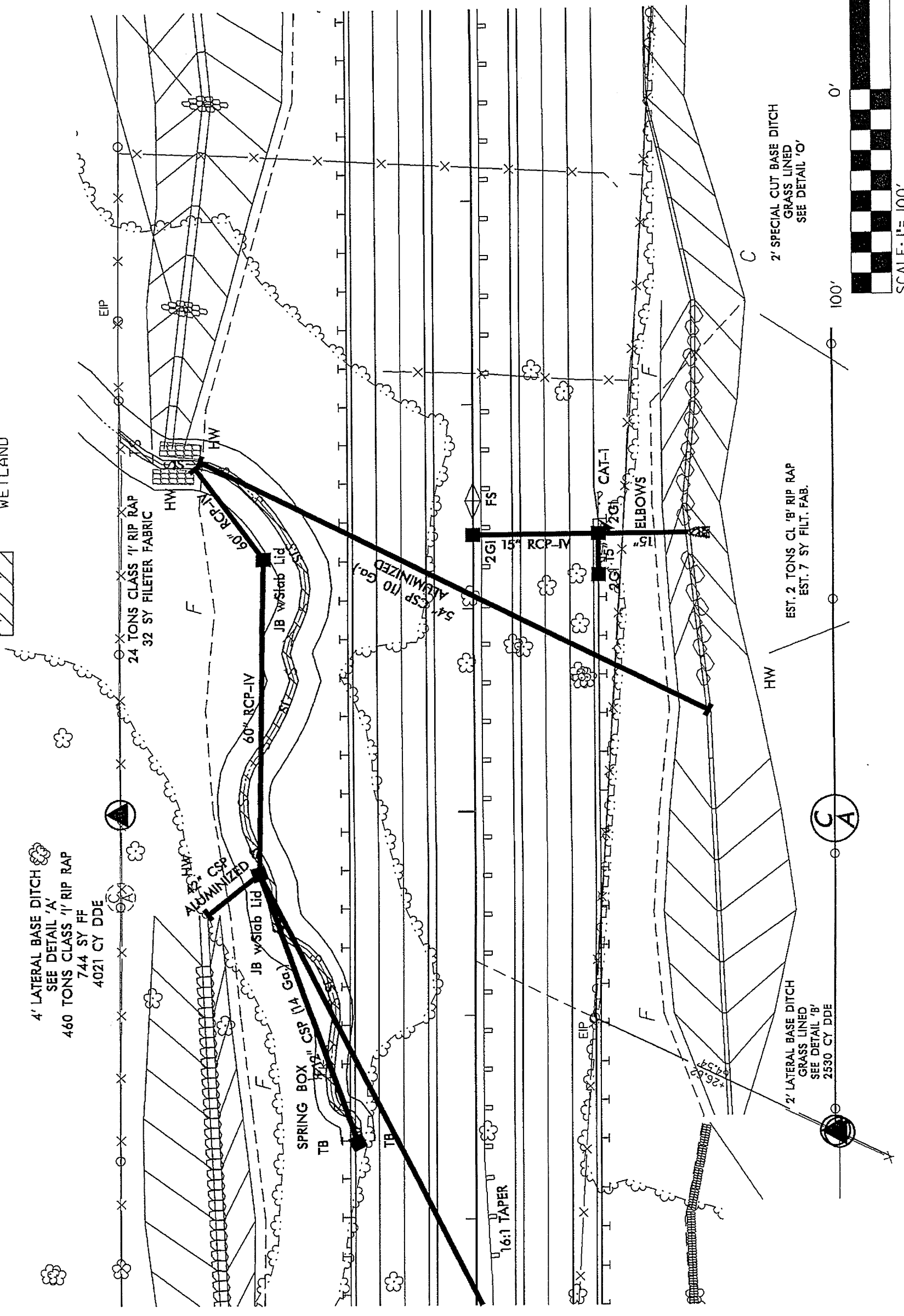

2' SPECIAL CUT BASE DITCH
GRASS LINED
SEE DETAIL 'O'

EST. 2 TONS CL 'B' RIP RAP
EST. 7 SY FILT. FAB.

2' LATERAL BASE DITCH
GRASS LINED
SEE DETAIL 'B'
2530 CY DDE

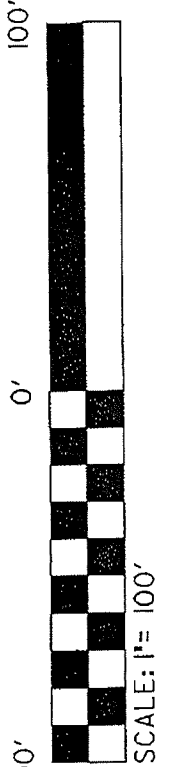

REVISIONS

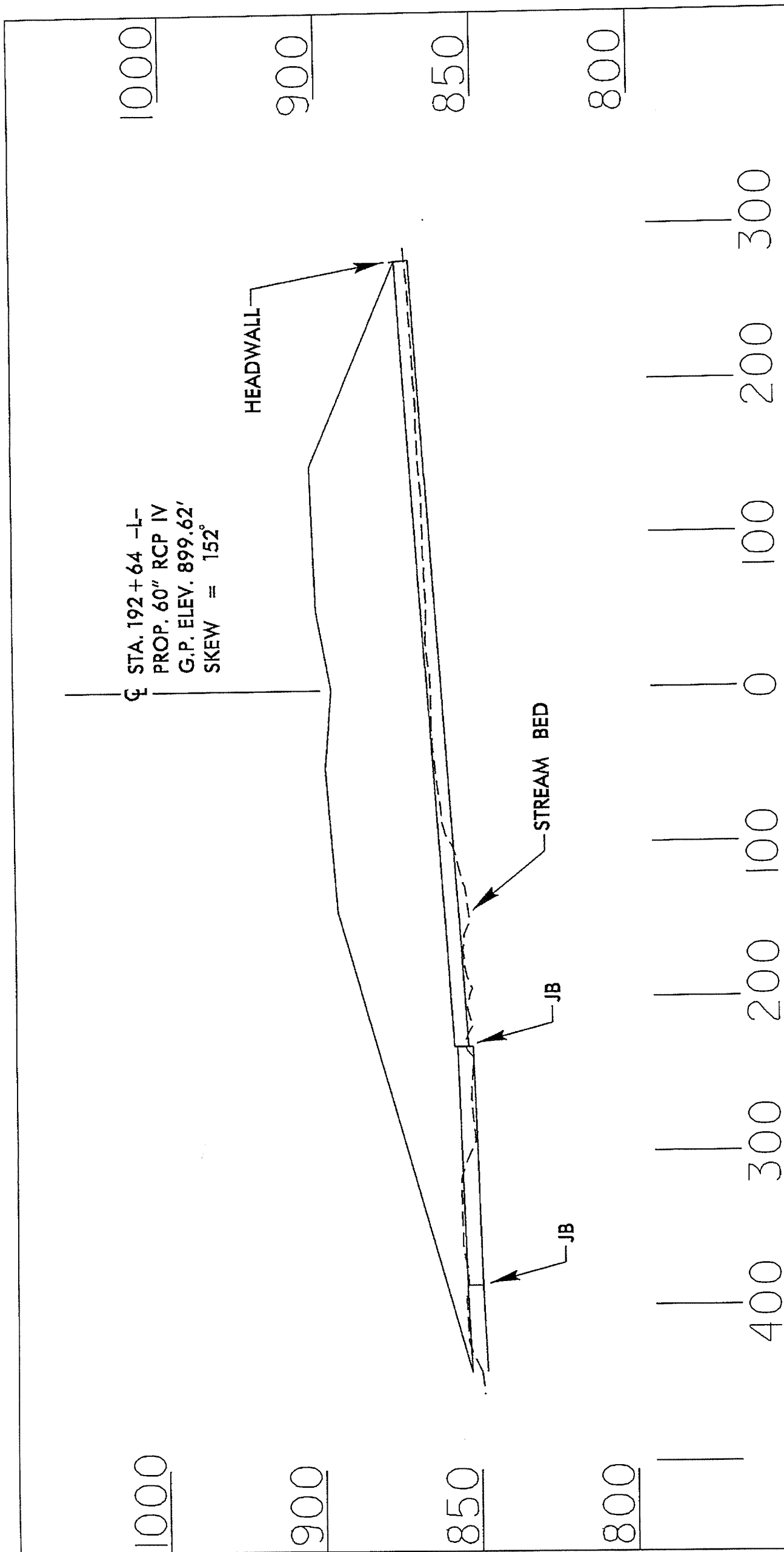

PROFILE

NCDOT
 DIVISION OF HIGHWAYS
 GUILFORD COUNTY
 PROJECT: 34429.1.1 (R-2413A)
 NC 68 CONNECTOR
 FROM FOUR LANES AT
 SR 2011 TO SR 2127

PROJECT REFERENCE NO. R-2413A
 SHEET NO. 73
 HYDRAULICS ENGINEER
 ROADWAY DESIGN ENGINEER
 PRELIMINARY PLANS
 DO NOT USE FOR CONSTRUCTION

Permit Drawn
 Sheet 21 of 81
 NAD 83/NSRS 2007

DETAIL
 1:1
 10' DIA. CHANNEL
 (Not to Scale)
 24 Tons of Crush '1' Rip-Rap
 32 Square Yards Filter Fabric

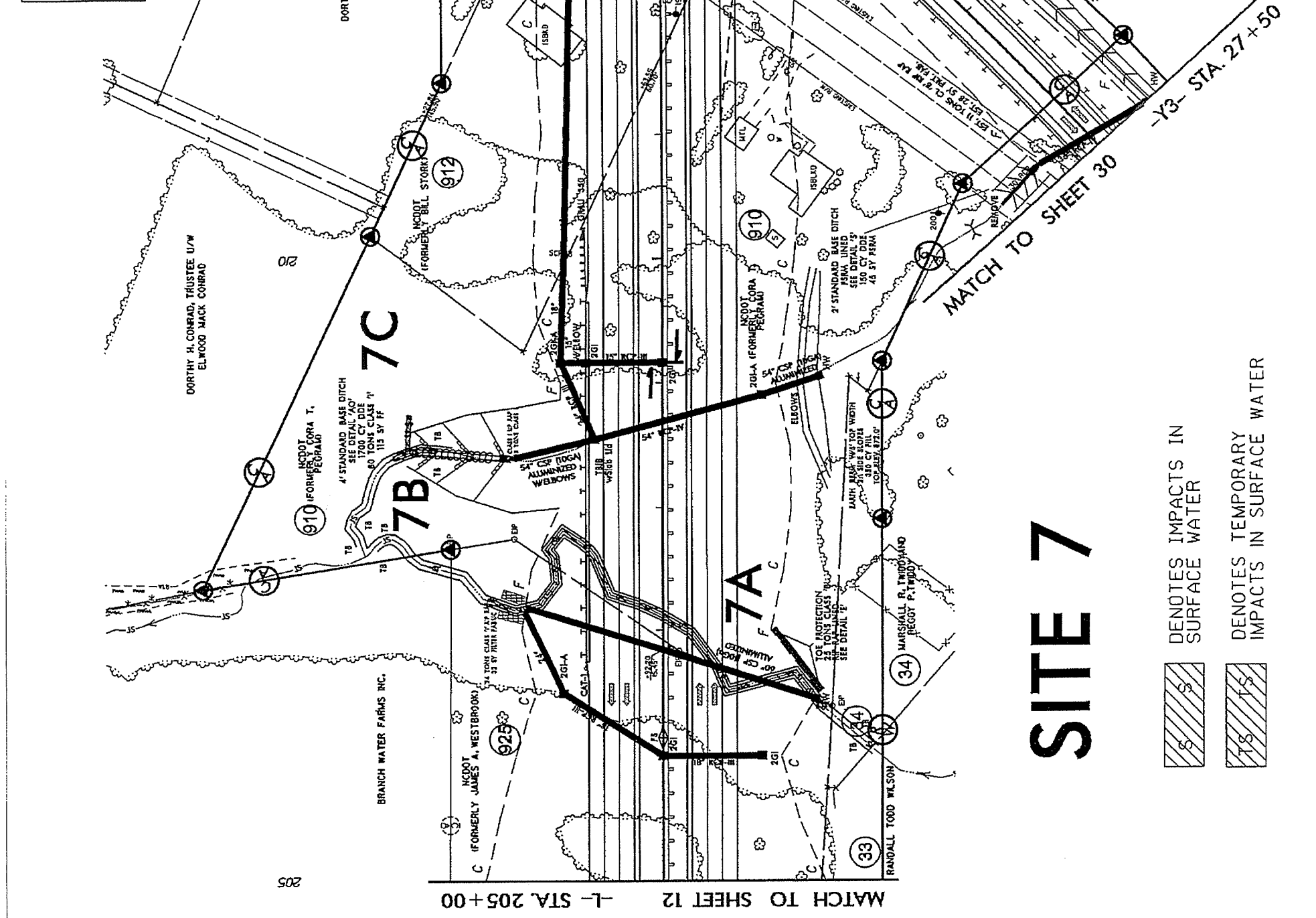

REVISIONS
 R/W REVISION: A PROPERTY LINE HAS BEEN ADDED TO PARCEL 36 WHICH RESULTED IN A NEW PARCEL DESIGNATED AS PARCEL 36A. PARCEL 36A IS OWNED BY THOMAS AND CATHY MORRISON. CEH 1/23/2013
 R/W REVISION: PARCEL NUMBER 80 HAS BEEN DELETED. NO CLAIM ON BRANCH WATER FARMS, INC. CEH 2/27/13
 B/17/99

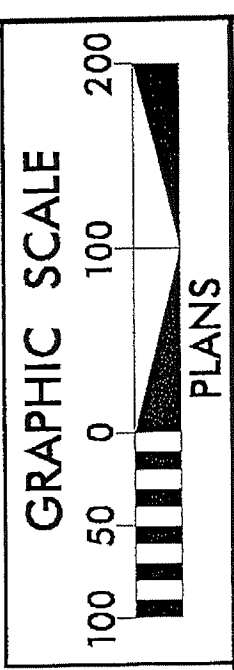

SITE 7

- DENOTES IMPACTS IN SURFACE WATER
- DENOTES TEMPORARY IMPACTS IN SURFACE WATER

R/W REVISION: A PROPERTY LINE HAS BEEN ADDED TO PARCEL 36 WHICH RESULTED IN A NEW PARCEL DESIGNATED AS PARCEL 36A. PARCEL 36A IS OWNED BY THOMAS AND CATY MORRISON. CEH 1/23/2013
 R/W REVISION: PARCEL NUMBER 80 HAS BEEN DELETED. NO CLAIM ON BRANCH WATER FARMS, INC. CEH 2/27/13
 8/17/99

PROJECT NUMBER: R-2433A	SHEET NO. 73
ROADWAY DESIGN ENGINEER	HYDRAULICS ENGINEER
PRELIMINARY PLANS DO NOT USE FOR CONSTRUCTION	

Permit Drawing
 Sheet 22 of 81
 NAD 83/NRS 2007

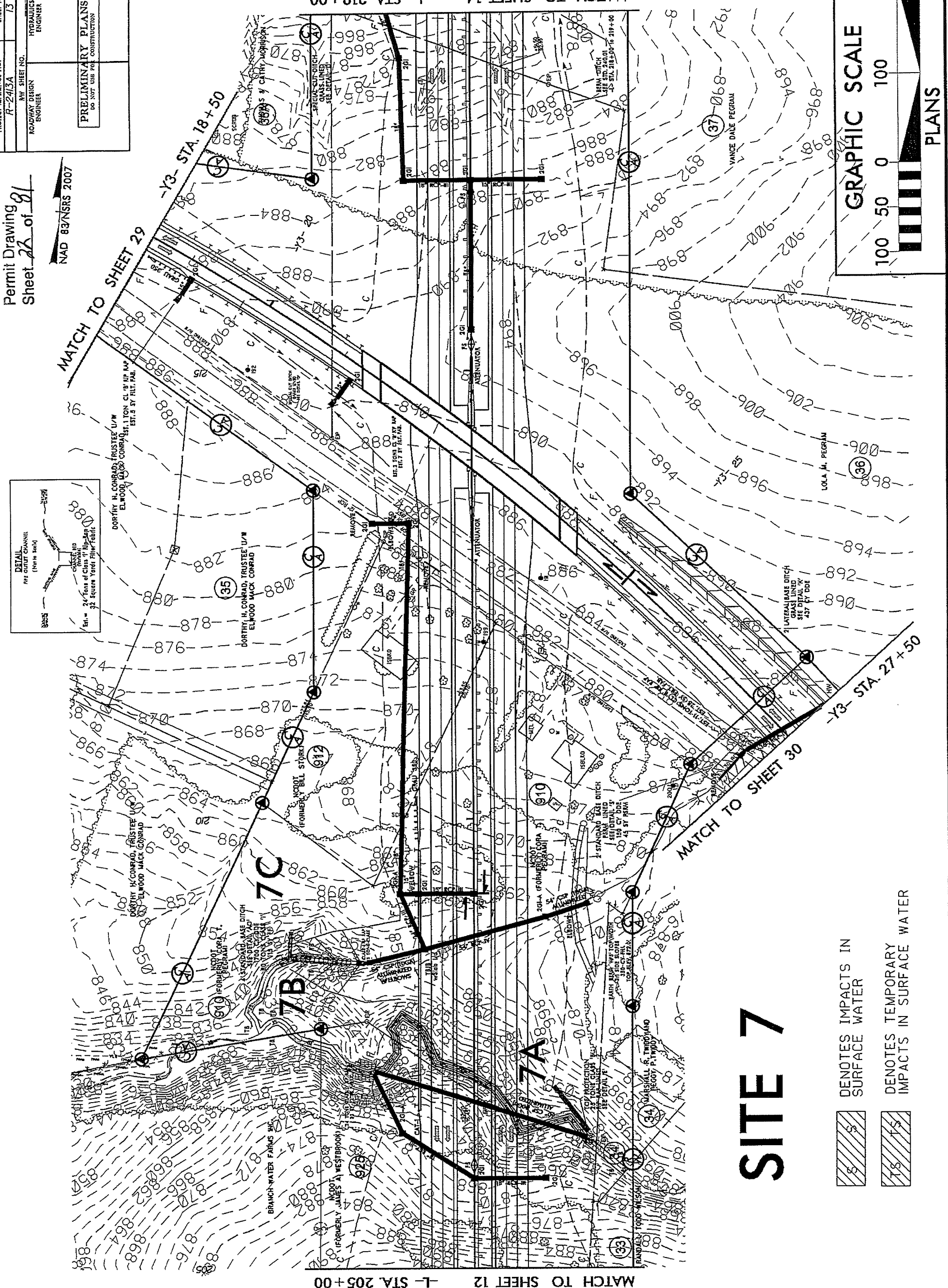
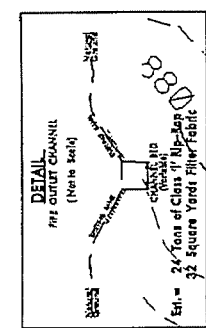

- DENOTES IMPACTS IN SURFACE WATER
- DENOTES TEMPORARY IMPACTS IN SURFACE WATER

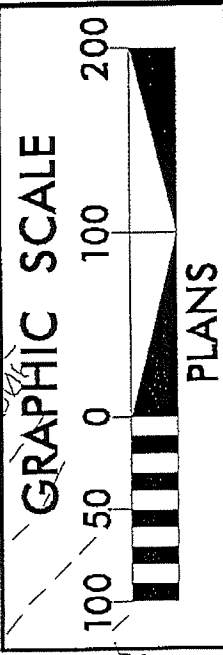

PROJECT REFERENCE NO. R-243A
 SHEET NO. 73
 ROADWAY DESIGN ENGINEER
 HYDRAULICS ENGINEER
PRELIMINARY PLANS
 DO NOT USE FOR CONSTRUCTION

Permit Drawing
 Sheet 23 of 81

NAD 83/NSRS 2007

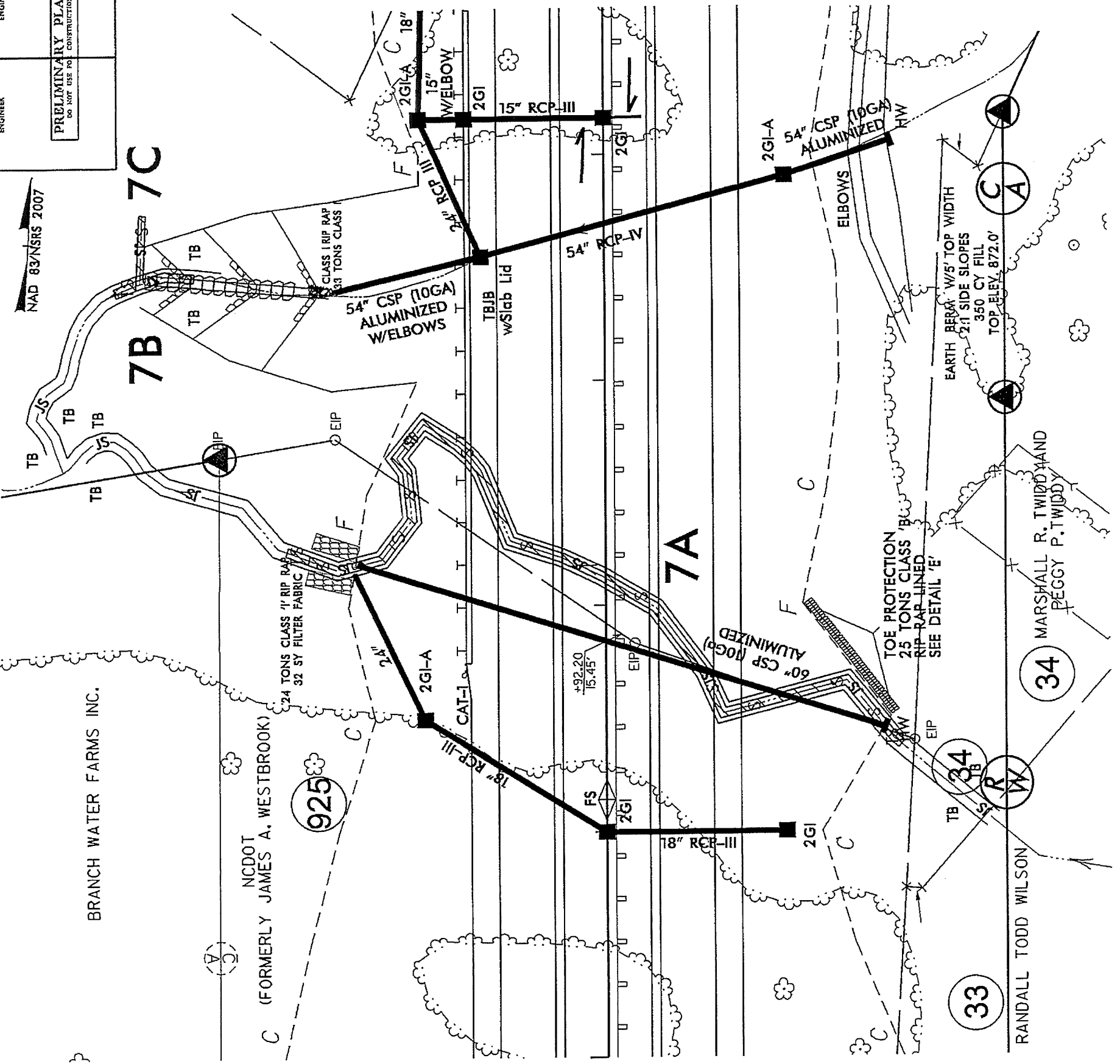

BRANCH WATER FARMS INC.

NCDOT (FORMERLY JAMES A. WESTBROOK)

925

7A

7B

7C

33



RANDALL TODD WILSON

34

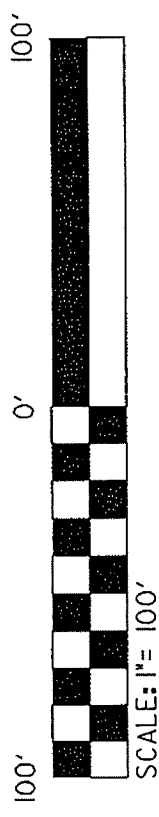
MARSHALL R. TWIDDY
 PEGGY P. TWIDDY

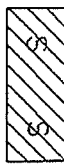

SITE 7

-  DENOTES IMPACTS IN SURFACE WATER
-  DENOTES TEMPORARY IMPACTS IN SURFACE WATER

REVISIONS

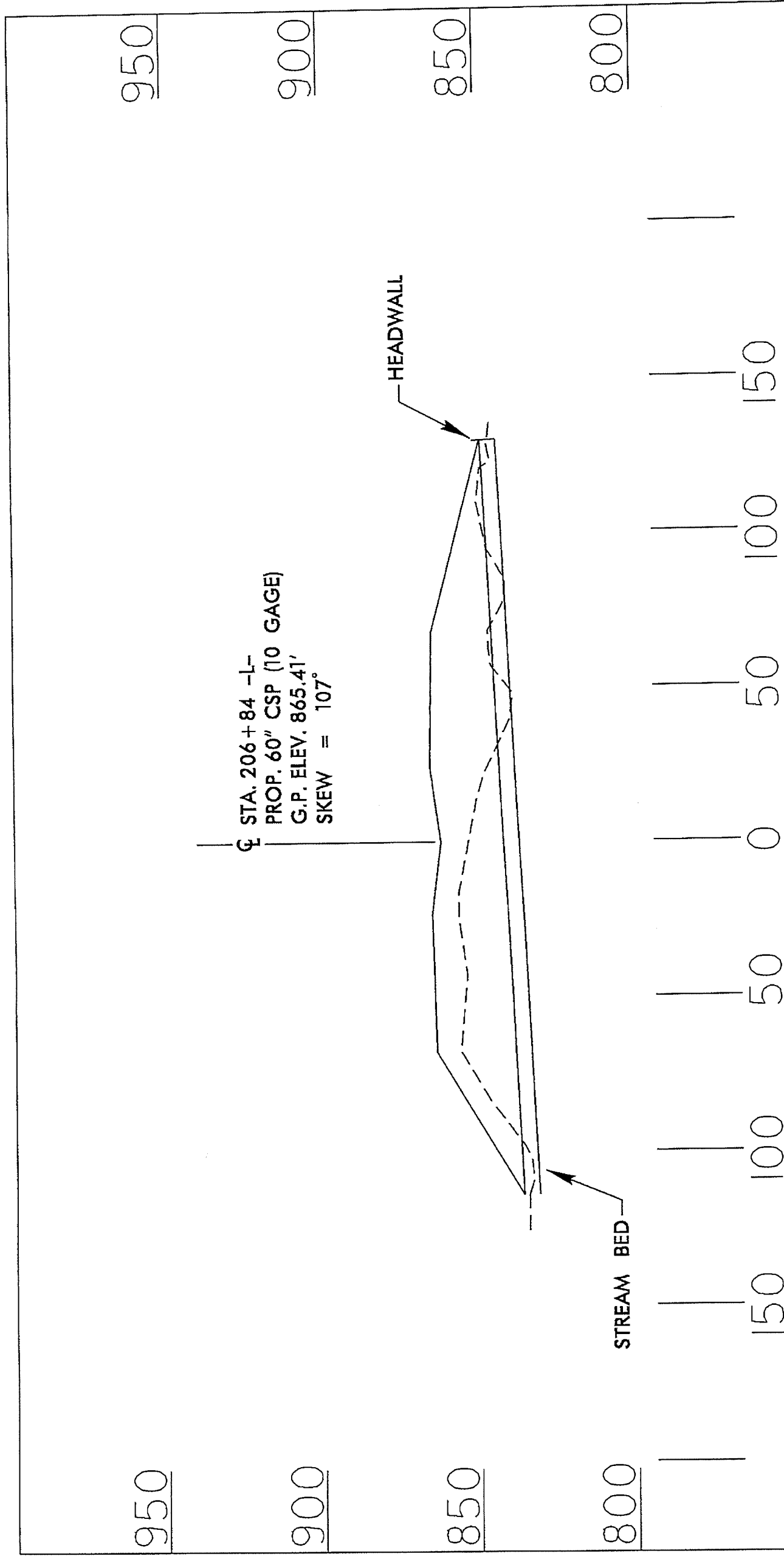

PROFILE

NCDOT
 DIVISION OF HIGHWAYS
 GUILFORD COUNTY
 PROJECT: 34429.1.1 (R-2413A)
 NC 68 CONNECTOR
 FROM FOUR LANES AT
 SR 2011 TO SR 2127

PROJECT REFERENCE NO. R-2413A
 SHEET NO. 14
 R/W SHEET NO. ROADWAY DESIGN ENGINEER
 HYDRAULICS ENGINEER
PRELIMINARY PLANS
 DO NOT USE FOR CONSTRUCTION

Permit Drawing 8/
 Sheet 16 of 8/
 NAD 83/NRS 2007

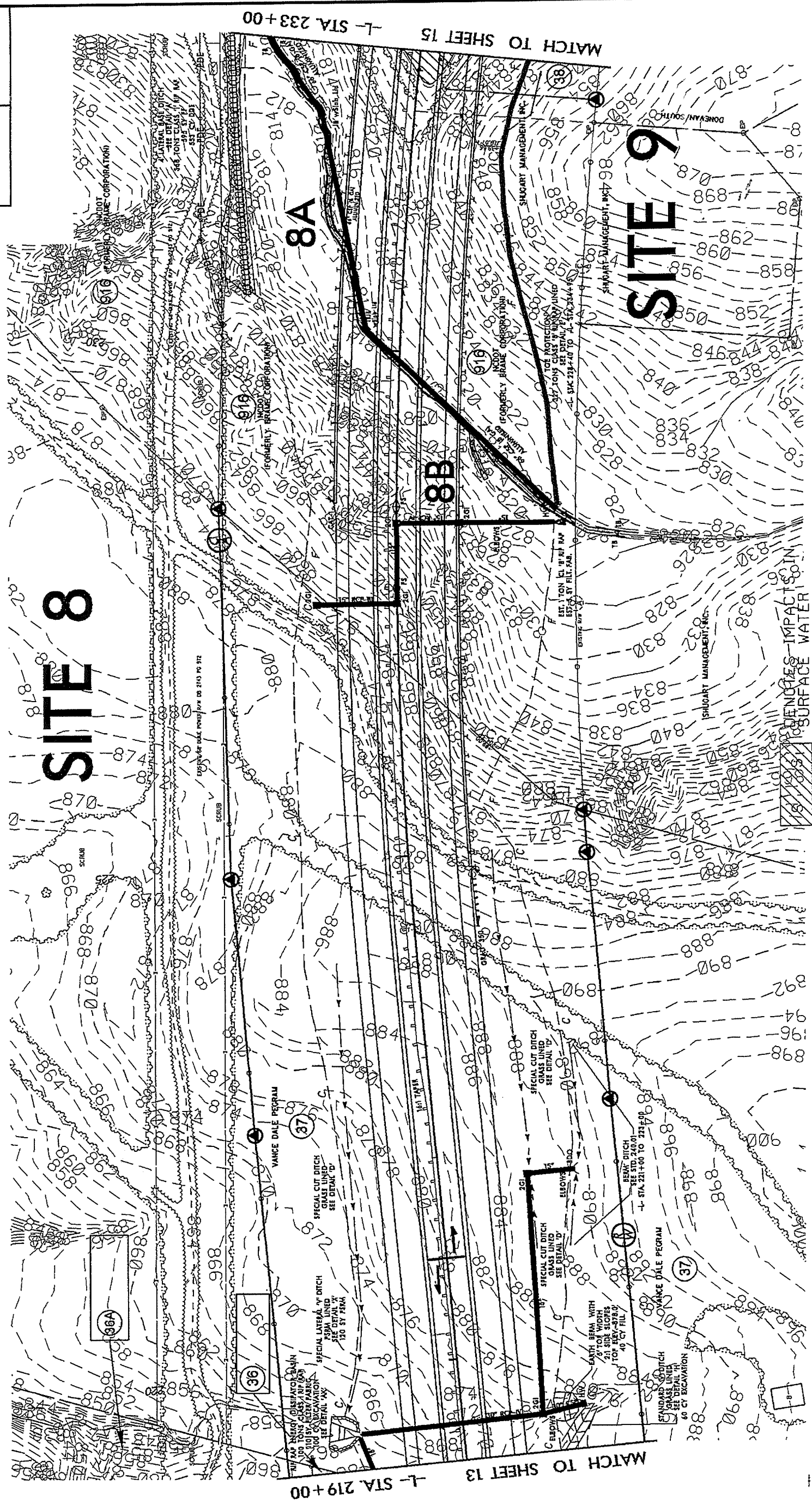
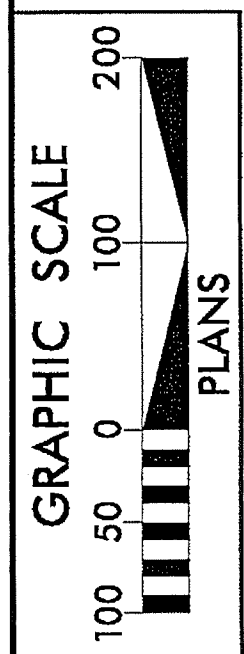

DENOTES TEMPORARY IMPACTS IN SURFACE WATER
 DENOTES IMPACTS IN SURFACE WATER (POND)

R/W REVISION: PARCEL 38 HAS BEEN SPLIT INTO THREE SEPARATE PARCELS, THE PROP. R/W LINE LOCATED RIGHT OF -L- BETWEEN STA. 232+65.68 AND STA. 235+30.83 HAS BEEN CHANGED TO AN EXIST. R/W LINE. CEH 11/21/2012
 R/W REVISION: A PROPERTY LINE HAS BEEN ADDED TO PARCEL 36 WHICH RESULTED IN NEW PARCEL DESIGNATED AS PARCEL 36A. PARCEL 36A IS OWNED BY THOMAS AND CATHY MORRISON. CEH 1/23/2013
 8/17/99

Permit Drawing
 Sheet 27 of 81

NAD 83/NRS 2007

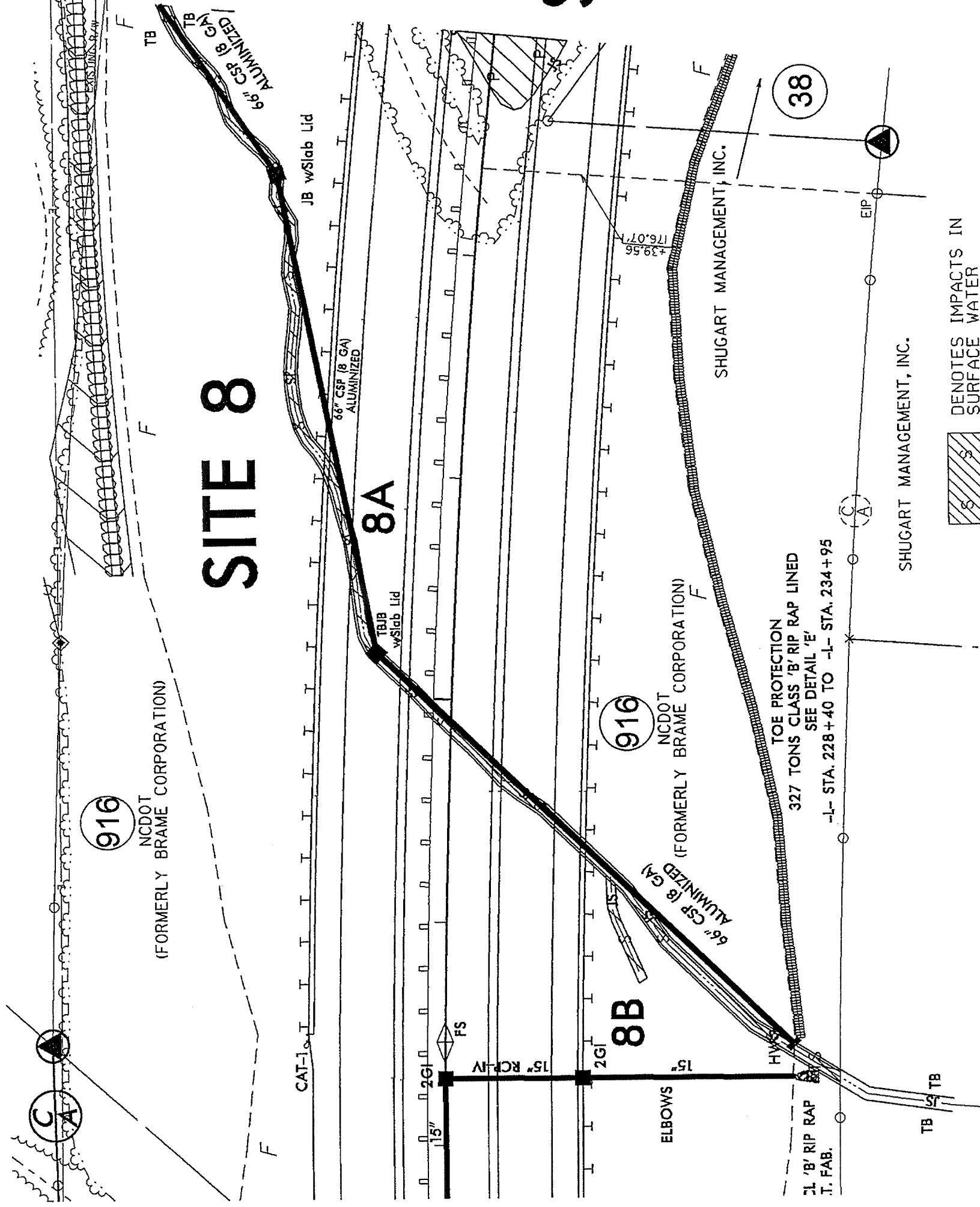

- DENOTES IMPACTS IN SURFACE WATER
- DENOTES TEMPORARY IMPACTS IN SURFACE WATER
- DENOTES IMPACTS IN SURFACE WATER (POND)

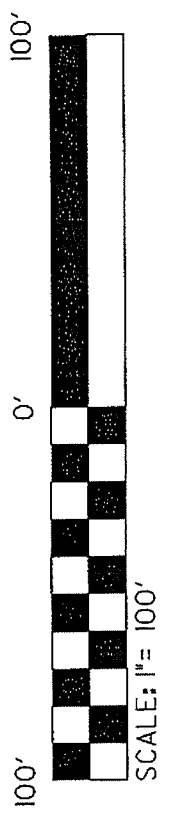

SITE 9

SITE 8

REVISIONS

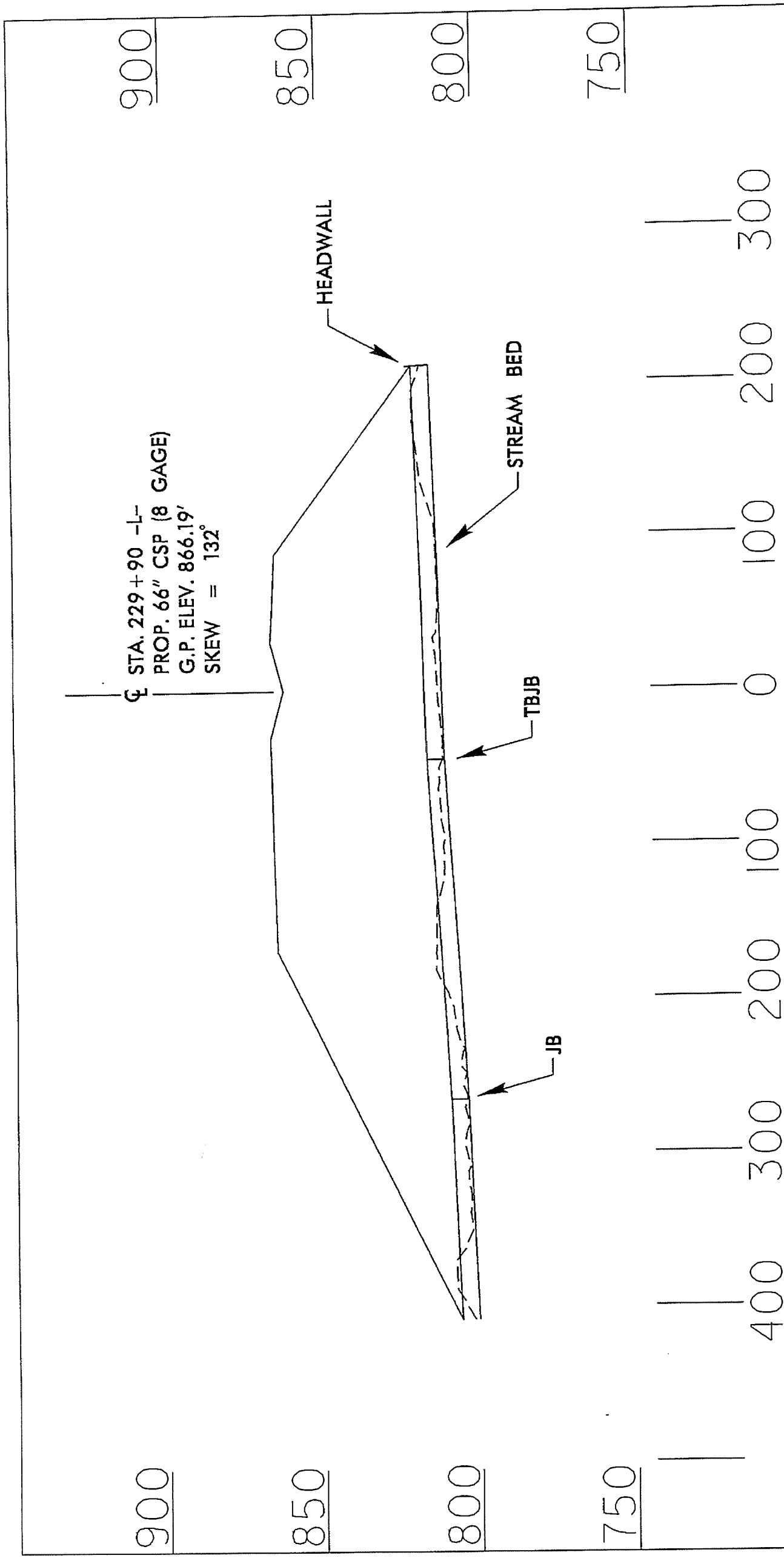

PROFILE

NCDOT
 DIVISION OF HIGHWAYS
 GUILFORD COUNTY
 PROJECT: 34429.1.1 (R-2413A)
 NC 68 CONNECTOR
 FROM FOUR LANES AT
 SR 2011 TO SR 2127

PROJECT REFERENCE NO. R-243A	SHEET NO. 75
ROADWAY DESIGN ENGINEER	HYDRAULICS ENGINEER
PRELIMINARY PLANS DO NOT USE FOR CONSTRUCTION	

Permit Drawing
Sheet 8 of 8

NAD 83/NSRS 2007

SITE 8

SITE 9

SITE 10

10A 10B

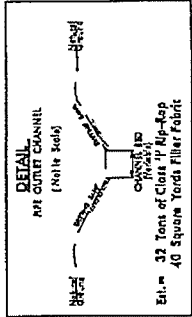
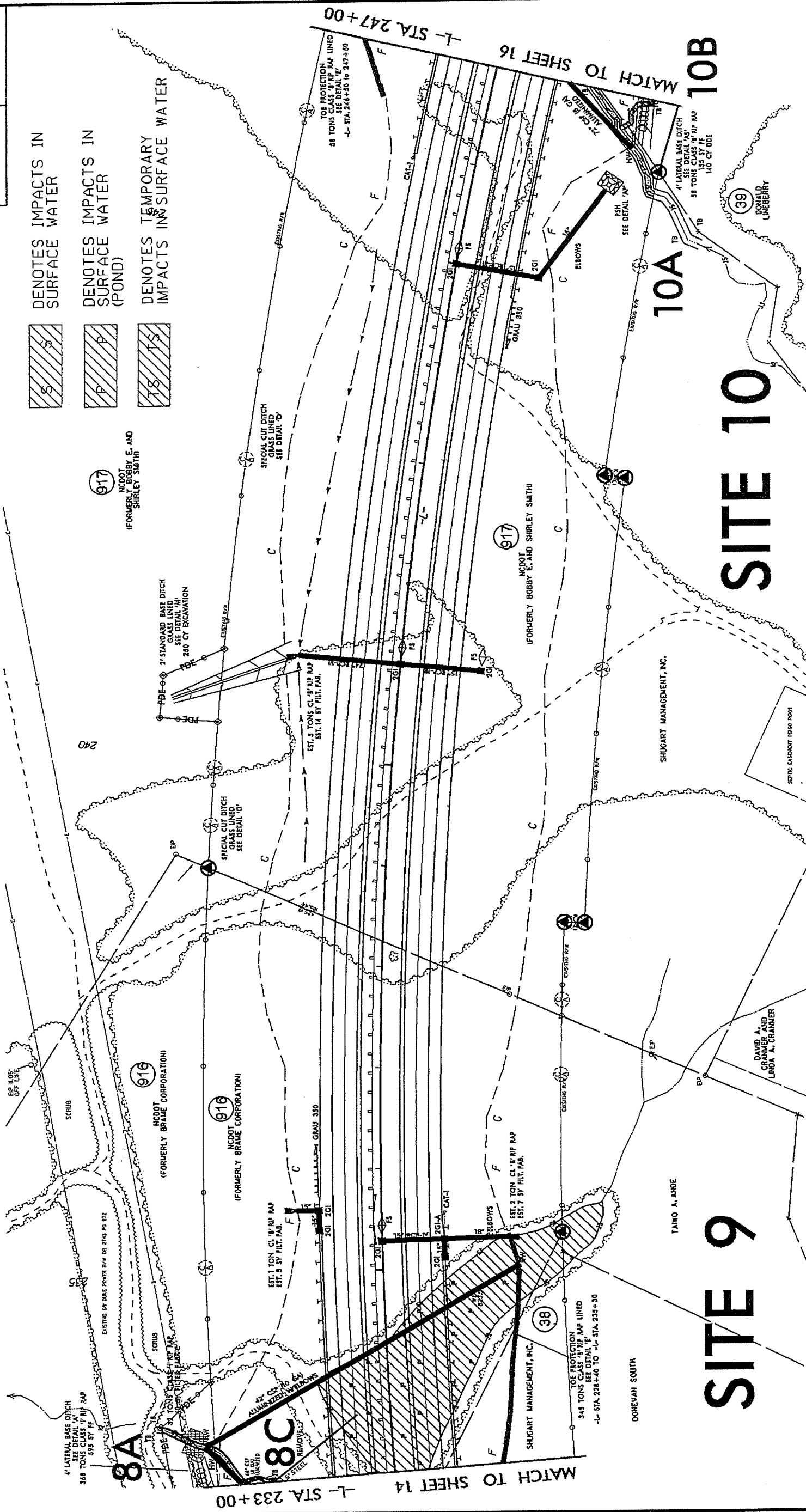

REVISIONS
 R/W REVISION: PARCEL 39 HAS BEEN SPLIT INTO THREE SEPARATE PARCELS. THE PROP. R/W LINE LOCATED RIGHT OF -L- BETWEEN STA. 232+65.88 AND STA. 235+30.83 HAS BEEN CHANGED TO AN EXIST. R/W LINE. CEH 11/21/2012
 8/17/99

FOR -L- PROFILE, SEE SHEET NO. 41
 FOR DITCH DETAILS, SEE SHEET NOS. 2-W & 2-X

PROJECT REFERENCE NO.	R-2413A
BY SHEET NO.	75
ROADWAY DESIGN ENGINEER	PROJANALYSIS ENGINEER
PRELIMINARY PLANS DO NOT USE FOR CONSTRUCTION	

Permit Drawing
 Sheet 30 of 81
 NAD 83/NSRS 2007

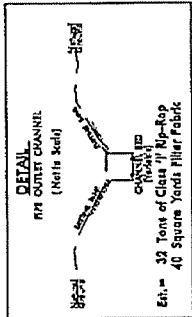

SITE 8

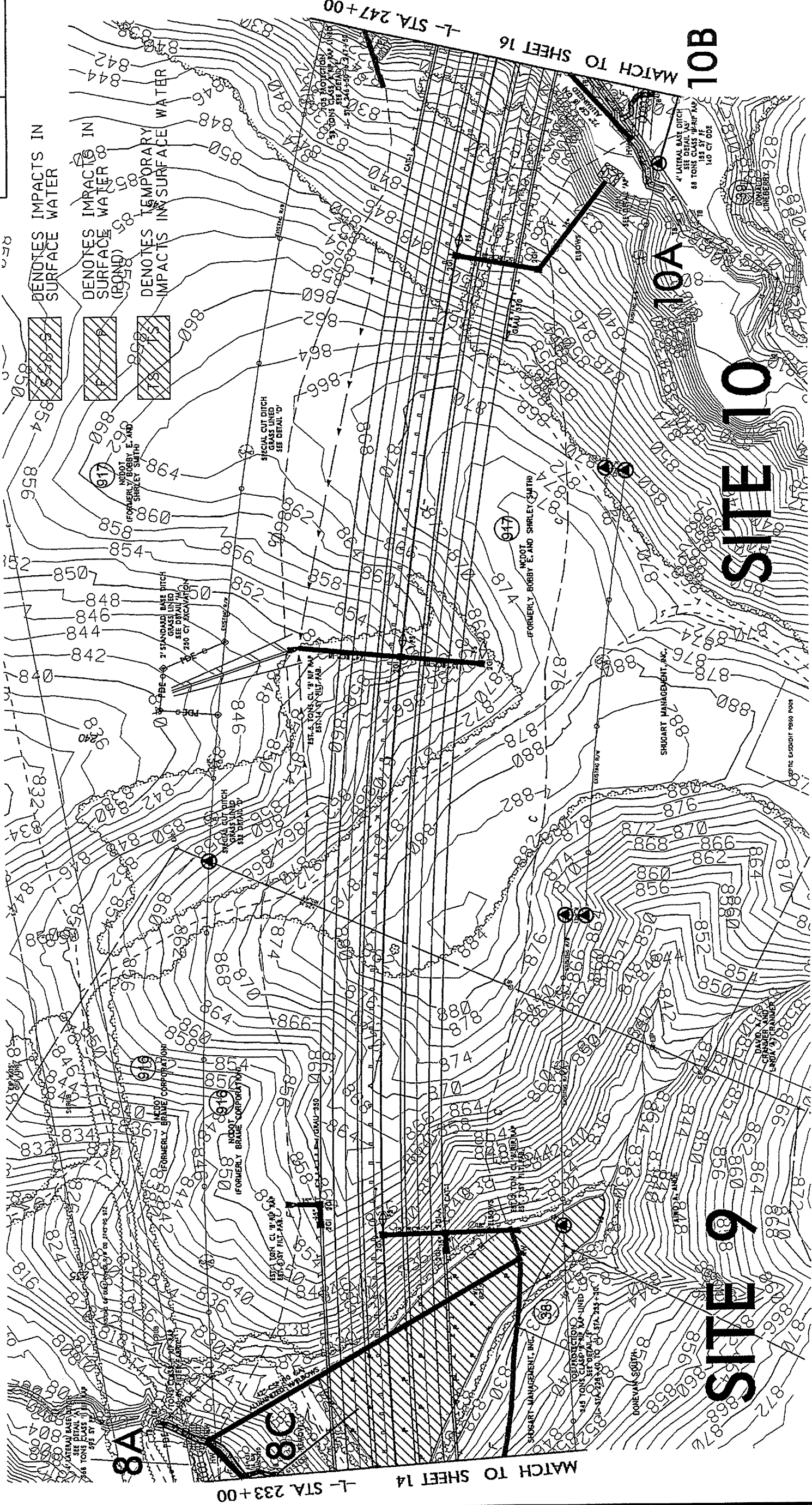

DENOTES IMPACTS IN SURFACE WATER
 DENOTES IMPACTS IN SURFACE WATER (ROUND)
 DENOTES TEMPORARY IMPACTS IN SURFACE WATER

MATCH TO SHEET 14
 -L- STA. 233+00

MATCH TO SHEET 16
 -L- STA. 247+00

SITE 9

SITE 10

10A

10B

FOR -L- PROFILE, SEE SHEET NO. 41
 FOR DITCH DETAILS, SEE SHEET NOS. 2-W & 2-X

REVISIONS
 R/W REVISION, PARCEL 38 HAS BEEN SPLIT INTO THREE SEPARATE PARCELS, THE PROP. R/W LINE LOCATED RIGHT OF -L- BETWEEN STA. 232+55.88 AND STA. 235+30.83 HAS BEEN CHANGED TO AN EXIST. R/W LINE. CEH 11/21/2012

PERMIT DRAWING NO. R-24/3A
 ROADWAY DESIGN ENGINEER
 HYDRAULICS ENGINEER
 PRELIMINARY PLANS
 DO NOT USE FOR CONSTRUCTION

Permit Drawing 8/ of 8/
 NAD 83/NSRS 2007

SITE 8

8A

8C

-  DENOTES IMPACTS IN SURFACE WATER
-  DENOTES IMPACTS IN SURFACE WATER (POND)
-  DENOTES TEMPORARY IMPACTS IN SURFACE WATER

SITE 9

SHUGART MANAGEMENT, INC.

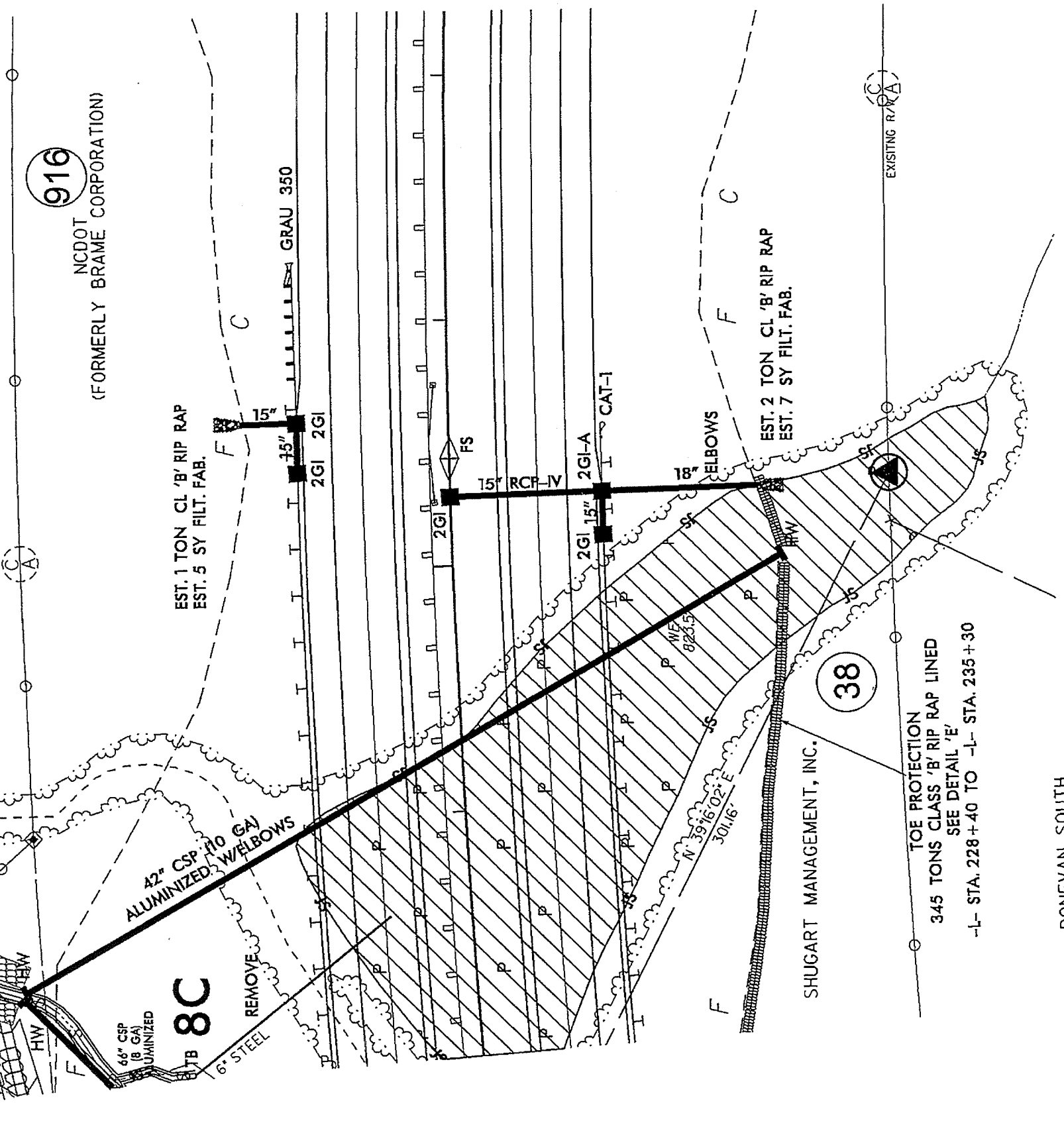
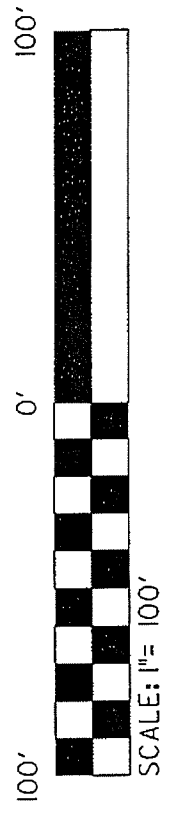

REVISIONS

NO.	DESCRIPTION

PROJECT REFERENCE NO. R-2413A
 SHEET NO. 16
 HYDRAULICS ENGINEER
 ROADWAY DESIGN ENGINEER
 PRELIMINARY PLANS
 DO NOT USE FOR CONSTRUCTION

Permit Drawing 81
 Sheet 23 of 81
 NGS 5/28/07

SITE 10

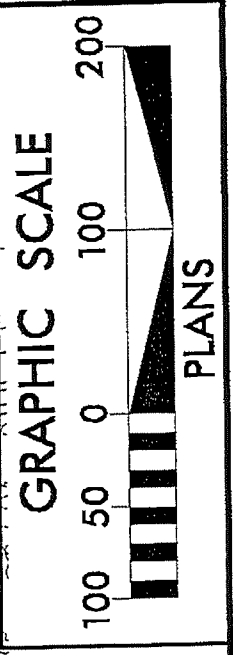
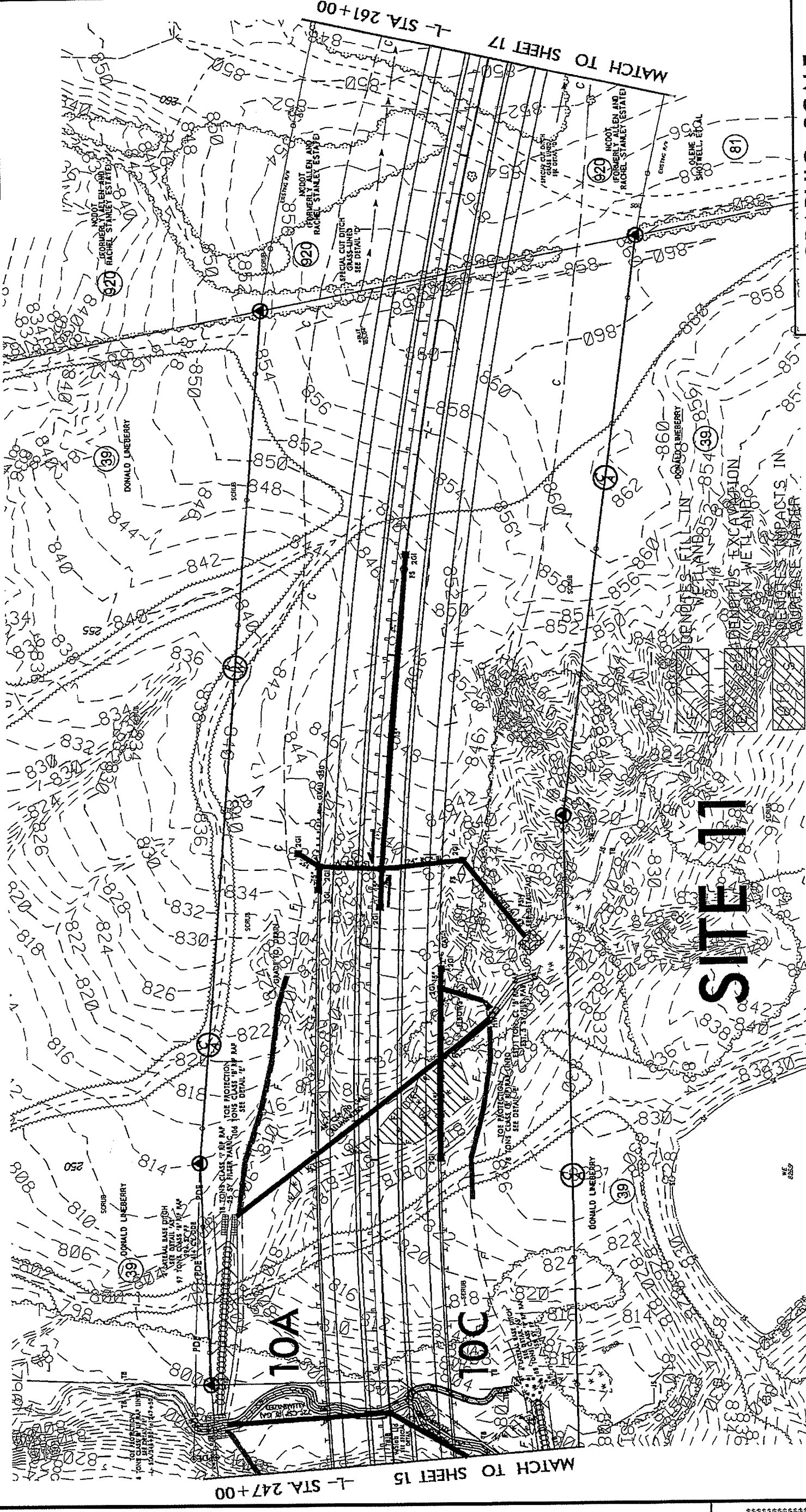

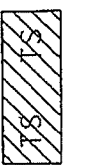
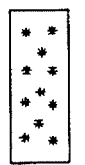
-  DENOTES TEMPORARY IMPACTS IN SURFACE WATER
-  DENOTES MECHANIZED CLEARING

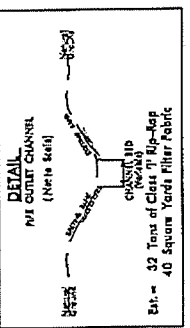

REVISIONS

PROJECT REFERENCE NO. R-2413A
 SHEET NO. 16
 HW SHEET NO. HYDRAULICS ENGINEER
 ROADWAY DESIGN ENGINEER
 PRELIMINARY PLANS
 DO NOT USE FOR CONSTRUCTION

Permit Drawing
 Sheet 24 of 21
 MVD 5/25/99, C.M.

39 DONALD LINEBERRY

4' LATERAL BASE DITCH
 SEE DETAIL 'AS'
 97 TONS CLASS 'B' RIP RAP
 294 SY FF
 PDE 414 CY DDE

TOE PROTECTION
 18 TONS CLASS '1' RIP RAP
 25 SY FILTER FABRIC
 106 TONS CLASS 'B' RIP RAP
 SEE DETAIL 'E'

SITE 11

48" CSP (10 GA)
 ALUMINIZED

- DENOTES FILL IN WETLAND
- DENOTES EXCAVATION IN WETLAND
- DENOTES IMPACTS IN SURFACE WATER
- DENOTES TEMPORARY IMPACTS IN SURFACE WATER
- DENOTES MECHANIZED CLEARING

10A

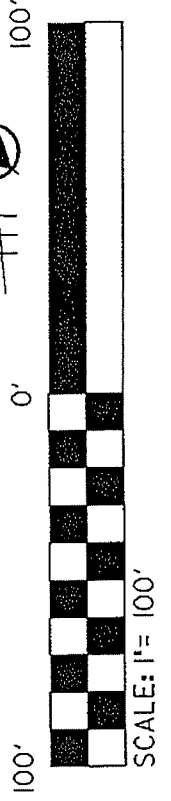

TOE PROTECTION
 58 TONS CLASS 'B' RIP RAP LINED
 SEE DETAIL 'E'
 -L- STA. 246+50 TO 247+50

EXISTING PAVEMENT

72" CSP (8 GA)
 ALUMINIZED

TBJB
 W/SIGID Lid
 SEE SPECIAL
 DETAIL

10C

4' LATERAL BASE DITCH
 SEE DETAIL 'AS'
 58 TONS CLASS 'B' RIP RAP
 155 SY FF

10B

DONALD LINEBERRY

39

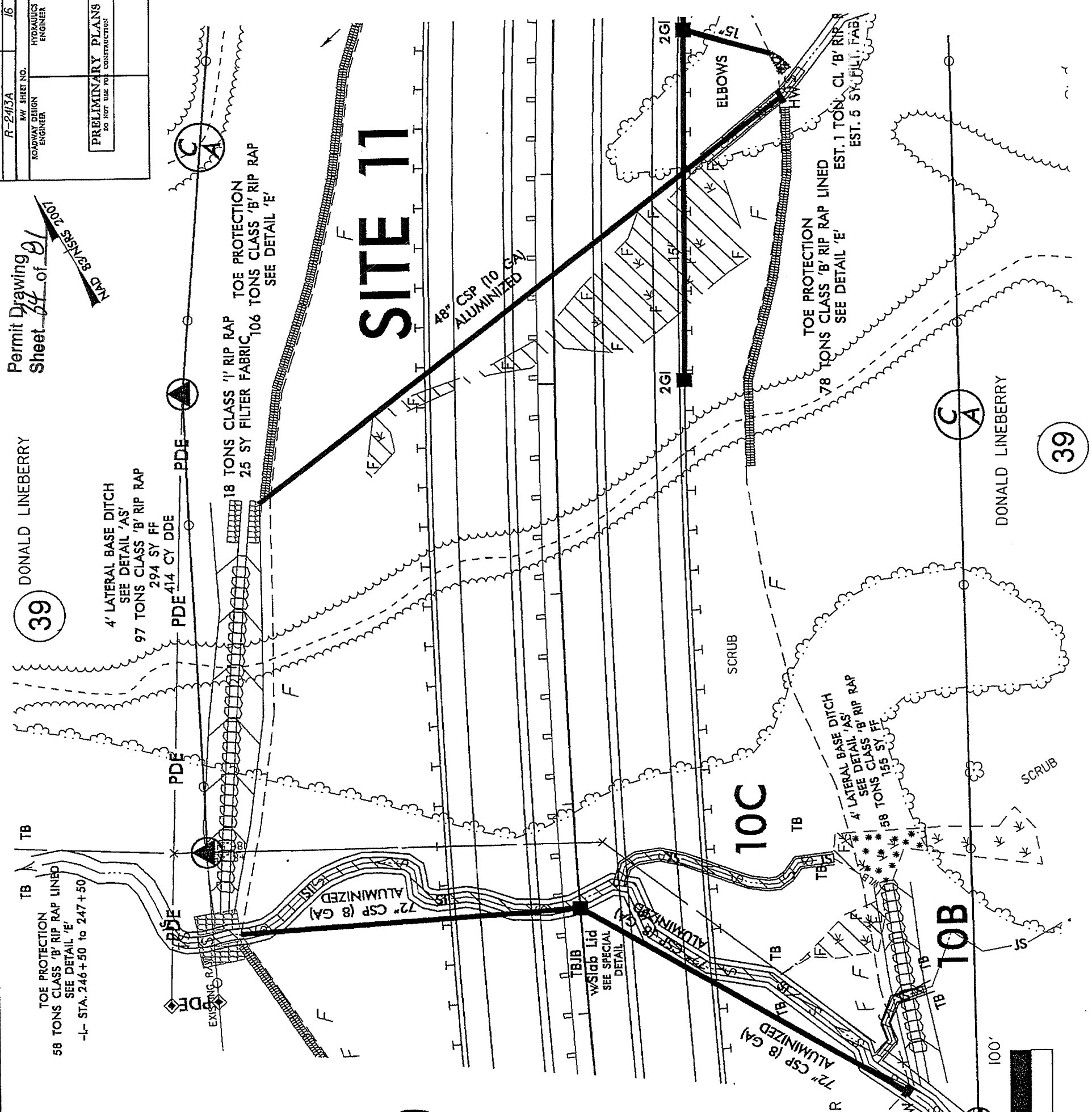

REVISIONS

NO.	DATE	DESCRIPTION

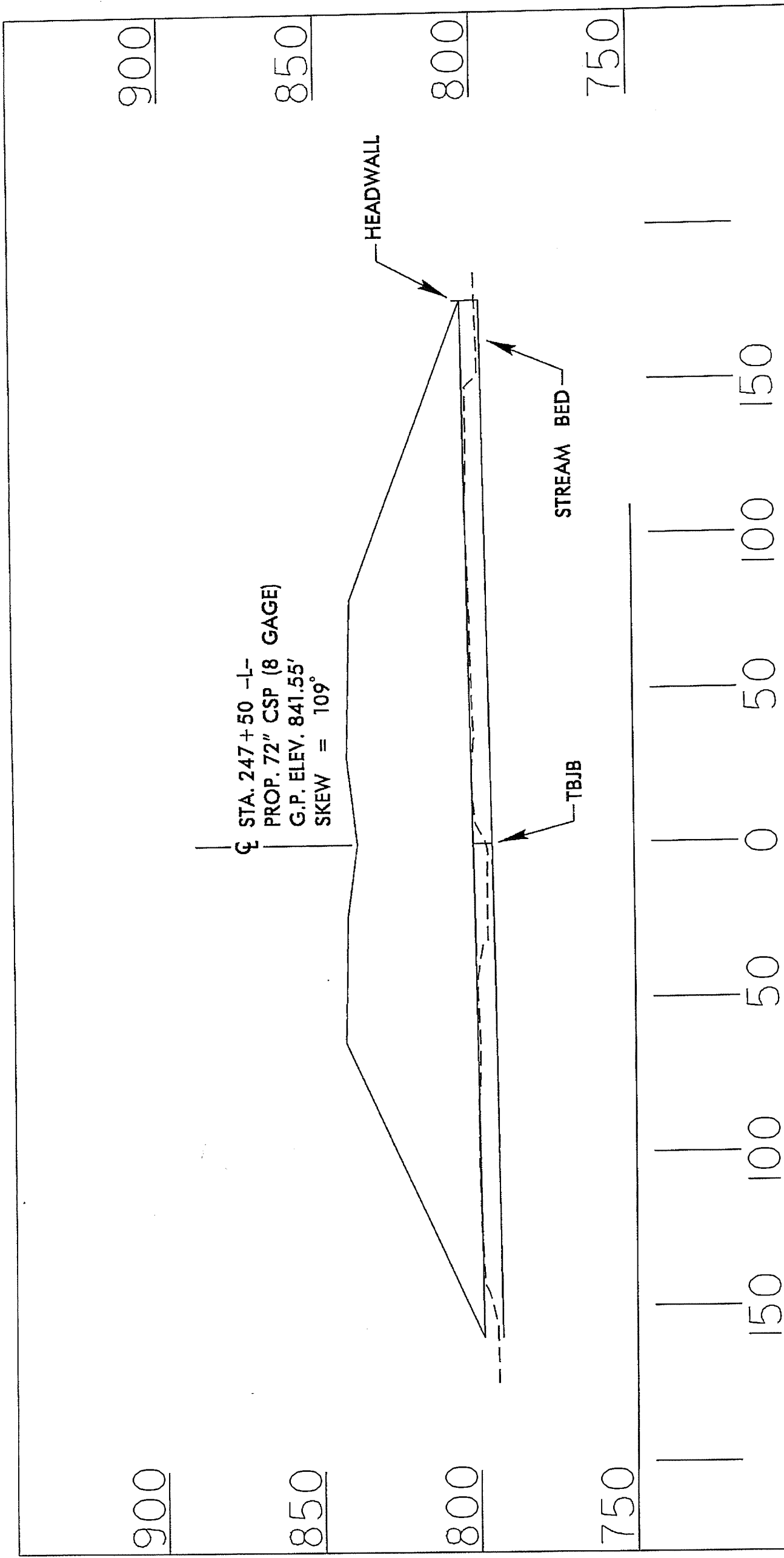

PROFILE

NCDOT
 DIVISION OF HIGHWAYS
 GUILFORD COUNTY
 PROJECT: 34429.1.1 (R-2413A)
 NC 68 CONNECTOR
 FROM FOUR LANES AT
 SR 2011 TO SR 2127

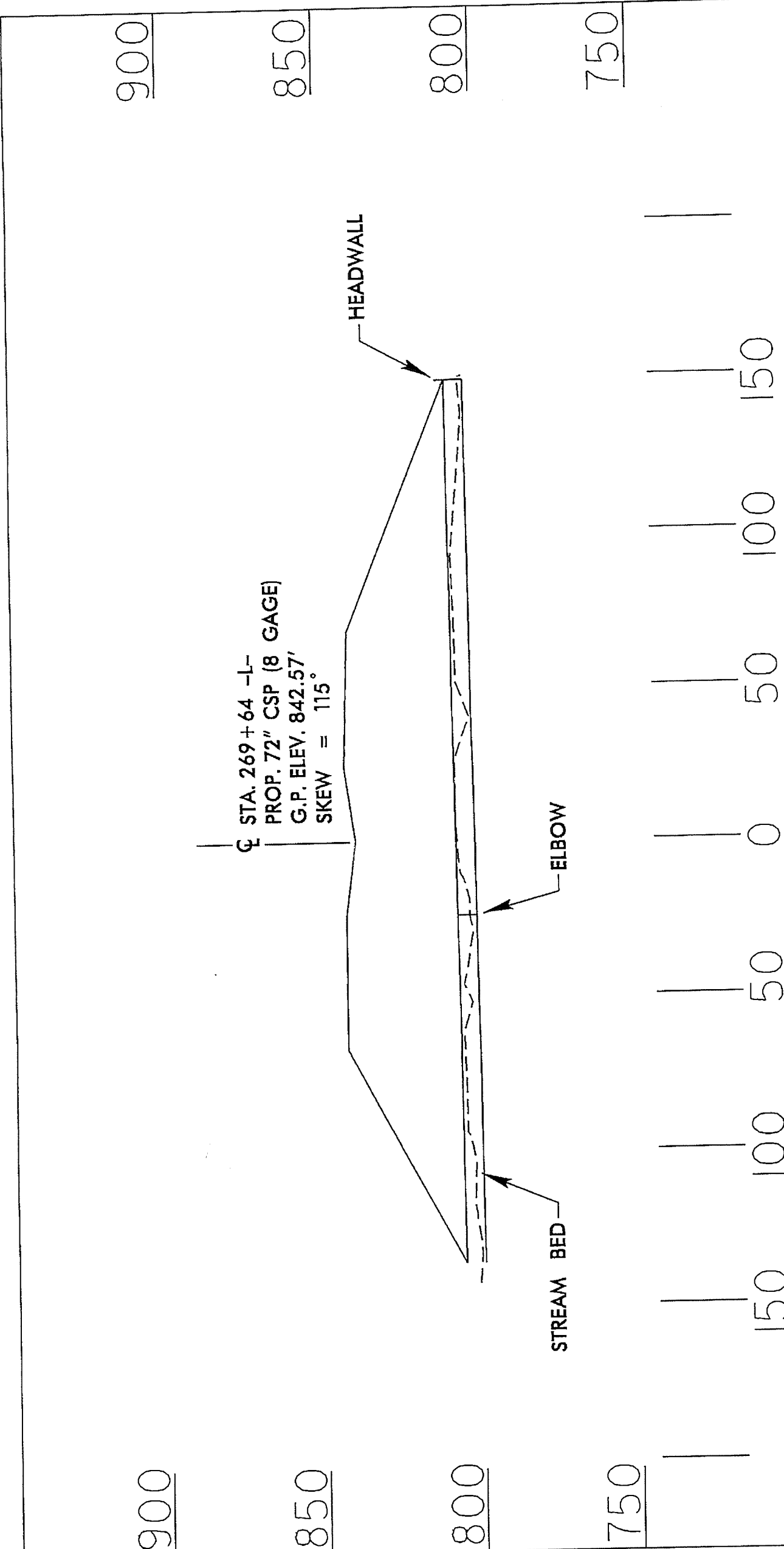

PROFILE



NCDOT
 DIVISION OF HIGHWAYS
 GUILFORD COUNTY
 PROJECT: 34429.1.1 (R-2413A)
 NC 68 CONNECTOR
 FROM FOUR LANES AT
 SR 2011 TO SR 2127

PROJECT REFERENCE NO. R-2413A	SHEET NO. 18
R/W SHEET NO. ROADWAY DESIGN ENGINEER	HYDRAULICS ENGINEER
PRELIMINARY PLANS DO NOT USE FOR CONSTRUCTION	

Permit Drawing
Sheet 42 of 81

MAD 83/NSRS 2007

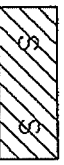
SITE 13

-  DENOTES IMPACTS IN SURFACE WATER
-  DENOTES TEMPORARY IMPACTS IN SURFACE WATER

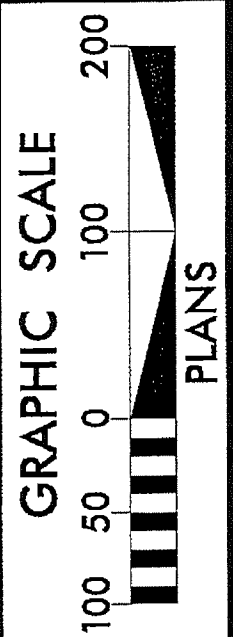
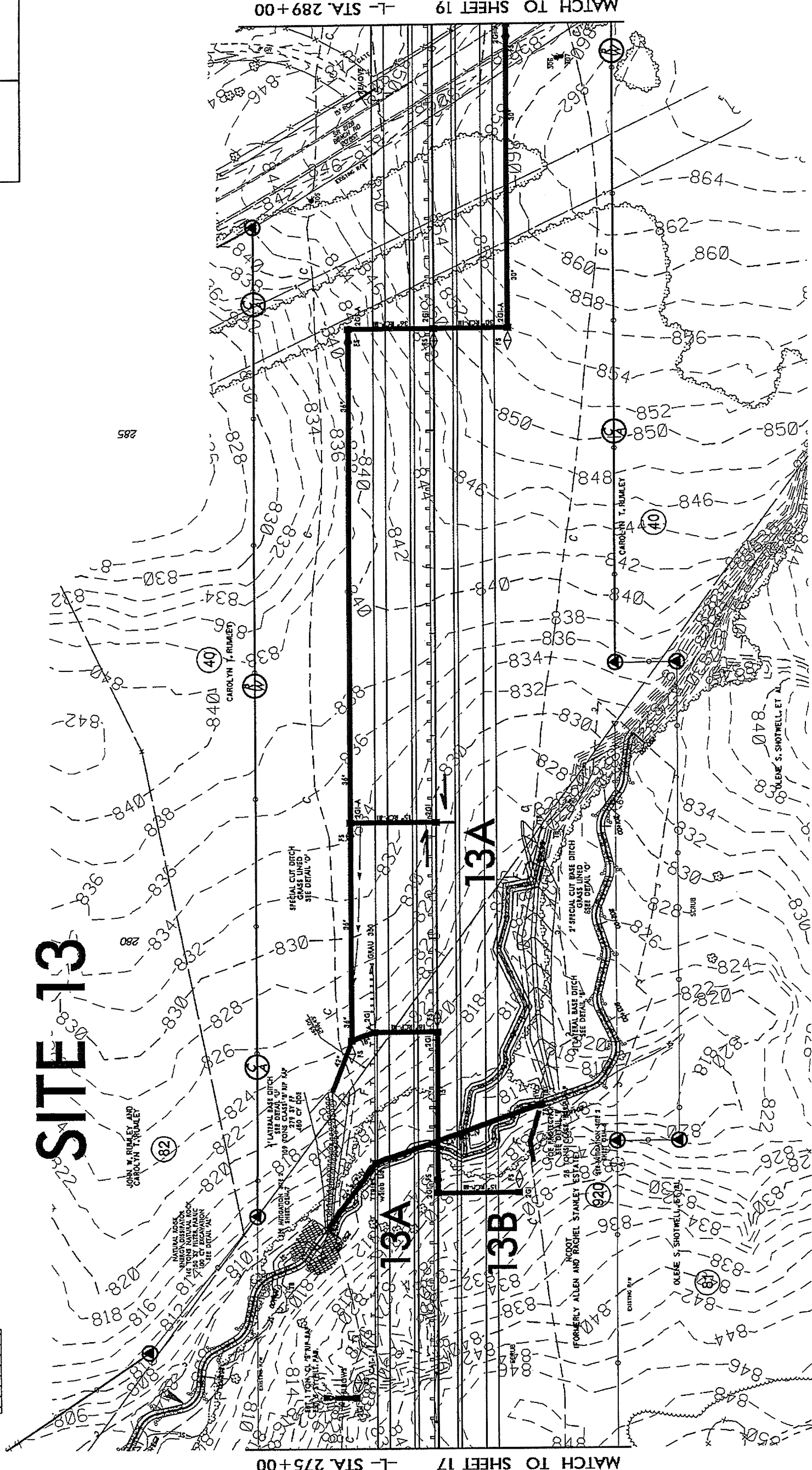

NO.	DESCRIPTION	DATE

R-2413A	18
BY SHEET NO. ROADWAY DESIGN ENGINEER	HYDRAULICS ENGINEER
PRELIMINARY PLANS DO NOT USE FOR CONSTRUCTION	

Permit Drawing 81
Sheet 43 of 81
MAD 8/ANSRS 2007

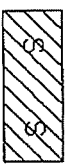
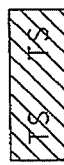
-  DENOTES IMPACTS IN SURFACE WATER
-  DENOTES TEMPORARY IMPACTS IN SURFACE WATER

SITE 13

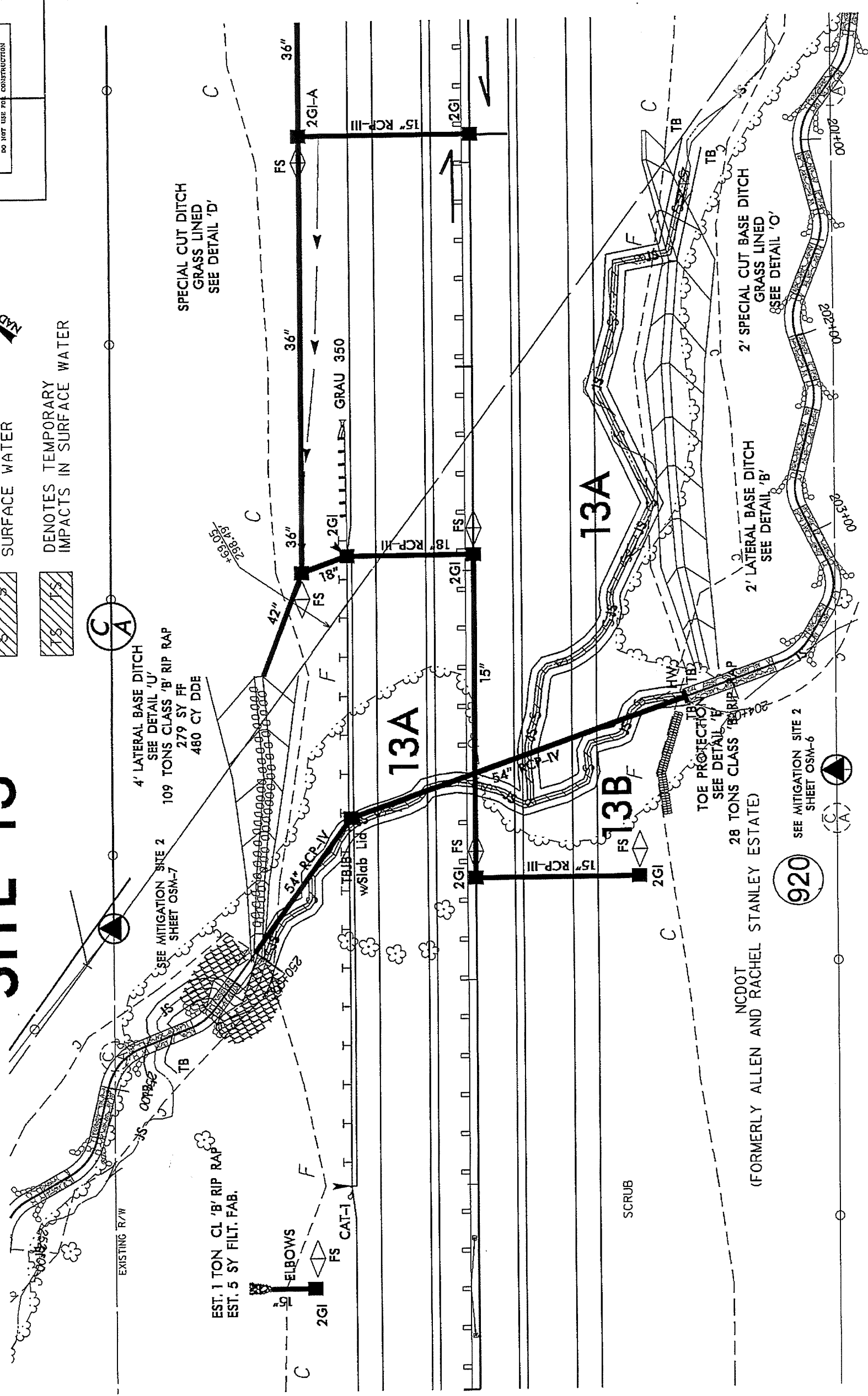

920

NCDOT
(FORMERLY ALLEN AND RACHEL STANLEY ESTATE)

SEE MITIGATION SITE 2
SHEET OSM-6

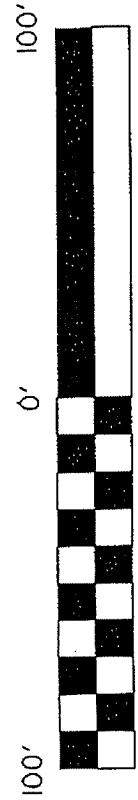



8/17/99

REVISIONS

PROJECT REFERENCE NO. R-2473A	SHEET NO. 20
ROADWAY DESIGN ENGINEER	HYDRAULICS ENGINEER
PRELIMINARY PLANS DO NOT USE FOR CONSTRUCTION	

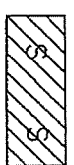
SITE 14

 DENOTES IMPACTS IN SURFACE WATER
 DENOTES TEMPORARY IMPACTS IN SURFACE WATER

Permit Drawing
 Sheet 44 of 81

NAD 83/NSRS 2007

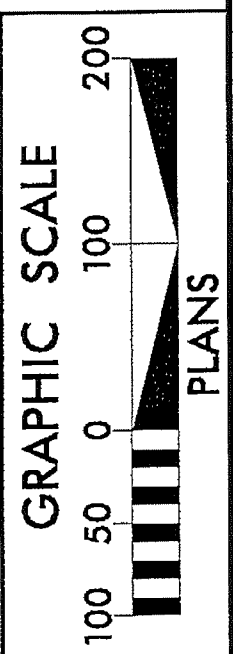
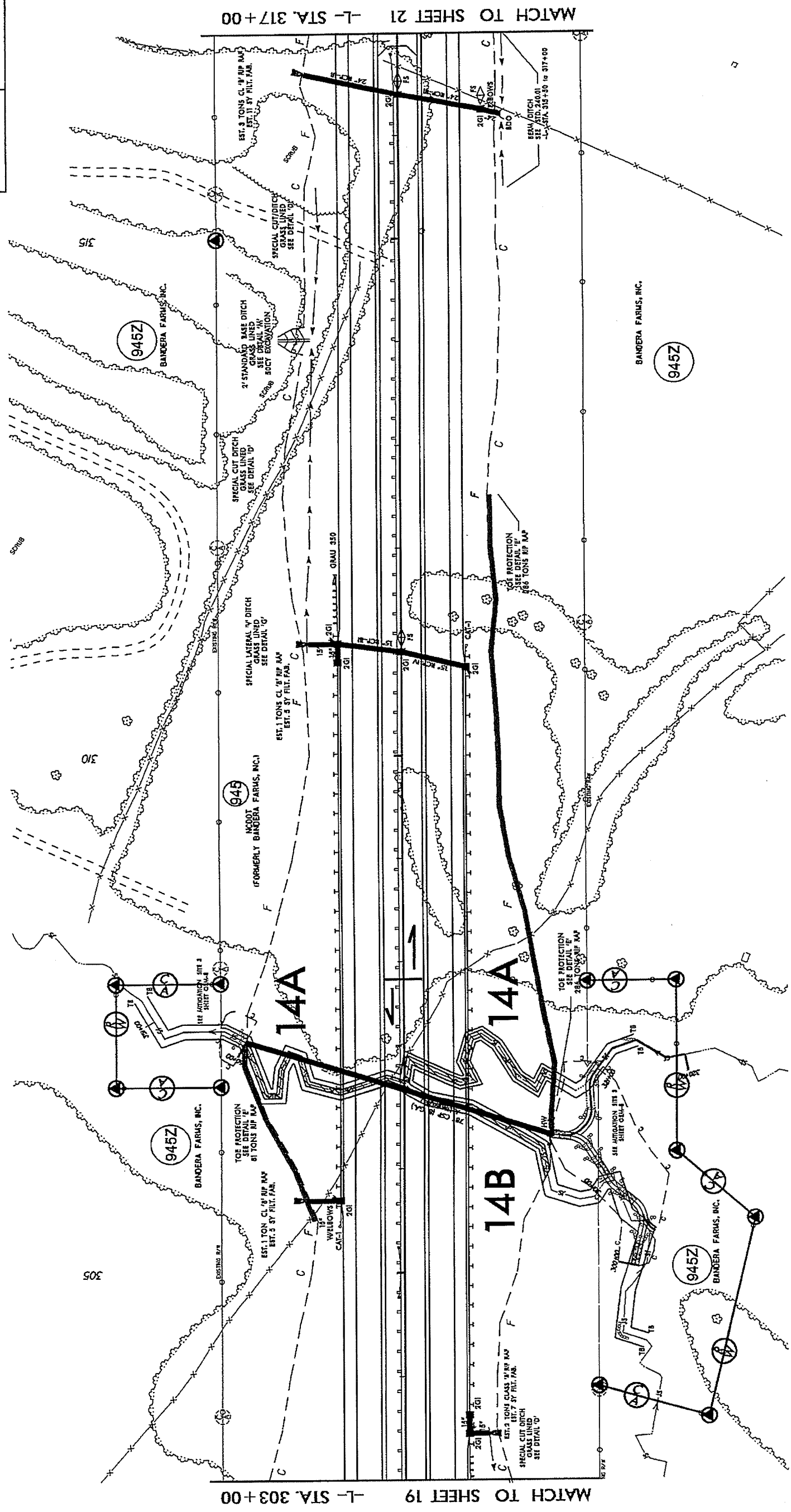



REVISIONS

Permit Drawing 81
Sheet 45 of 81

MAD 83/ANRS 2007

R-243A	20
RDW SHEET NO.	HYDRAULICS ENGINEER
ROADWAY DESIGN ENGINEER	
PRELIMINARY PLANS DO NOT USE FOR CONSTRUCTION	

-  DENOTES IMPACTS IN SURFACE WATER
-  DENOTES TEMPORARY IMPACTS IN SURFACE WATER

SITE 14

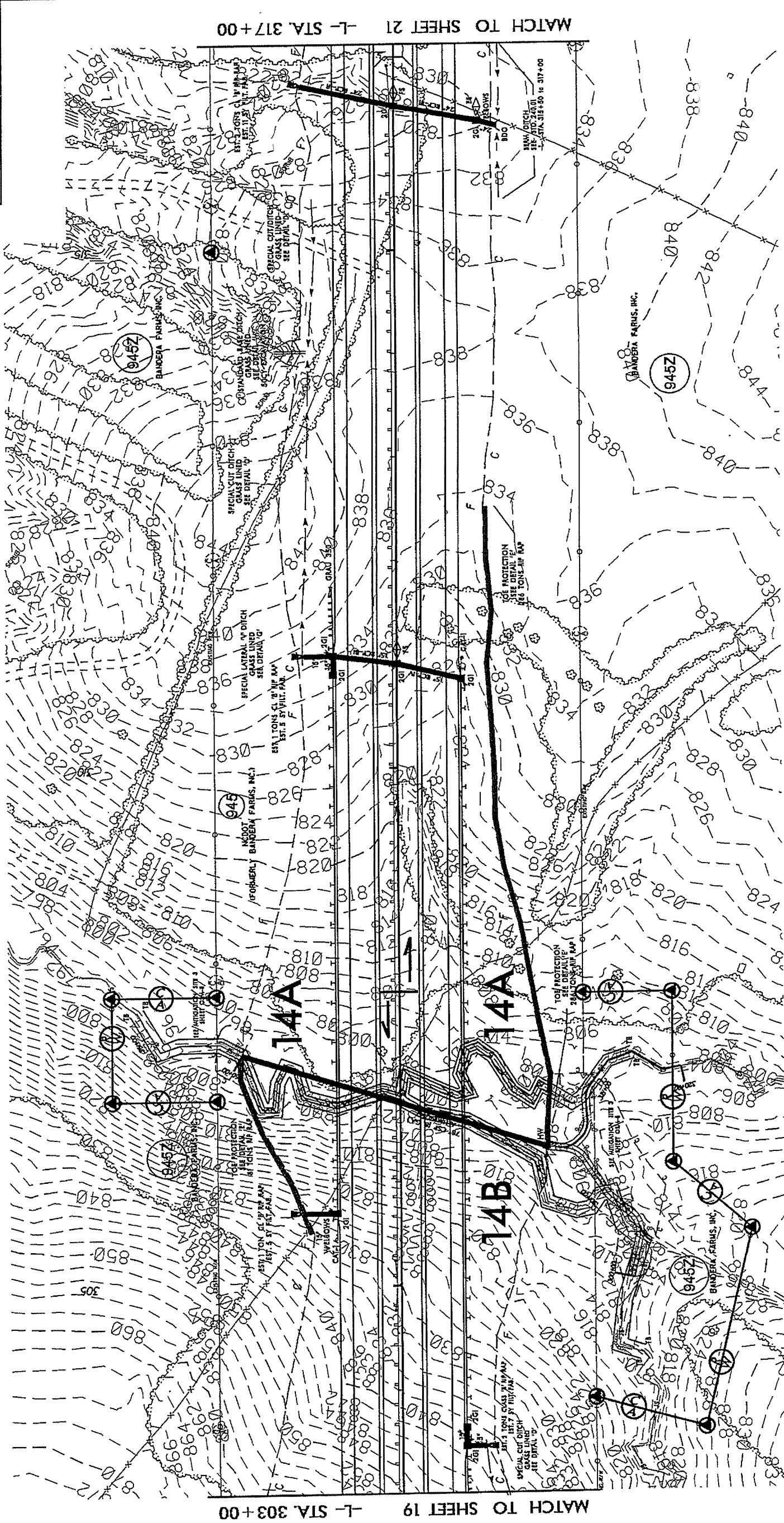

MATCH TO SHEET 21 -L- STA. 317+00

MATCH TO SHEET 19 -L- STA. 303+00

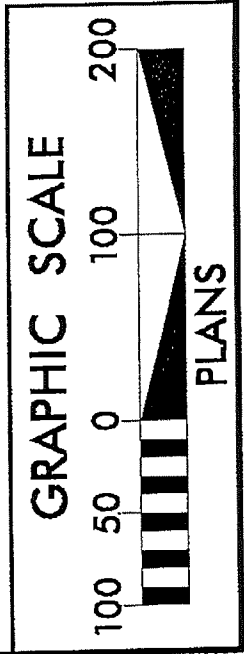

REVISIONS	

Permit Drawing
Sheet 46 of 81

PROJECT REFERENCE NO. R-243A	SHEET NO. 20
ROWAY DESIGN ENGINEER	HYDRAULICS ENGINEER
PRELIMINARY PLANS <small>DO NOT USE FOR CONSTRUCTION</small>	

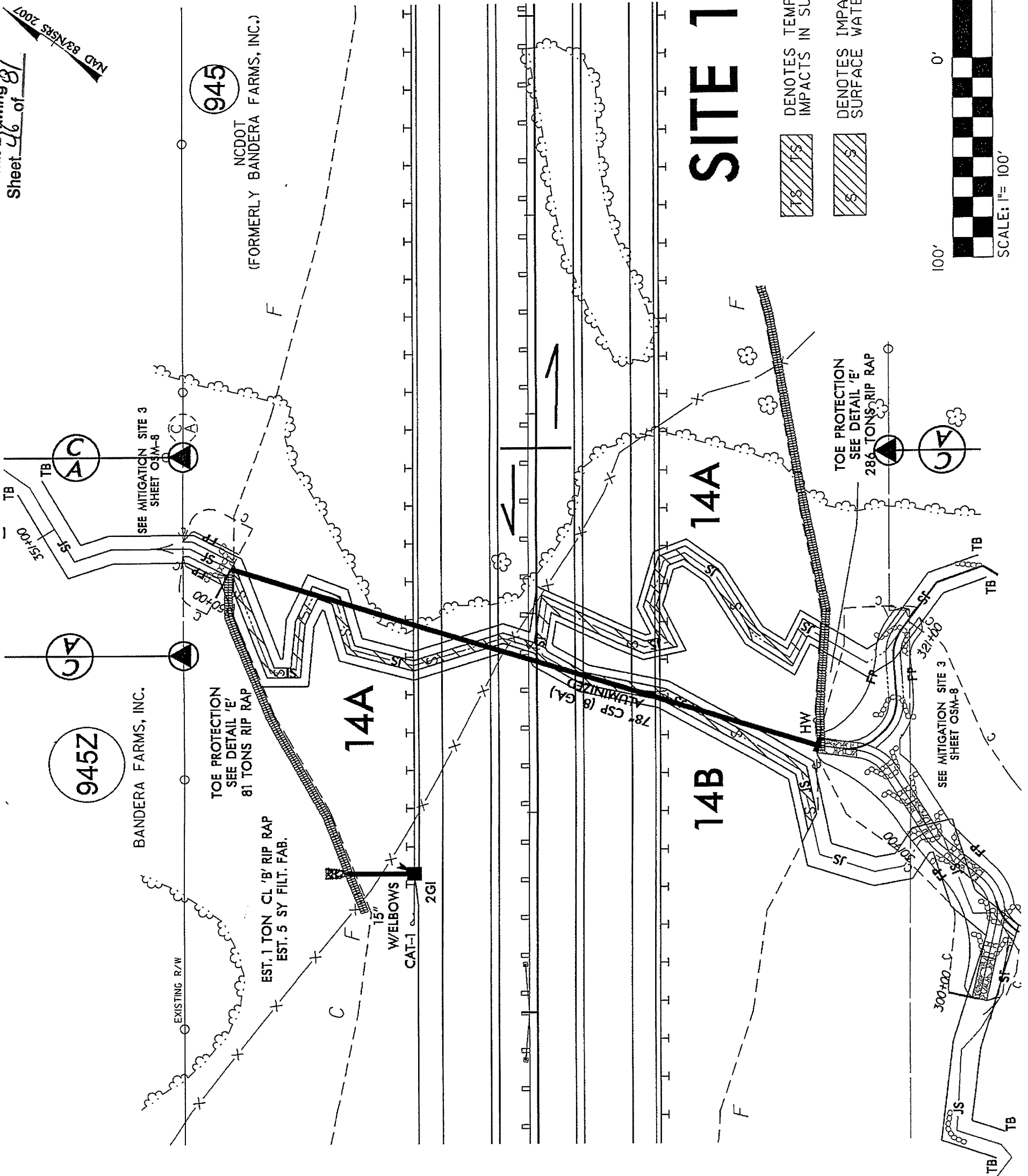

SITE 14

- DENOTES TEMPORARY IMPACTS IN SURFACE WATER
- DENOTES IMPACTS IN SURFACE WATER

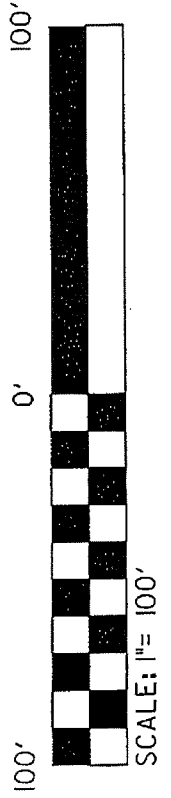

945Z

945

BANDERA FARMS, INC.

NCDOT
(FORMERLY BANDERA FARMS, INC.)

REVISIONS

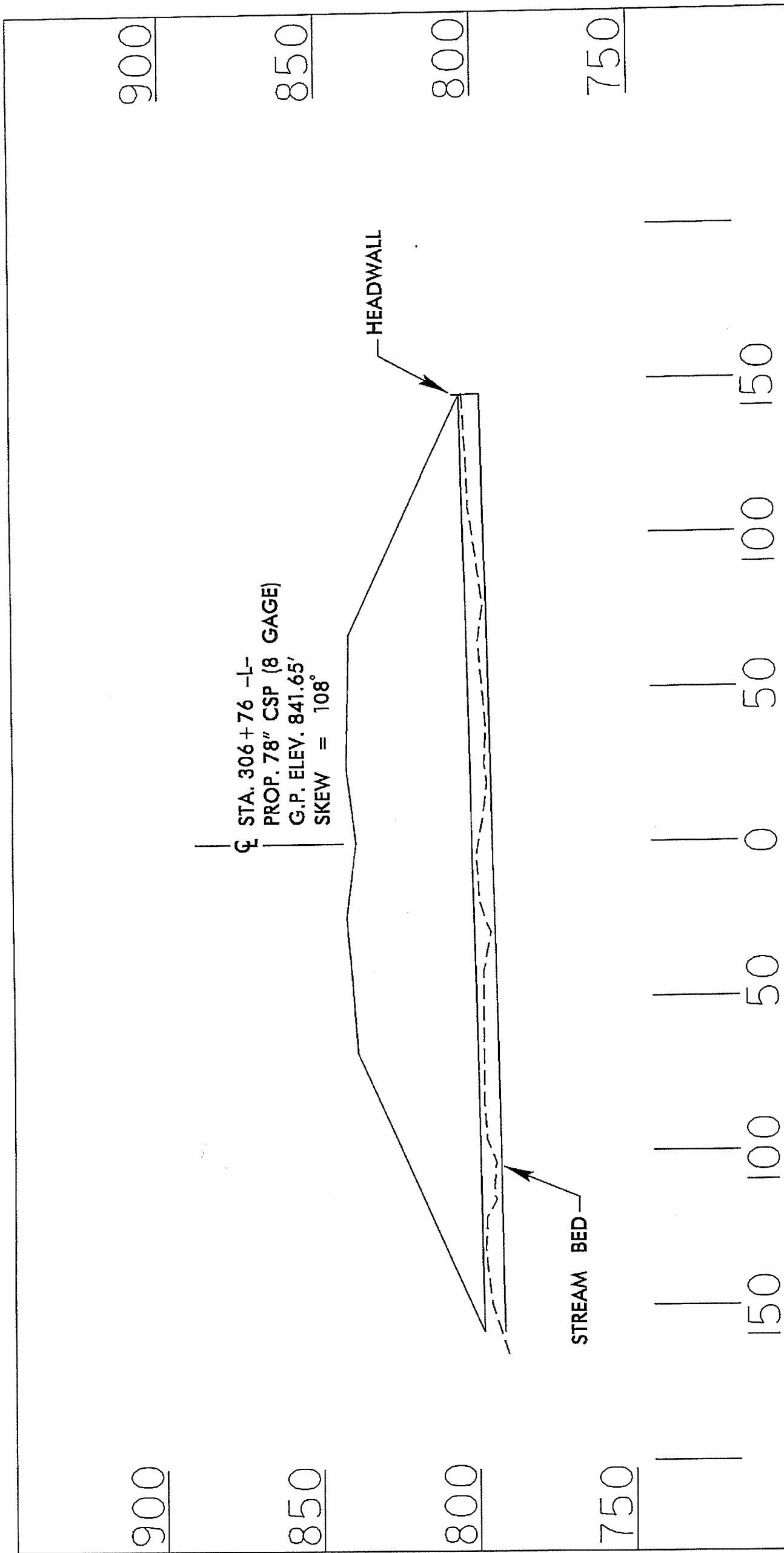

PROFILE

NCDOT
 DIVISION OF HIGHWAYS
 GUILFORD COUNTY
 PROJECT: 34429.1.1 (R-2413A)
 NC 68 CONNECTOR
 FROM FOUR LANES AT
 SR 2011 TO SR 2127

SHEET 47 OF 81

2 / 13 / 13

PROJECT REFERENCE NO. R-2413A
 SHEET NO. 21
 CIVIL SHEET NO.
 ROADWAY DESIGN ENGINEER
 HYDRAULICS ENGINEER
 PRELIMINARY PLANS
 DO NOT USE FOR CONSTRUCTION

Permit Drawing
 Sheet 48 of 61
 NAD BARNES 2007

SITE 15

SITE 16

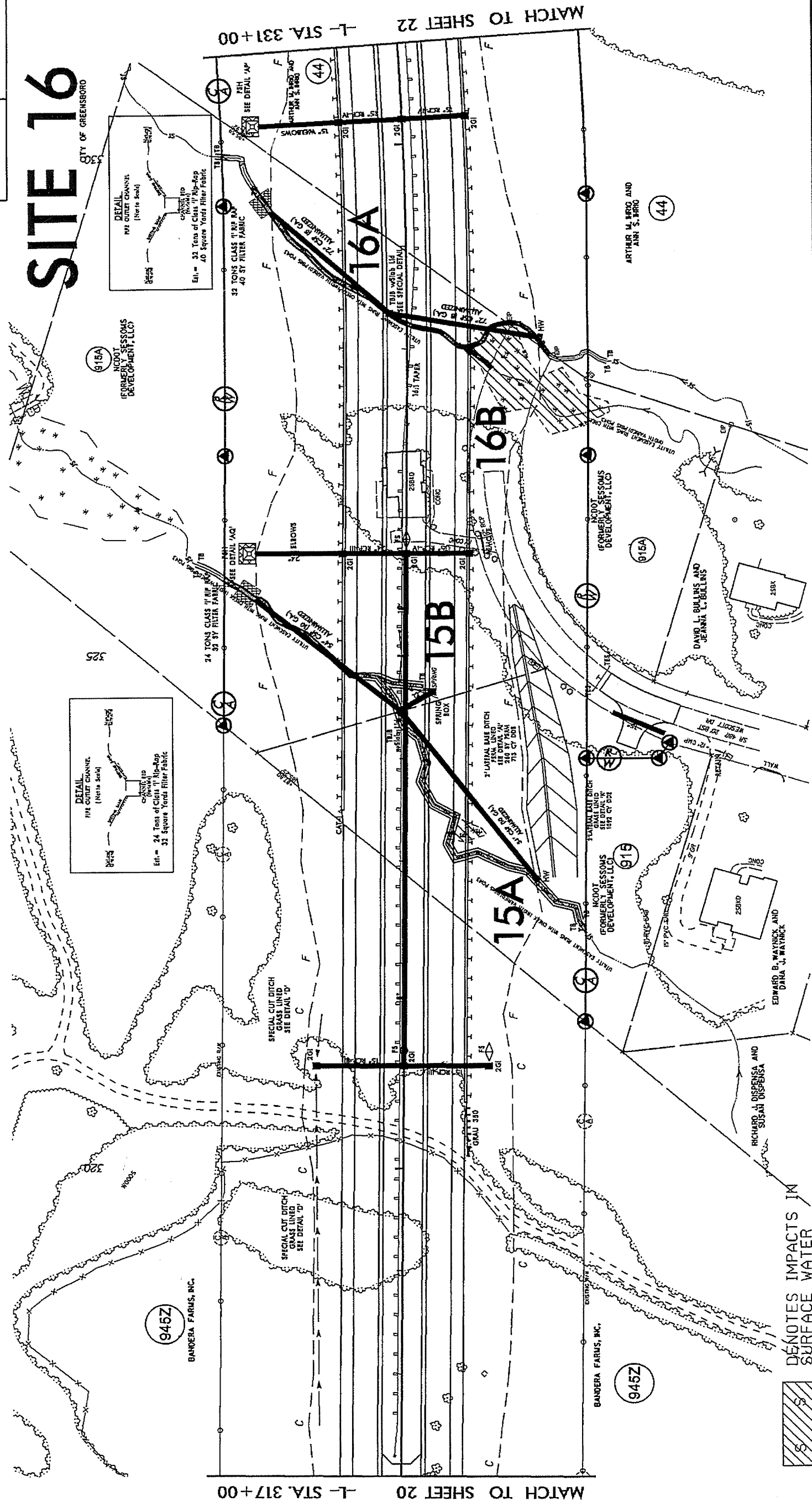

- DENOTES IMPACTS IN SURFACE WATER
- DENOTES TEMPORARY IMPACTS IN SURFACE WATER
- DENOTES FILL IN WETLAND

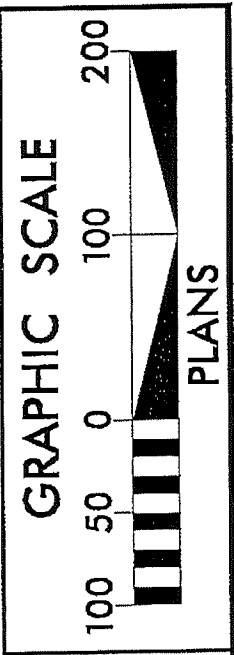

MATCH TO SHEET 20 - STA. 317+00

MATCH TO SHEET 22 - STA. 331+00

REVISIONS

NO.	DATE	DESCRIPTION

PROJECT REFERENCE NO. R-2413A
 SHEET NO. 21

BY SHEET NO. ROADWAY DESIGN ENGINEER
 HYDRAULICS ENGINEER

PRELIMINARY PLANS
 DO NOT USE FOR CONSTRUCTION

Permit Drawing 81
 Sheet 49 of 81

MAD 8/28/98 2007

SITE 15

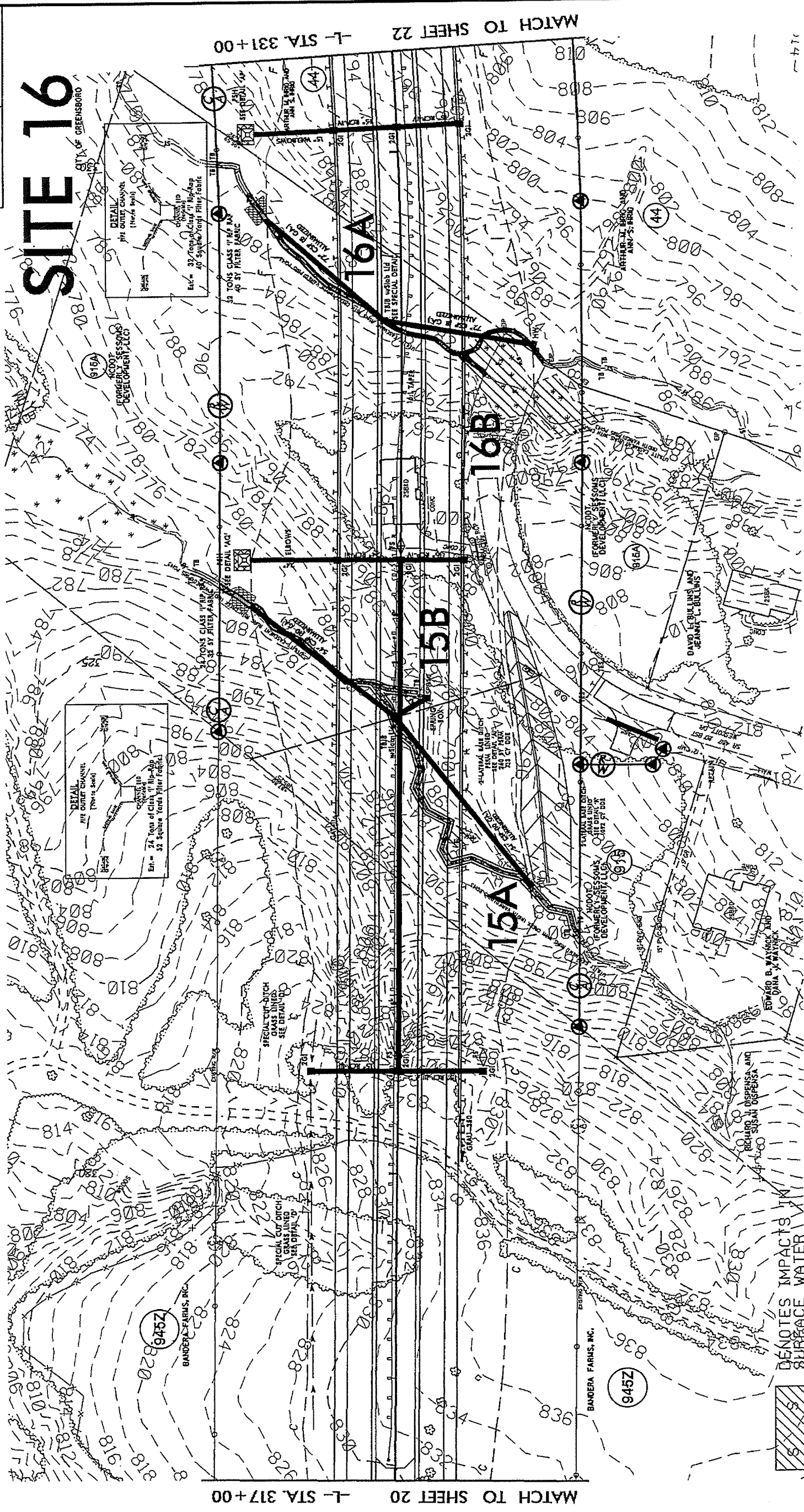

- DENOTES IMPACTS IN SURFACE WATER
- DENOTES TEMPORARY IMPACTS IN SURFACE WATER
- DENOTES FILL IN WETLAND



GRAPHIC SCALE
 100 50 0 100 200

PLANS

REVISIONS

PROJECT REFERENCE NO. R-24/3A	SHEET NO. 21
RDW SHEET NO. ROADWAY DESIGN ENGINEER	HYDRAULICS ENGINEER
PRELIMINARY PLANS DO NOT USE FOR CONSTRUCTION	

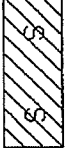
Permit Drawing 01
Sheet 30 of 61

 DENOTES IMPACTS IN SURFACE WATER
 DENOTES TEMPORARY IMPACTS IN SURFACE WATER
 DENOTES FILL IN WETLAND

SITE 15

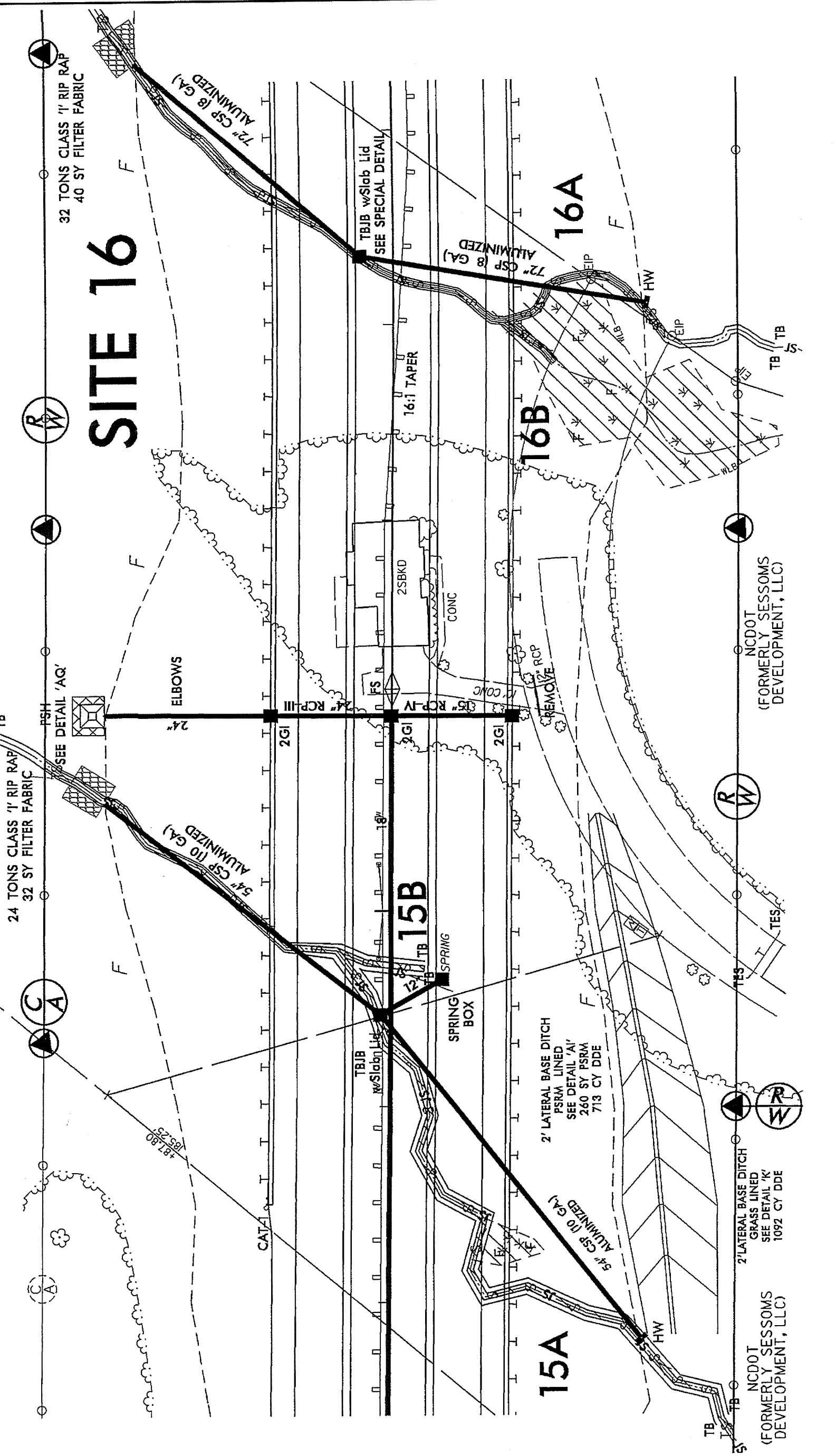
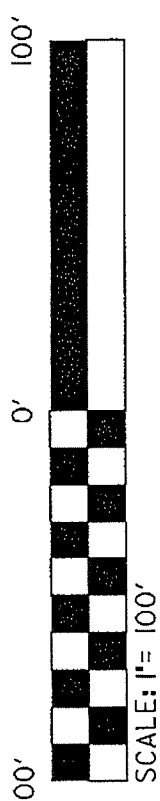

NCDOT
(FORMERLY SESSOMS
DEVELOPMENT, LLC)

NCDOT
(FORMERLY SESSOMS
DEVELOPMENT, LLC)

REVISIONS

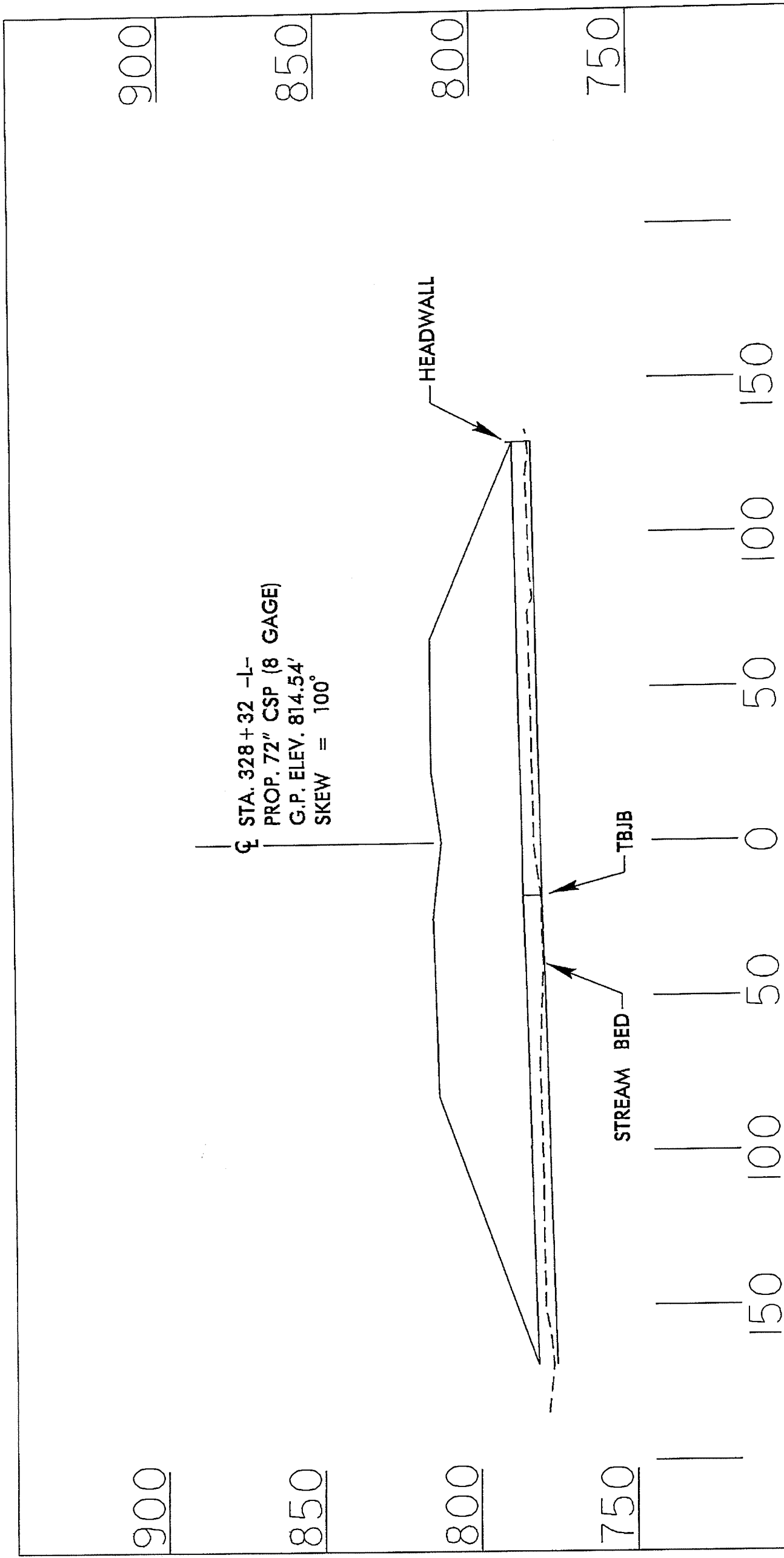

PROFILE

NCDOT
 DIVISION OF HIGHWAYS
 GUILFORD COUNTY
 PROJECT: 34429.1.1 (R-2413A)
 NC 68 CONNECTOR
 FROM FOUR LANES AT
 SR 2011 TO SR 2127

PROJECT REFERENCE NO. R-2413A
 SHEET NO. 22
 ROADWAY DESIGN ENGINEER
 HYDRAULICS ENGINEER
PRELIMINARY PLANS
 DO NOT USE FOR CONSTRUCTION

Permit Drawing 81
 Sheet 53 of 81
 MAY 23 2007

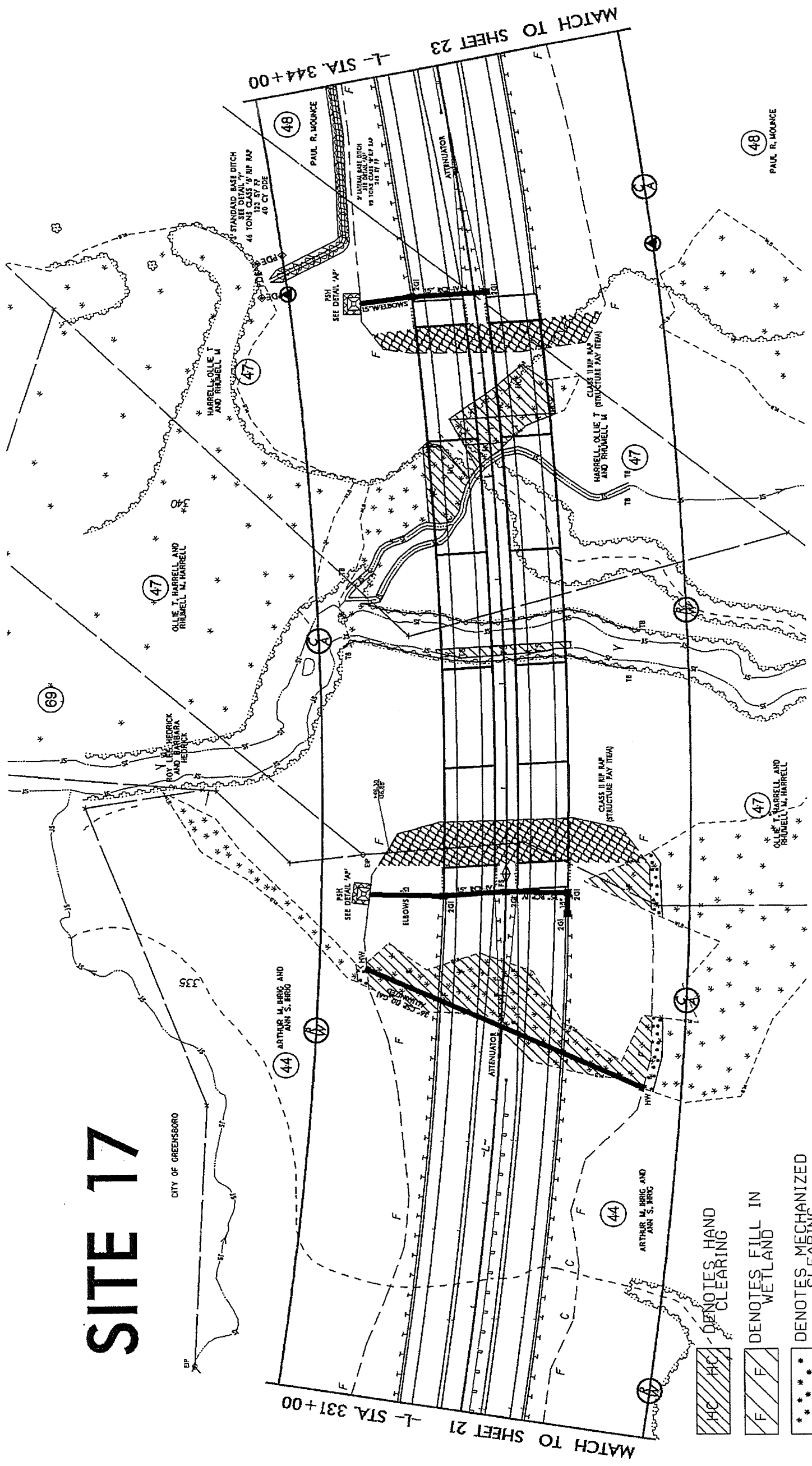
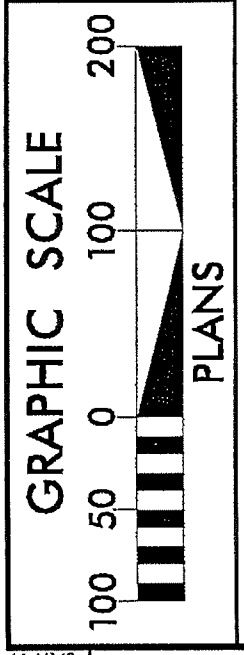

SITE 17

SITE 18

- DENOTES HAND CLEARING
- DENOTES FILL IN WETLAND
- DENOTES MECHANIZED CLEARING
- DENOTES TEMPORARY IMPACTS IN SURFACE WATER
- DENOTES TEMPORARY FILL IN WETLAND

R/W REVISION: PARCEL NUMBER 45 HAS BEEN CHANGED TO PARCEL NUMBER 47. PARCEL 45 HAS BEEN COMBINED WITH PARCEL 47. CEH 2/27/13.

REVISIONS

PROJECT REFERENCE NO. R-2413A
 SHEET NO. 22
 ROADWAY DESIGN ENGINEER
 HYDRAULICS ENGINEER
PRELIMINARY PLANS
 DO NOT USE FOR CONSTRUCTION

Permit Drawing Sheet 54 of 81
 07/25/07
 07/25/07

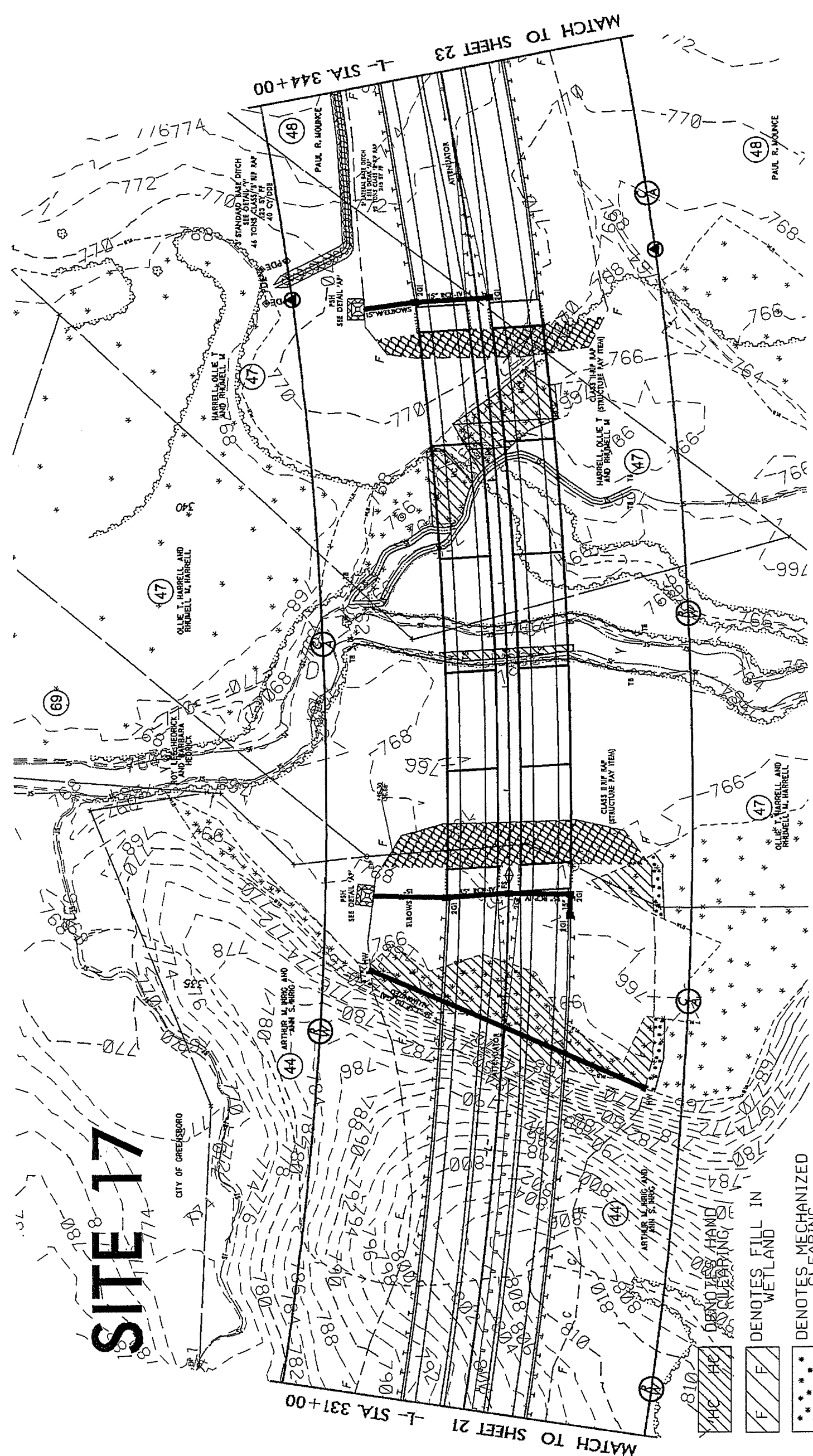
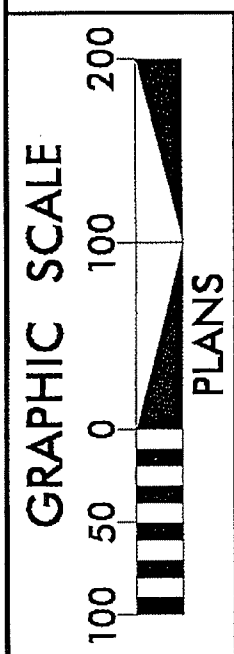

SITE 18

- DENOTES FILL IN WETLAND
- DENOTES FILL IN WETLAND
- DENOTES MECHANIZED CLEARING
- DENOTES TEMPORARY IMPACTS IN SURFACE WATER
- DENOTES TEMPORARY FILL IN WETLAND

R/W REVISION: PARCEL NUMBER 45 HAS BEEN CHANGED TO PARCEL NUMBER 47. PARCEL 45 HAS BEEN COMBINED WITH PARCEL 47. CEH 2/27/13.

REVISIONS

Permit Drawing
 Sheet 55 of 57

PROJECT REFERENCE NO. R-243A
 HWY. SHEET NO. 22
 ROADWAY DESIGN ENGINEER
 HYDRAULICS ENGINEER
 PRELIMINARY PLANS
 DO NOT USE FOR CONSTRUCTION

SITE 17

44 ARTHUR M. IHRIG AND ANN S. IHRIG

R/W

PSH SEE DETAIL 'AP'

ELBOWS

ATTENUATOR

2GI

2GI

2GI

2GI

2GI

2GI

2GI

2GI

2GI

2GI

CLASS II RIP RAP (STRUCTURE PAY ITEM)

C/A

- HC DENOTES HAND CLEARING
- F DENOTES FILL IN WETLAND
- *** DENOTES MECHANIZED CLEARING
- TS DENOTES TEMPORARY IMPACTS IN SURFACE WATER
- T DENOTES TEMPORARY FILL IN WETLAND

+46.30
 36" ALUMINIZED CSP (10 GA)

HW

HW

HW

HW

HW

HW

HW

HW

HW

HW

HW

HW

HW

HW

HW

HW

HW

HW

HW

HW

HW

HW

HW

HW

HW

HW

HW

HW

HW

HW

HW

HW

HW

HW

HW

HW

HW

HW

HW

HW

HW

HW

HW

HW

HW

HW

HW

HW

HW

HW

HW

HW

HW

HW

HW

HW

HW

HW

HW

HW

HW

HW

HW

HW

HW

HW

HW

HW

HW

HW

HW

HW

HW

HW

HW

HW

HW

HW

HW

HW

HW

HW

HW

HW

HW

HW

HW

HW

HW

HW

HW

HW

HW

HW

HW

HW

HW

HW

HW

HW

HW

HW

HW

HW

HW

HW

HW

HW

HW

HW

HW

HW

HW

HW

HW

HW

HW

HW

HW

HW

HW

HW

HW

HW

HW

HW

HW

HW

HW

HW

HW

HW

HW

HW

HW

HW

HW

HW

HW

HW

HW

HW

HW

HW

HW

HW

HW

HW

HW

HW

HW

HW

HW

HW

HW

HW

HW

HW

HW

HW

HW

HW

HW

HW

HW

HW

HW

HW

HW

HW

HW

HW

HW

HW

HW

HW

HW

HW

HW

HW

HW

HW

HW

HW

HW

HW

HW

HW

HW

HW

HW

HW

HW

HW

HW

HW

HW

HW

HW

HW

HW

HW

HW

HW

HW

HW

HW

HW

HW

HW

HW

HW

HW

HW

HW

HW

HW

HW

HW

HW

HW

HW

HW

HW

HW

HW

HW

HW

HW

HW

HW

HW

HW

HW

HW

HW

SITE 18

HARRELL, OLLIE T (STRUCTURE) AND RHUMELL M

47

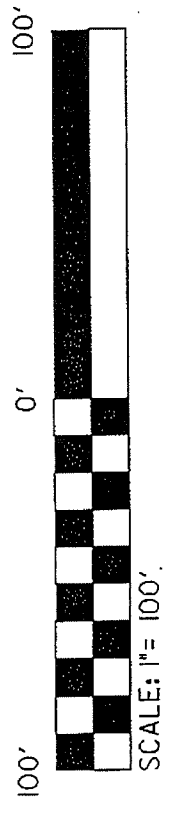

REVISIONS

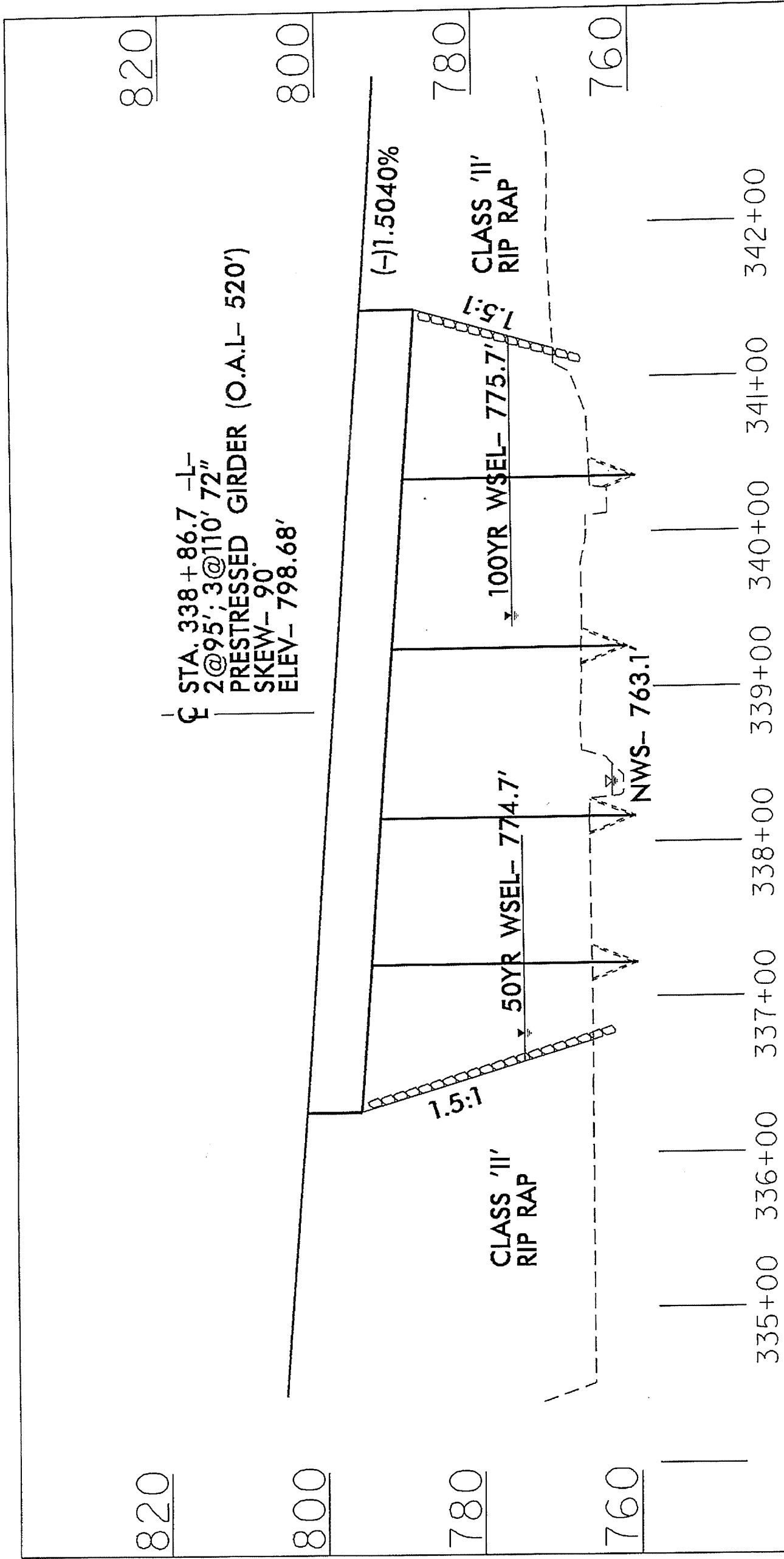

PROFILE

NCDOT
 DIVISION OF HIGHWAYS
 GUILFORD COUNTY
 PROJECT: 34429.1.1 (R-2413A)
 NC 68 CONNECTOR
 FROM FOUR LANES AT
 SR 2011 TO SR 2127

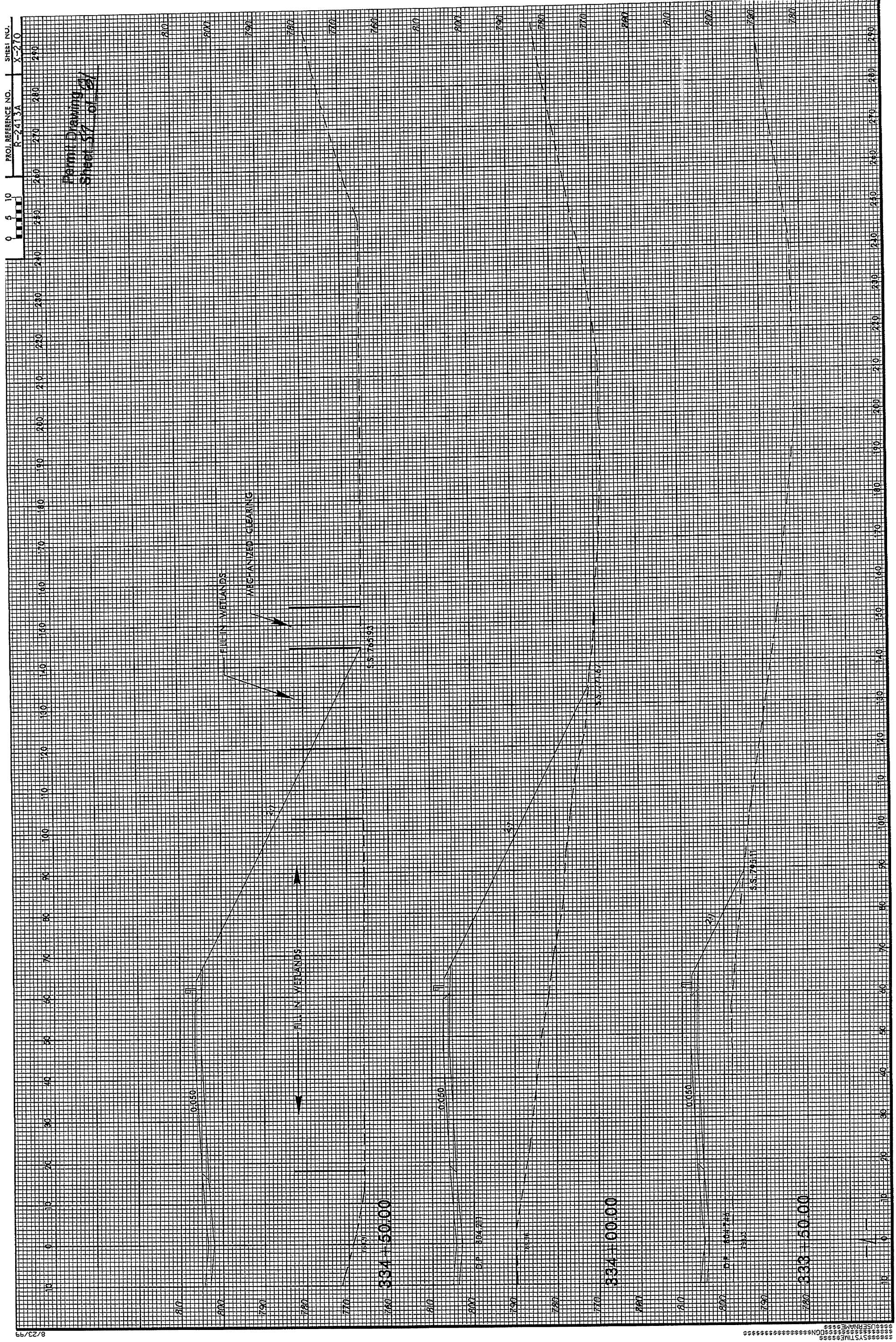

8/23/93
 SYSTEMS TIME 8:55
 USFERNAMES

PROJECT REFERENCE NO. R-2413A	SHEET NO. 23
ROADWAY DESIGN ENGINEER	HYDRAULICS ENGINEER
PRELIMINARY PLANS DO NOT USE FOR CONSTRUCTION	

Permit Drawing 81
Sheet 60 of 70
AND SEVERALS 2007

SITE 19

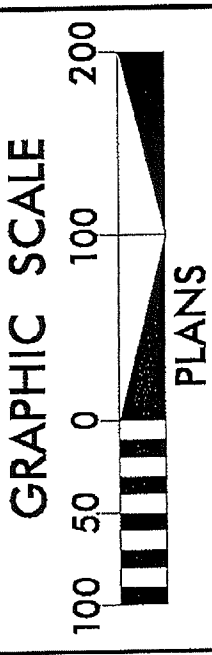
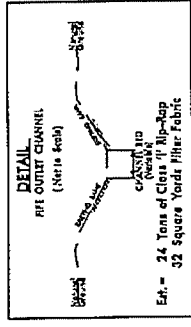
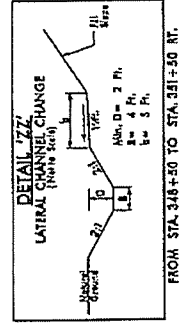
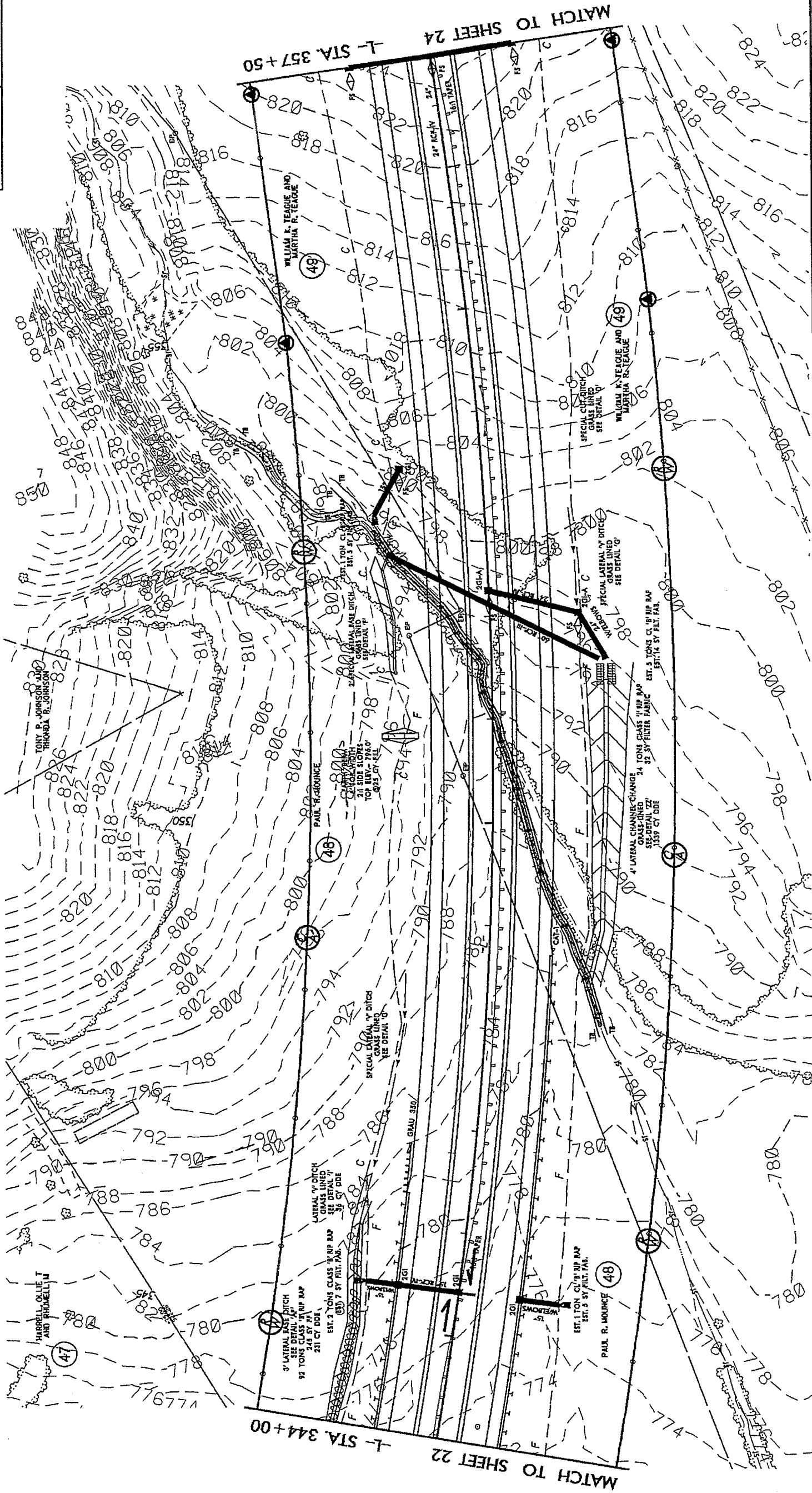



REVISIONS

Permit Drawing
Sheet 61 of 81

PROJECT REFERENCE NO.	R-243A	SHEET NO.	23
ENGINEER	ROADWAY DESIGN ENGINEER	HYDRAULICS ENGINEER	
PRELIMINARY PLANS DO NOT USE FOR CONSTRUCTION			

SITE 19

-  DENOTES IMPACTS IN SURFACE WATER
-  DENOTES TEMPORARY IMPACTS IN SURFACE WATER

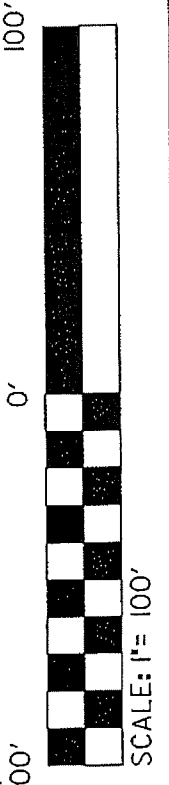
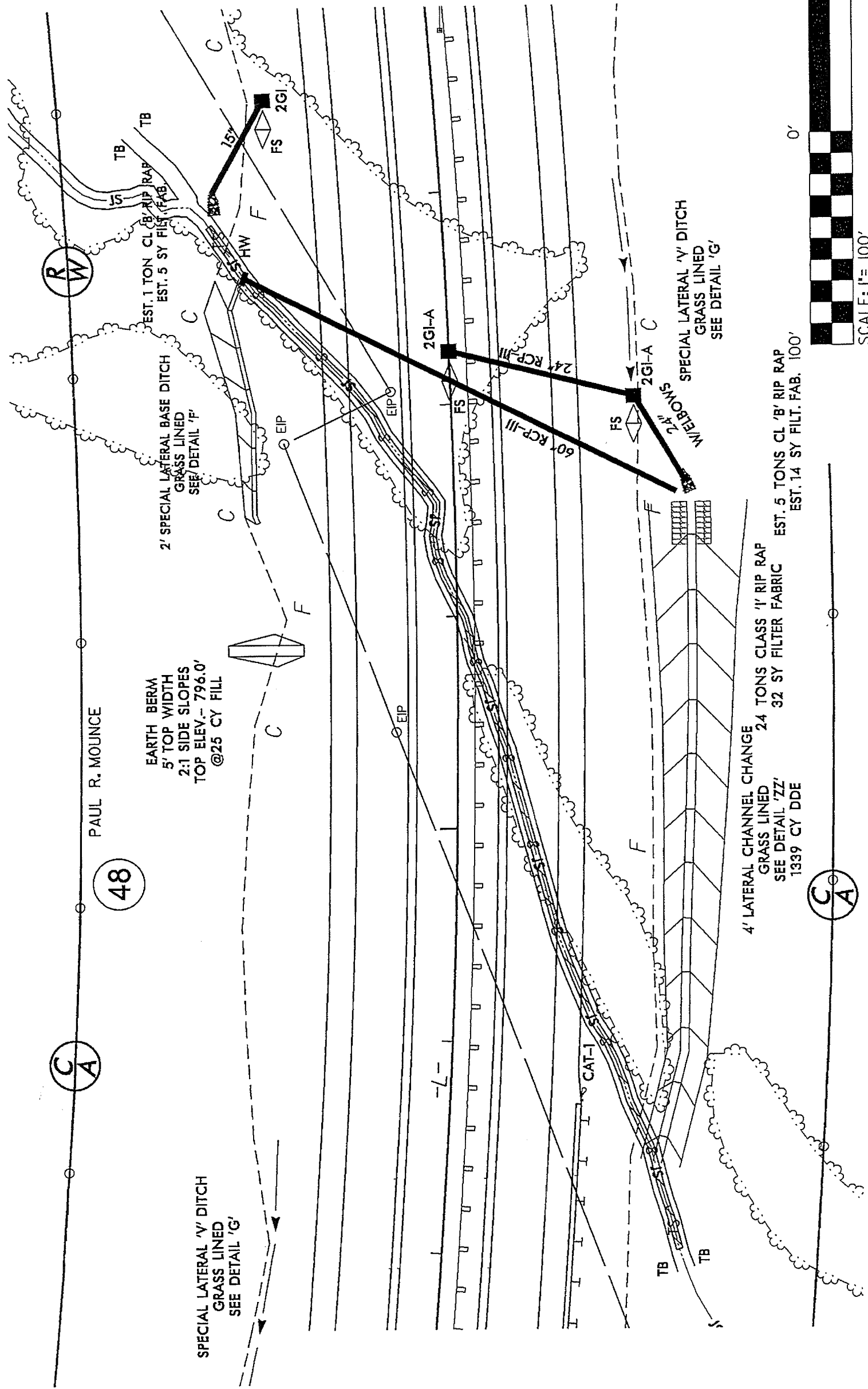

8/17/99

REVISIONS

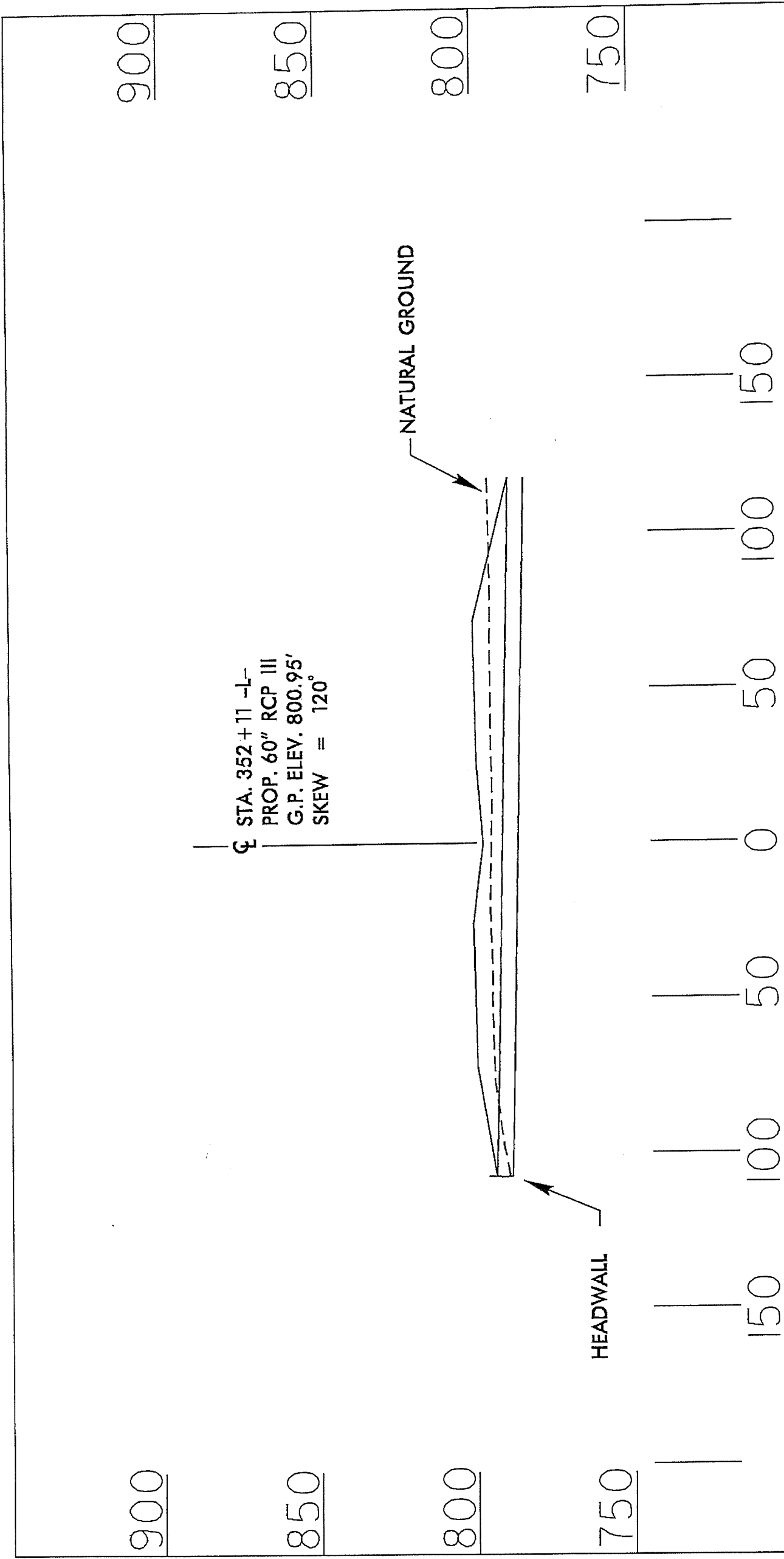

PROFILE

NCDOT
 DIVISION OF HIGHWAYS
 GUILFORD COUNTY
 PROJECT: 34429.1.1 (R-2413A)
 NC 68 CONNECTOR
 FROM FOUR LANES AT
 SR 2011 TO SR 2127

R-243A	31
HW SHEET NO.	HYDRAULICS ENGINEER
ROADWAY DESIGN ENGINEER	
PRELIMINARY PLANS <small>DO NOT USE FOR CONSTRUCTION</small>	

 DENOTES IMPACTS IN SURFACE WATER
 DENOTES FILL IN WETLAND

SITE 20

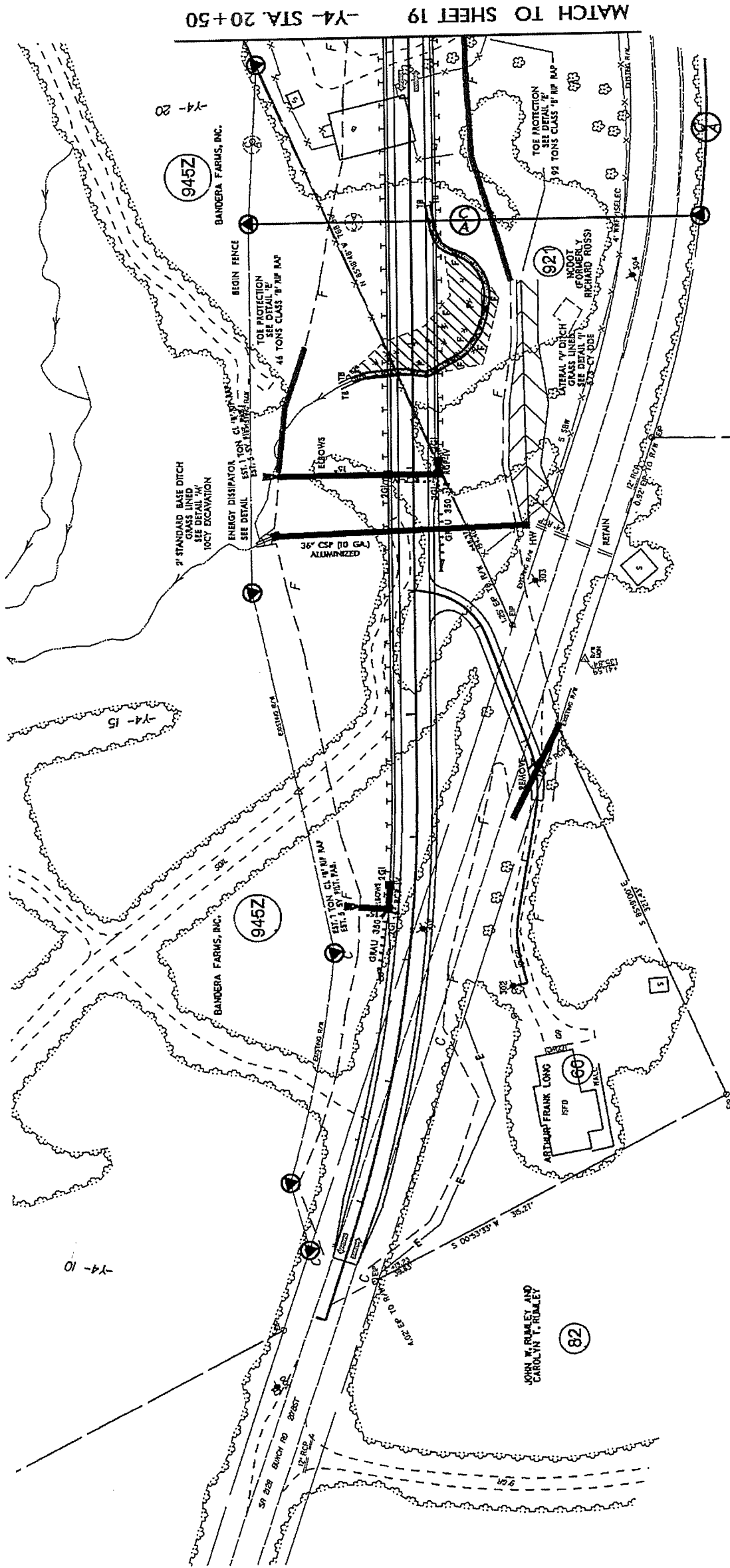

MATCH TO SHEET 19 -Y4- STA 20+50

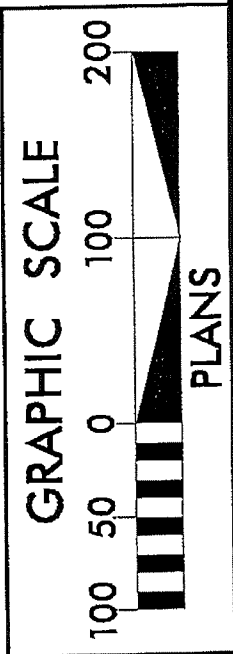

(40)
CAROLYN T. RUMLEY

JOHN W. RUMLEY AND
CAROLYN T. RUMLEY

Permit Drawing
 Sheet 04 of 81

SITE 20

DENOTES IMPACTS IN
 SURFACE WATER

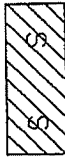

DENOTES FILL IN
 WETLAND

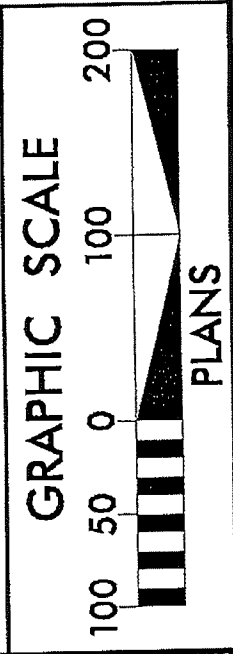
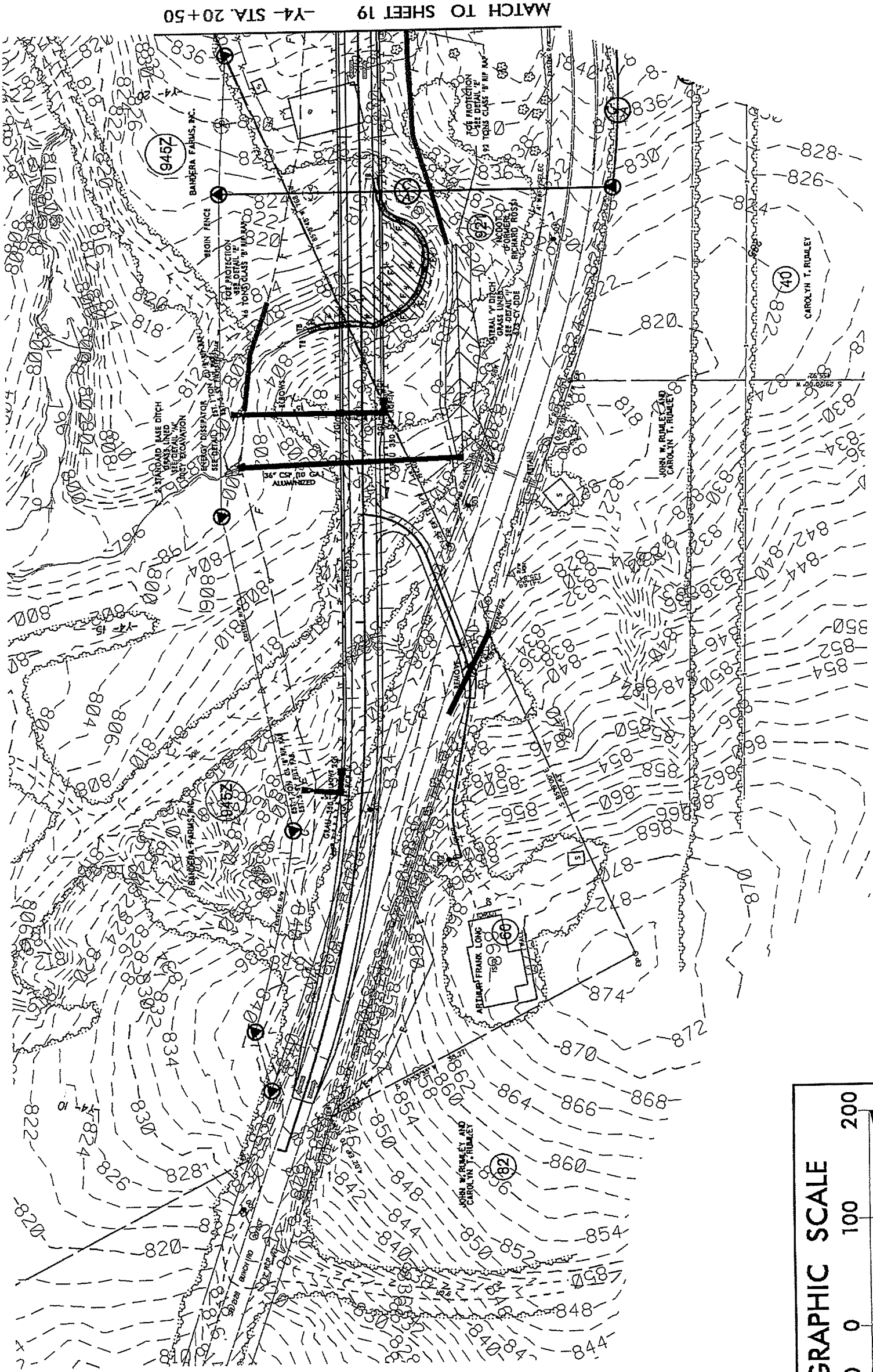

8/17/99

REVISIONS

R-243A	3/
RDW SHEET NO. ROADWAY DESIGN ENGINEER	HYDRAULICS ENGINEER
PRELIMINARY PLANS DO NOT USE FOR CONSTRUCTION	

MADE 8/24/85 2007

Permit Drawing
Sheet 65 of 81

SITE 20

 DENOTES IMPACTS IN SURFACE WATER
 DENOTES FILL IN WETLAND

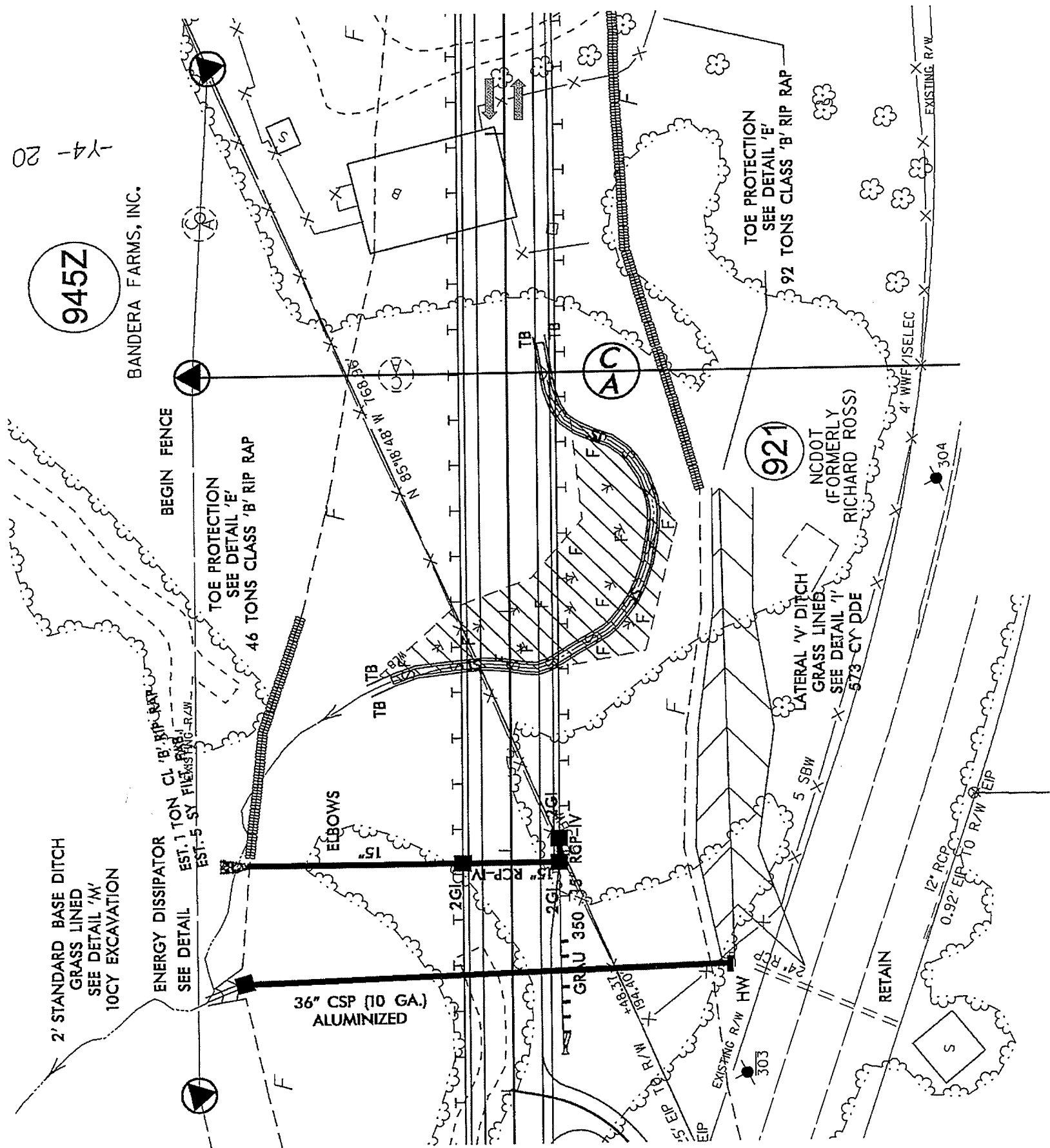
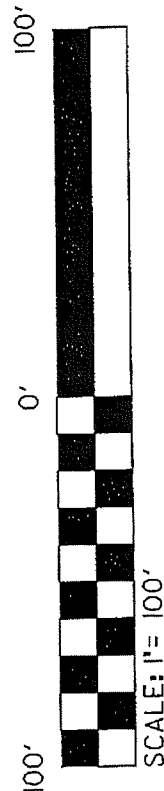

-Y4-20

945Z

BANDERA FARMS, INC.

921

NC DOT
(FORMERLY
RICHARD ROSS)

573-CY DDE

36" CSP (10 GA.)
ALUMINIZED

SEE DETAIL 'E'

SEE DETAIL 'E'

SEE DETAIL 'E'

SEE DETAIL 'I'

SEE DETAIL 'M'

SEE DETAIL 'N'

8/17/99

REVISIONS

*****SYSTEMTIME*****
*****FROM*****
*****DOWNS*****

ENGINEER, REGISTERED CIVIL ENGINEER
 R-2413A
 HW SHEET NO.
 ROADWAY DESIGN ENGINEER

34

HYDRAULICS ENGINEER

PRELIMINARY PLANS
 DO NOT USE FOR CONSTRUCTION

Permit Drawing
 Sheet 07 of 81
 NAD 83/NSRS 2007

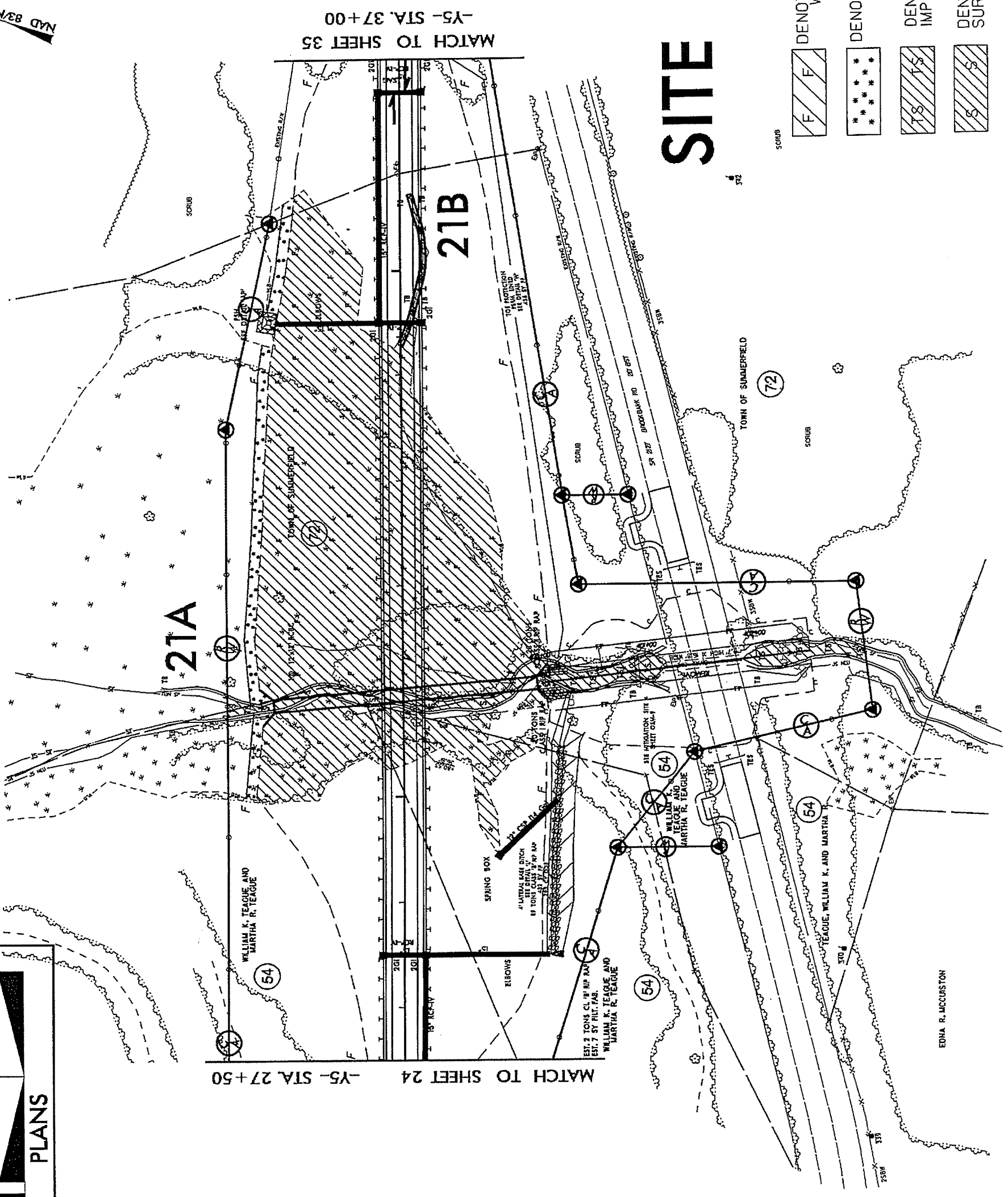
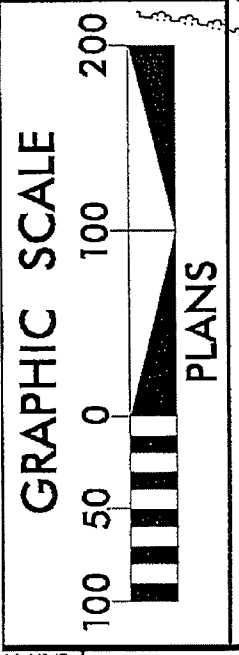

- DENOTES FILL IN WETLAND
- DENOTES MECHANIZED CLEARING
- DENOTES TEMPORARY IMPACTS IN SURFACE WATER
- DENOTES IMPACTS IN SURFACE WATER

SITE 21

REVISIONS

R/W REVISION: PARCEL NUMBER 53 HAS BEEN CHANGED TO PARCEL NUMBER 54. CEH 1/23/2013

DESIGN REVISION: THE VERTICAL ALIGNMENT FOR -Y5- HAS BEEN REVISED. JLT 1/28/2013

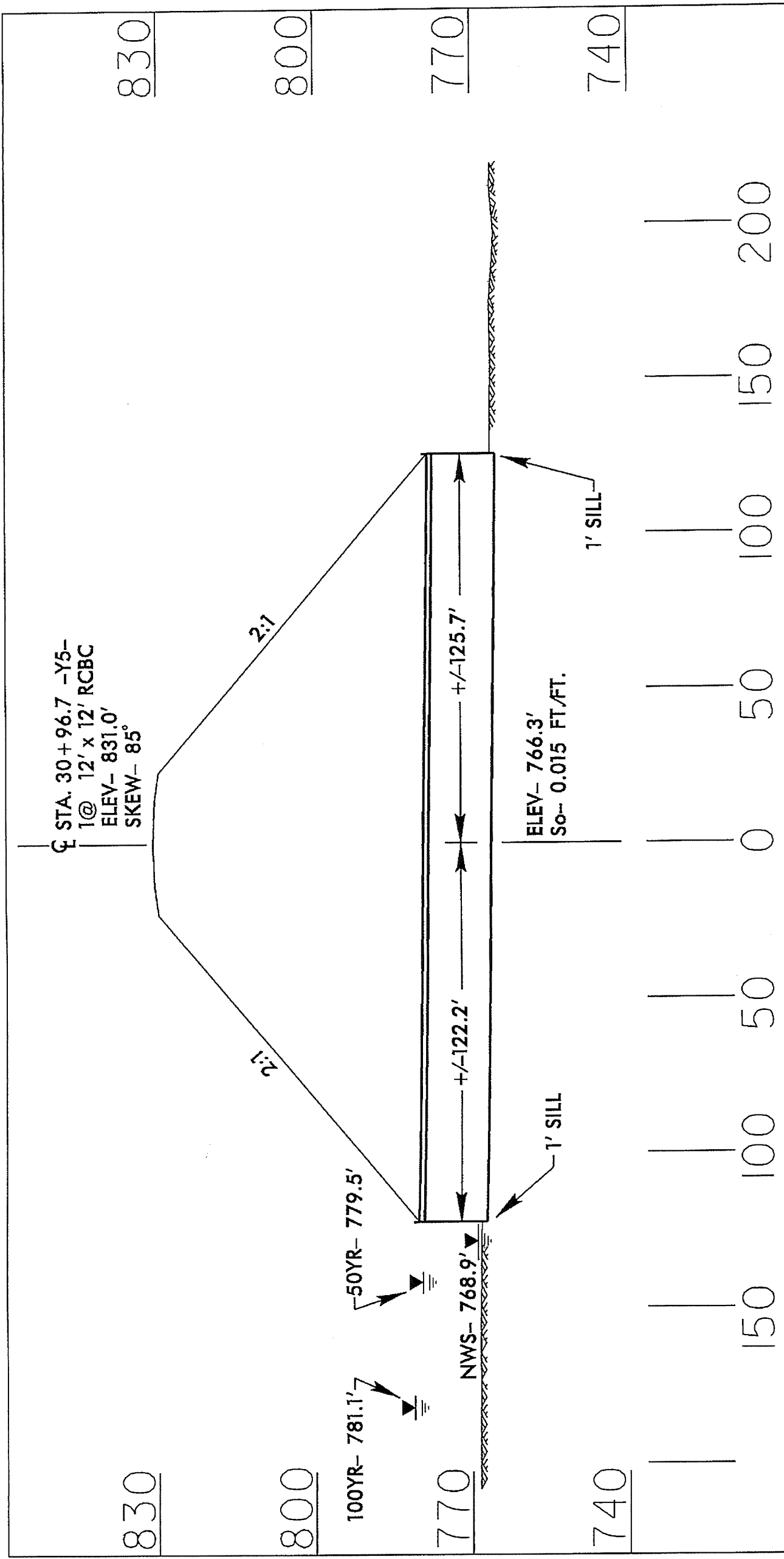



PROFILE

NCDOT
 DIVISION OF HIGHWAYS
 GUILFORD COUNTY
 PROJECT: 34429.1.1 (R-2413A)
 NC 68 CONNECTOR
 FROM FOUR LANES AT
 SR 2011 TO SR 2127

Permit Drawing
Sheet 73 of 81

NAD 83/NGS 2007

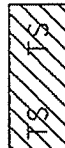
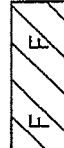
PROJECT REFERENCE NO. R-24/3A	SHEET NO. 37
ROADWAY DESIGN ENGINEER R.W. SHEET INC.	HYDRAULICS ENGINEER R.W. SHEET INC.
PRELIMINARY PLANS DO NOT USE FOR CONSTRUCTION	

-  DENOTES IMPACTS IN SURFACE WATER
-  DENOTES TEMPORARY IMPACTS IN SURFACE WATER
-  DENOTES FILL IN WETLAND
-  DENOTES MECHANIZED CLEARING

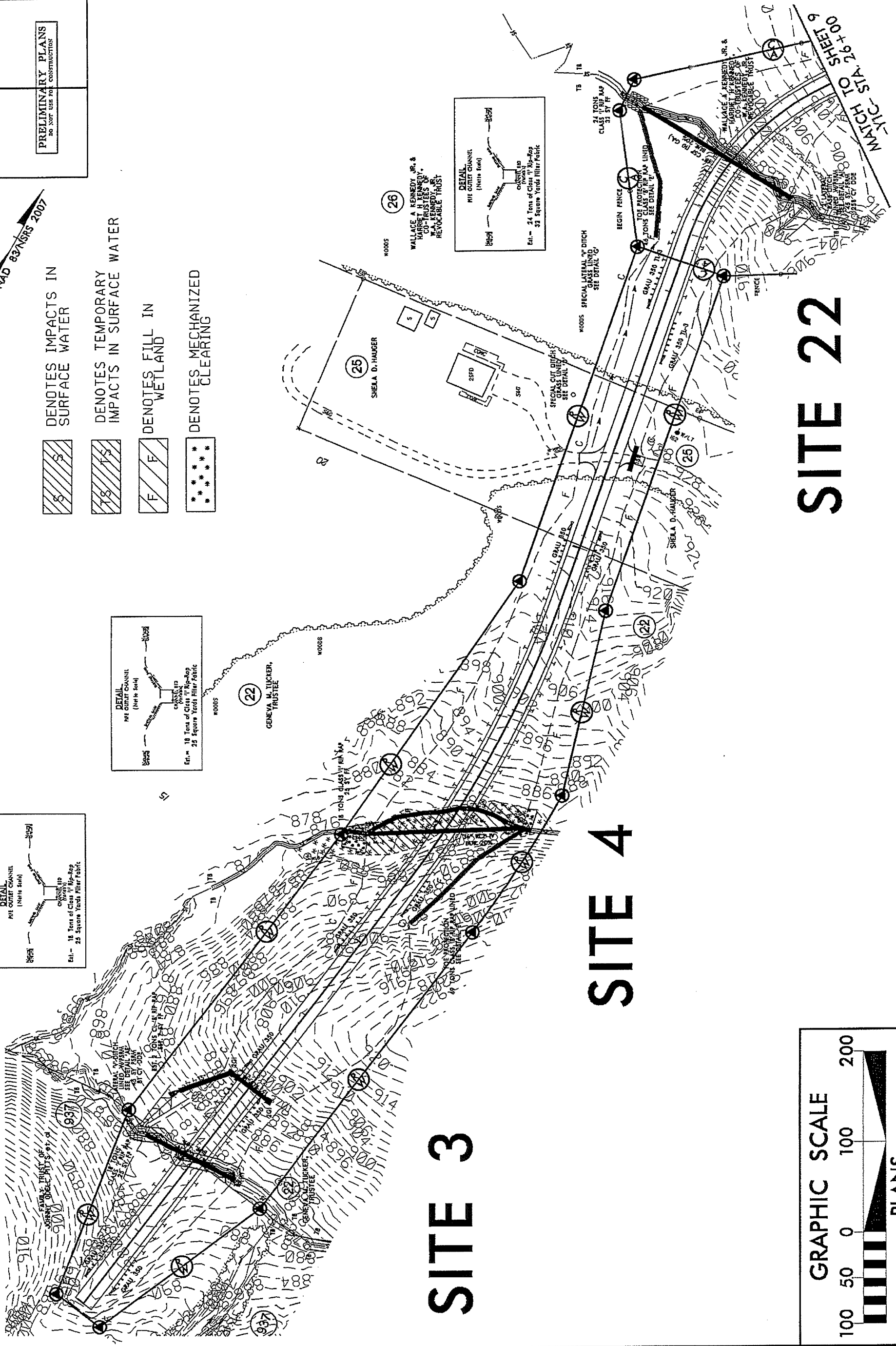
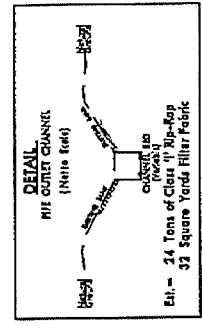
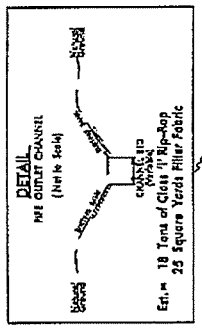
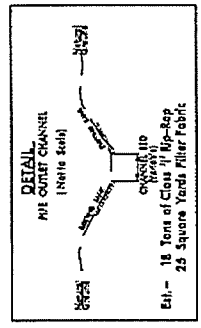

SITE 3

SITE 4

SITE 22

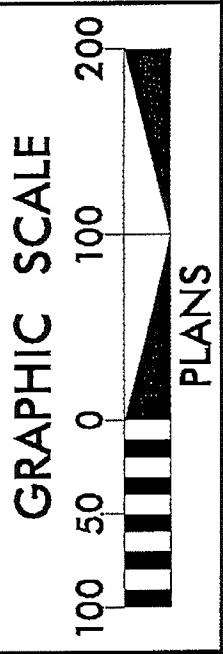



REVISIONS
DESIGN REVISION: THE HORIZONTAL DESIGN FOR -YIC- HAS BEEN REVISED, THE LEFT TURN LANE ON -YIC- HAS BEEN REMOVED AND THE CONCRETE ISLAND HAS BEEN REVISD TO RESTRICT LEFT TURNS OUT OF -YIC- ULT 1/28/2013
R/W REVISION: THE RIGHT OF WAY LABELS ON -YIC- LOCATED ON PARCEL 26 HAVE BEEN REVISED BUT THE RIGHT OF WAY AREA HAS NOT CHANGED. CEH 2/7/13
R/W REVISION: PROPERTY OWNER NAME AND DEED BOOK INFORMATION HAS BEEN CHANGED ON PARCELS 25 AND 26. CEH 2/27/13
8/17/99

PROJECT REFERENCE NO.	R-243A	SHEET NO.	37
ROADWAY DESIGN ENGINEER	HYDRAULICS ENGINEER		
PRELIMINARY PLANS DO NOT USE FOR CONSTRUCTION			

Permit Drawing 01
Sheet 74 of 81

NAD 83/NRS 2007

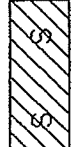
SITE 3 SITE 4

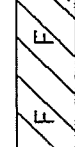
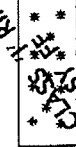
-  DENOTES IMPACTS IN SURFACE WATER
-  DENOTES TEMPORARY IMPACTS IN SURFACE WATER
-  DENOTES FILL IN RIP RAP WETLAND
-  DENOTES MECHANIZED CLEARING

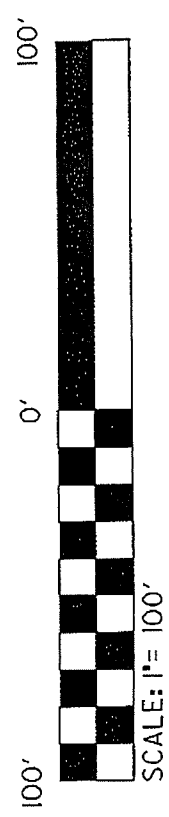
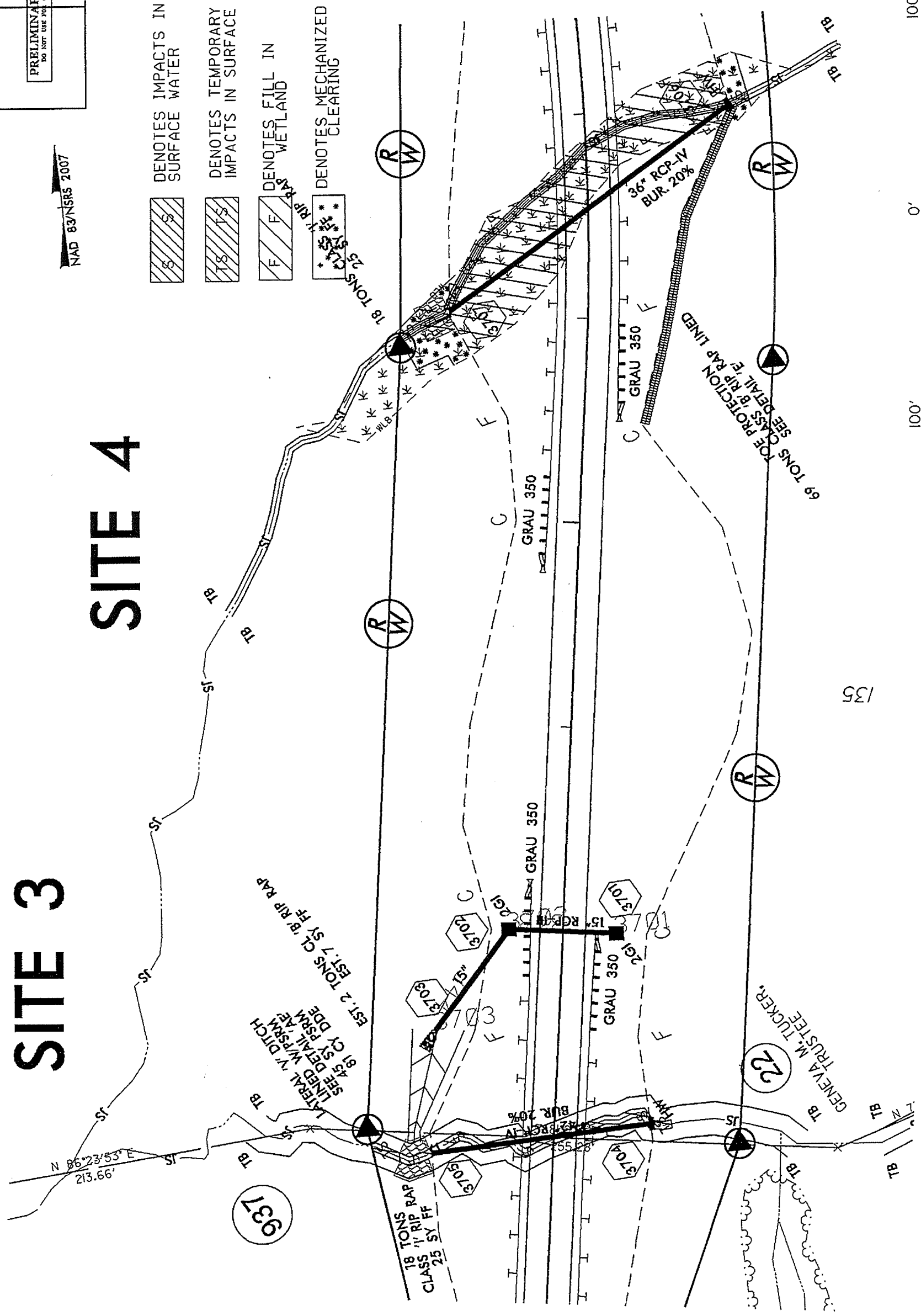

REVISIONS	
-----------	--

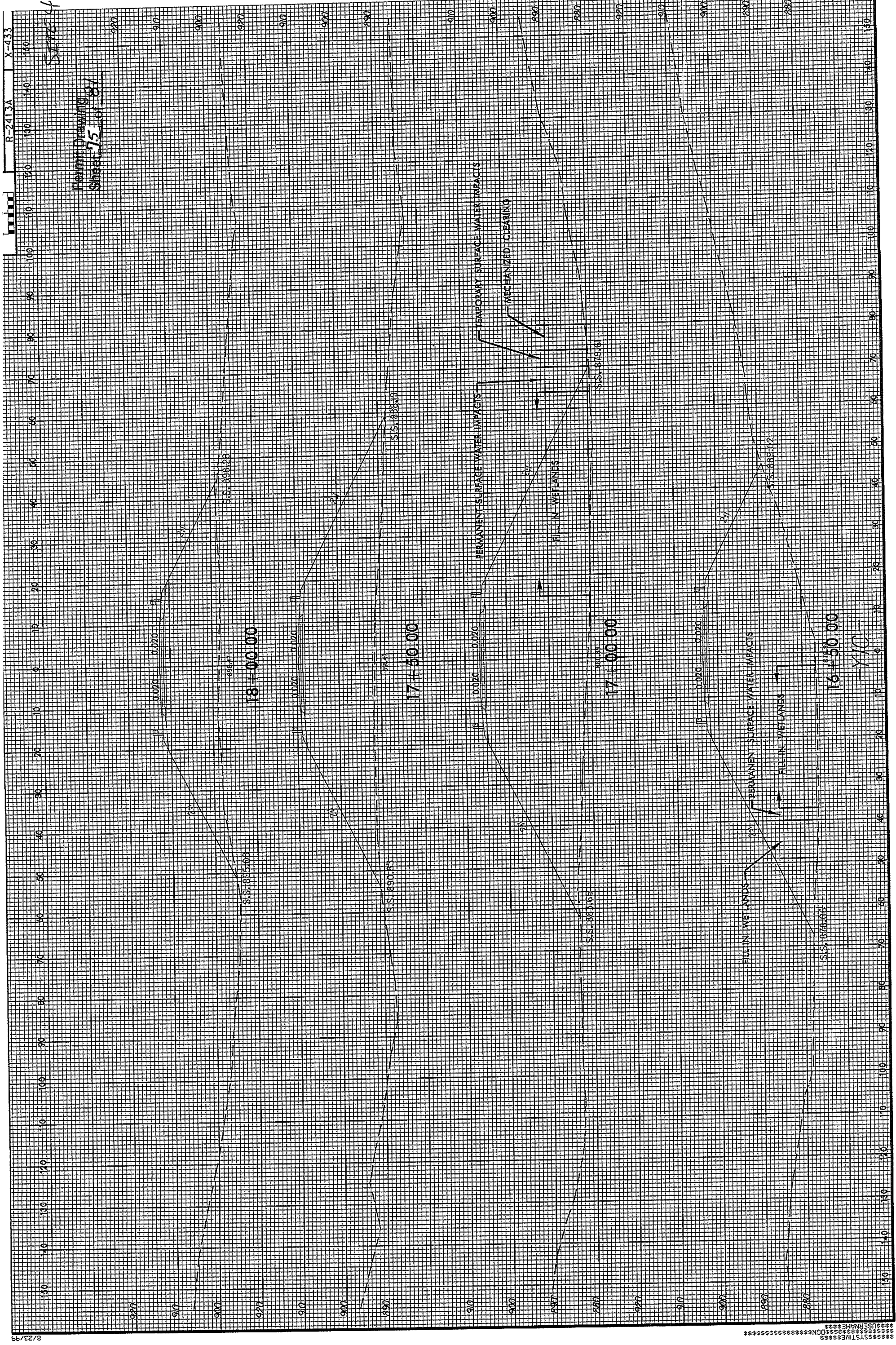



Permit Drawing
 Sheet 75 of 81

R-2413A X-433

NAD 83/NGRS 2007

R-2413A	37
ROADWAY DESIGN ENGINEER	HYDRAULICS ENGINEER
PRELIMINARY PLANS DO NOT USE FOR CONSTRUCTION	

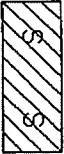
SITE 22

 DENOTES IMPACTS IN SURFACE WATER
 DENOTES TEMPORARY IMPACTS IN SURFACE WATER

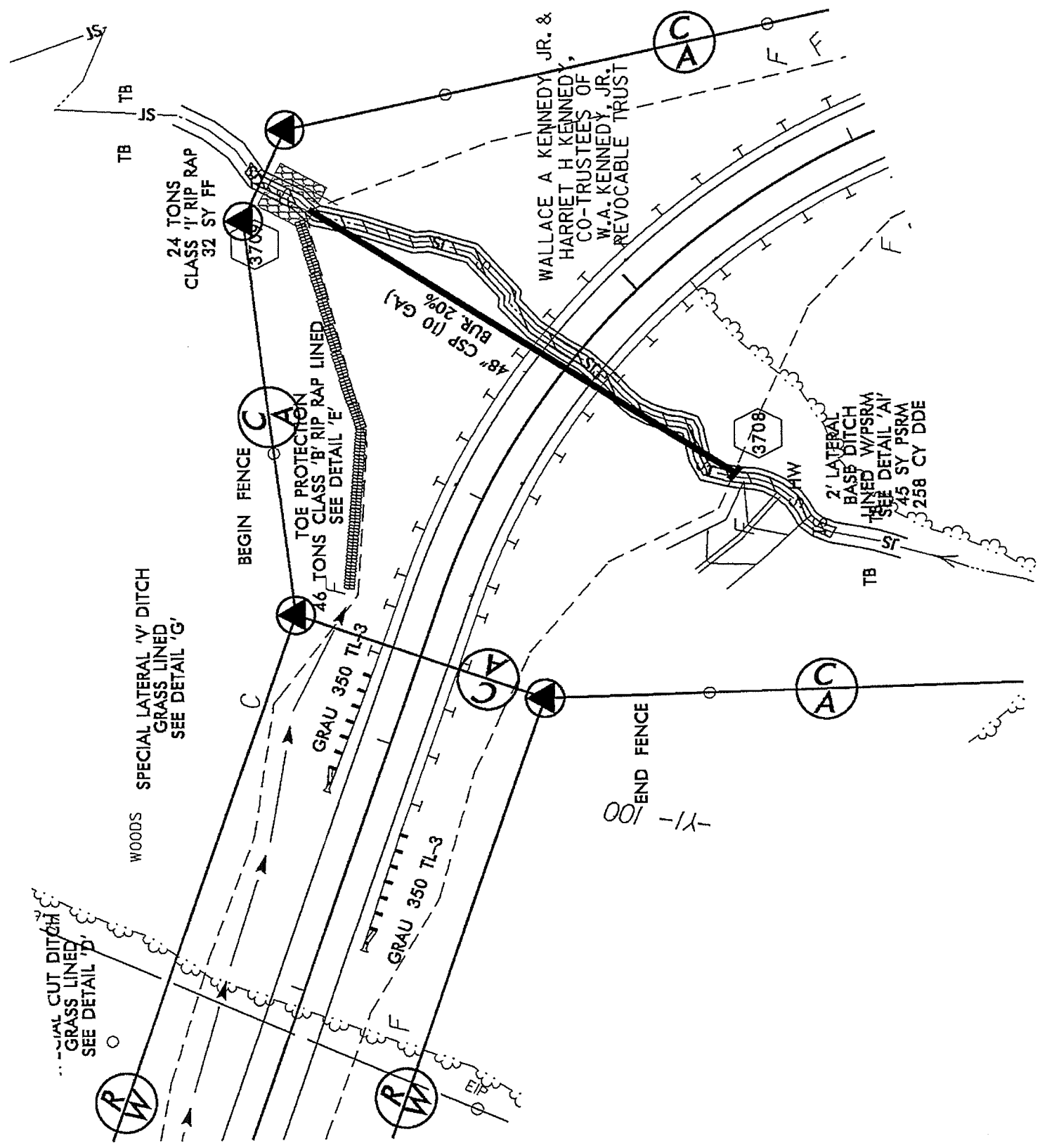
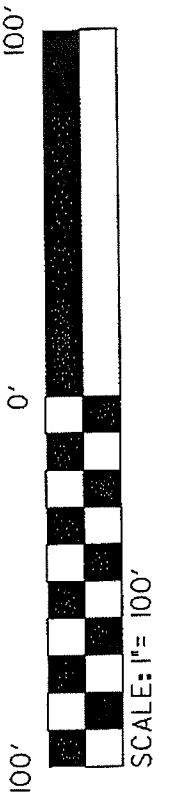

NO.	DATE	REVISIONS

8/17/95

WETLAND PERMIT IMPACT SUMMARY

Site No.	Station (From/To)	Structure Size / Type	WETLAND IMPACTS						SURFACE WATER IMPACTS					
			Permanent Fill In Wetlands (ac)	Temp. Fill In Wetlands (ac)	Excavation in Wetlands (ac)	Mechanized Clearing in Wetlands (ac)	Hand Clearing in Wetlands (ac)	Permanent SW impacts (ac)	Temp. SW impacts (ac)	Existing Channel Impacts Permanent (ft)	Existing Channel Impacts Temp. (ft)	Natural Stream Design (ft)		
1	26+50 to 32+50 -RP1B-	42" RCP Bank Stabilization	0.01						0.13	<0.01	699	22		
2	117+00 -L-	66" CSP												
2a.		Road Fill							<0.01	<0.01	60	18		
2b.		Road Fill							<0.01	<0.01	44	7		
2c.		Road Fill							0.05	<0.01	366	22		
		Bank Stabilization									20			
3	133+50 -L- & 12+00 -Y1C-	36" CSP & 42" RCP Bank Stabilization							0.02	<0.01	212	36		
											32			
4	138+00 -L- & 16+00 to 17+00 -Y1C-	2 @ 36" CSP Bank Stabilization	0.24			0.02			0.02	<0.01	523	42		
											30			
5	161+00 to 162+00 -L-	66" SPSP Bank Stabilization							0.03	<0.01	408	33		
											20			
6	193+50 to 197+00 -L-	60" RCP & 54" CSP Bank Stabilization	<0.01						0.04	<0.01	409	21		
											23			
SUBTOTALS:			0.26			0.02			0.29	0.08	2,866	201		

NC DEPARTMENT OF TRANSPORTATION
DIVISION OF HIGHWAYS
GUILFORD COUNTY
WBS - 34429.1.1 (R-2413A)

WETLAND PERMIT IMPACT SUMMARY

Site No.	Station (From/To)	Structure Size / Type	WETLAND IMPACTS						SURFACE WATER IMPACTS									
			Permanent Fill In Wetlands (ac)	Temp. Fill In Wetlands (ac)	Excavation in Wetlands (ac)	Mechanized Clearing in Wetlands (ac)	Hand Clearing in Wetlands (ac)	Permanent SW impacts (ac)	Temp. SW impacts (ac)	Existing Channel Impacts Permanent (ft)	Existing Channel Impacts Temp. (ft)	Natural Stream Design (ft)						
7	206+50 to 208+50 -L-	60" CSP & 54" CSP																
7a.		Bank Stabilization									0.03	<0.01	379	21				
7b.											<0.01	<0.01	26	10				
7c.											<0.01		31					
8	228+00 to 233+50 -L-	66" CSP																
8a.		Bank Stabilization									0.06	<0.01	654	50				
8b.											<0.01		21					
8c.											<0.01		50					
													34					
9	232+50 to 235+50 -L-	42" CSP									0.60 (pond)							
10	247+50 -L-	72" CSP																
10a.		Bank Stabilization	0.01		<0.01						0.05	<0.01	426	41				
10b.											<0.01		20					
10c.			<0.01			0.01					0.01		49					
													116					
11	249+50 to 251+50 -L-	48" CSP	0.12								<0.01	<0.01	47	17				
SUBTOTALS:			0.14		<0.01	0.01				0.81	0.05	1,898	139					

NC DEPARTMENT OF TRANSPORTATION
 DIVISION OF HIGHWAYS
 GUILFORD COUNTY
 WBS - 34429.1.1 (R-2413A)

WETLAND PERMIT IMPACT SUMMARY																	
Site No.	Station (From/To)	Structure Size / Type	WETLAND IMPACTS					SURFACE WATER IMPACTS									
			Permanent Fill In Wetlands (ac)	Temp. Fill In Wetlands (ac)	Excavation in Wetlands (ac)	Mechanized Clearing in Wetlands (ac)	Hand Clearing in Wetlands (ac)	Permanent SW impacts (ac)	Temp. SW impacts (ac)	Existing Channel Impacts Permanent (ft)	Existing Channel Impacts Temp. (ft)	Natural Stream Design (ft)					
17	334+00 to 336+50 -L-	36" CSP	0.35		0.03												
18	338+00 to 340+50 -L-	Bridge		0.04				0.13							128		
19	348+00 to 353+00 -L-	60" RCP								0.03						507	34
20	17+50 to 19+00 -Y4-	36" CSP	0.11							0.02						240	
21	29+00 to 36+00 -Y5-	1 @ 12' X 12' RCBC															
21a.			2.11		0.13					0.06						288	262
21b.		Road Fill								0.01						149	
22	24+50 -Y1C-	48" CSP								0.02						256	22
		Bank Stabilization														20	
SUBTOTALS:			2.57	0.04	<0.01	0.13	0.13	0.13	0.14	0.13	1.460	0.13	446	250			
TOTALS:			3.13	0.04	<0.01	0.19	0.13	0.13	1.45	0.29	8,917	0.29	866	2,732			

* See Plan for On-Site Mitigation

NC DEPARTMENT OF TRANSPORTATION
 DIVISION OF HIGHWAYS
 GUILFORD COUNTY
 WBS - 34429.1.1 (R-2413A)
 SHEET 81 OF 81 5/2/2013

SILL DETAIL

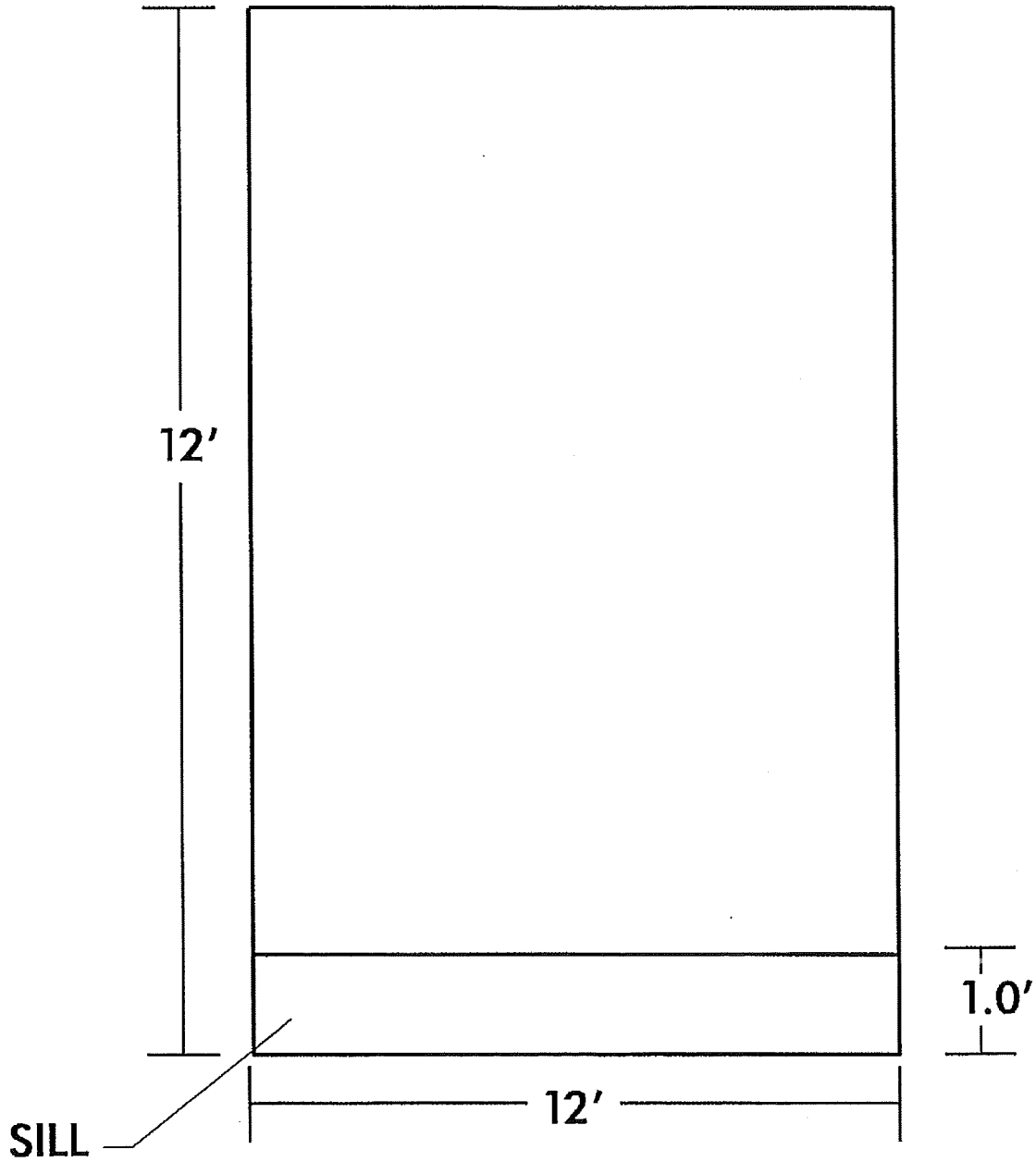

(PLACE SILL AT INLET AND OUTLET)

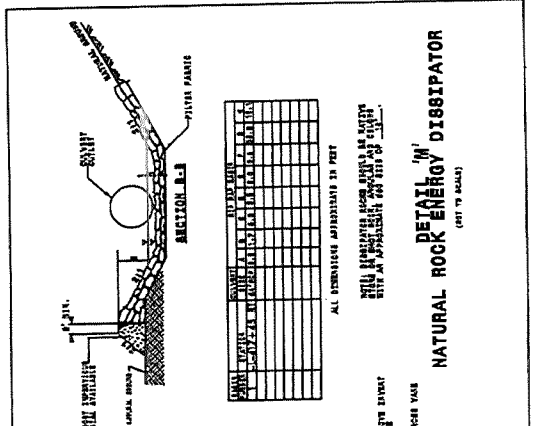
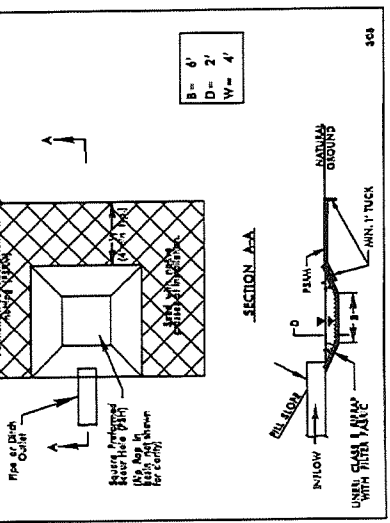
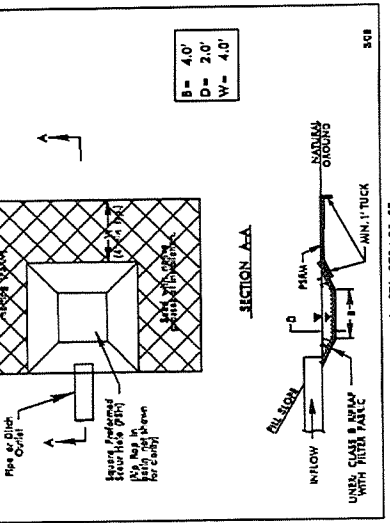
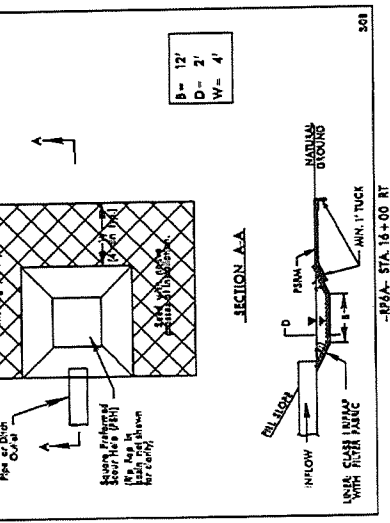
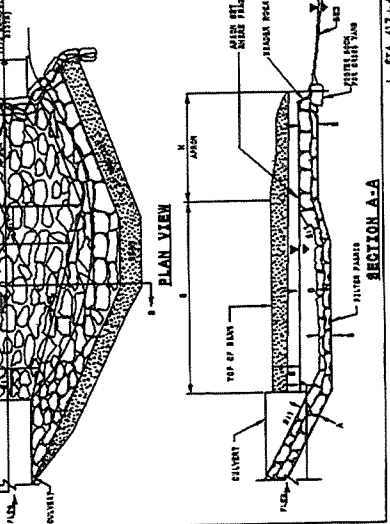
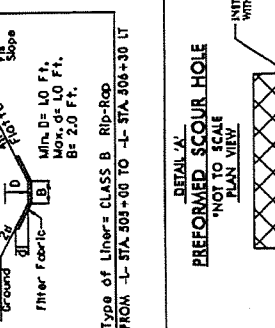
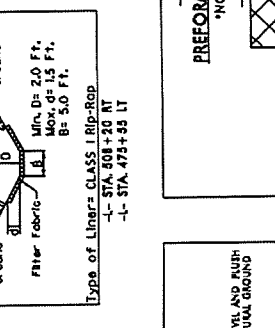
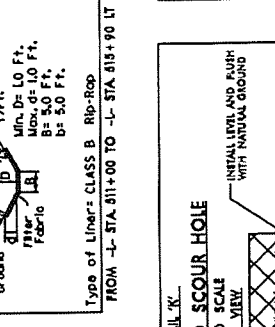
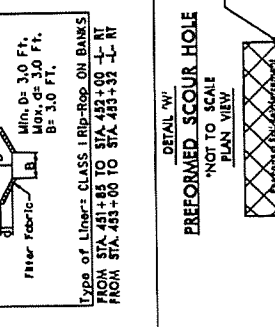
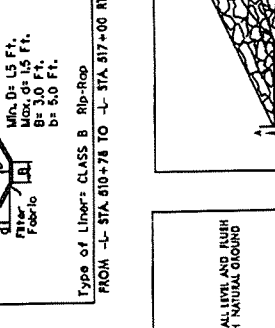
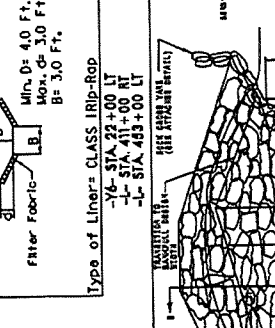
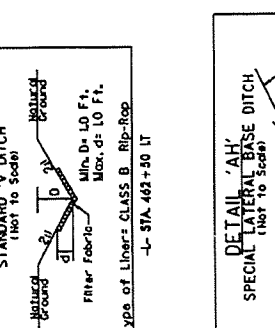
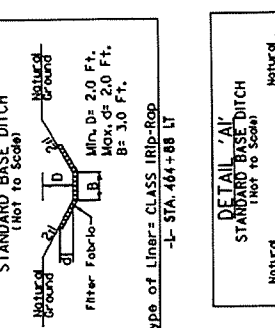
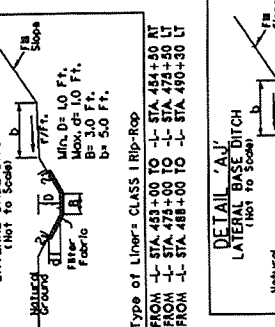
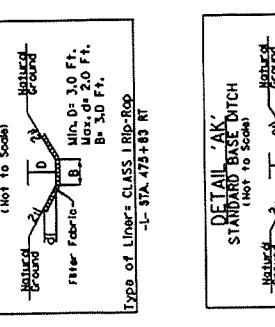
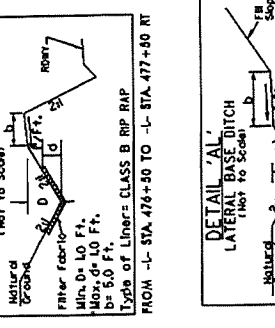
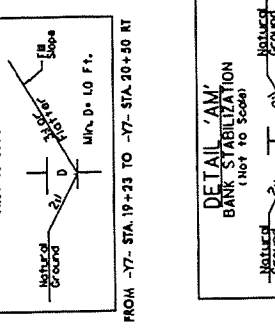
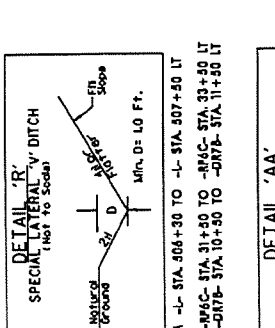
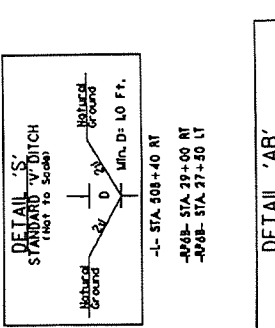
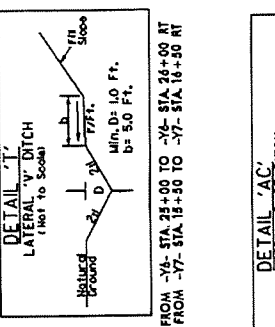
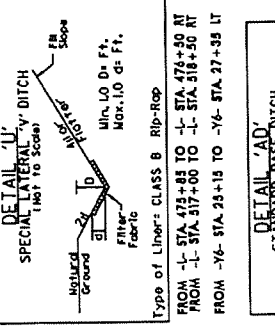
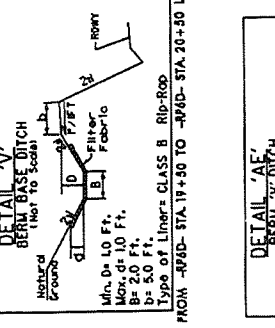
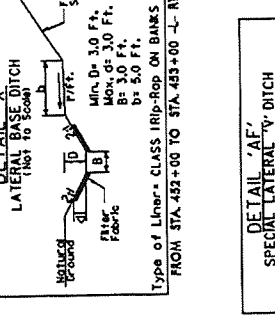
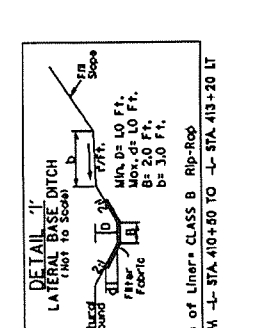
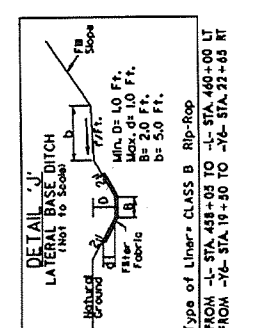
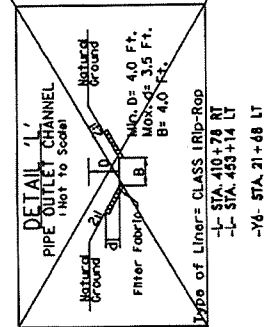
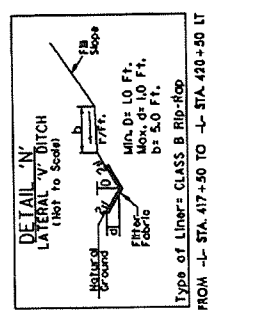
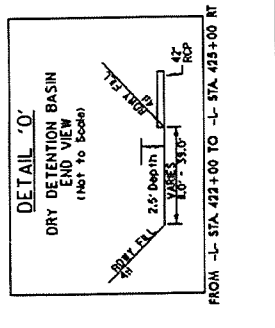
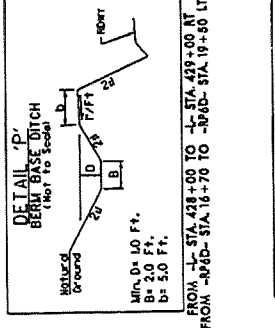
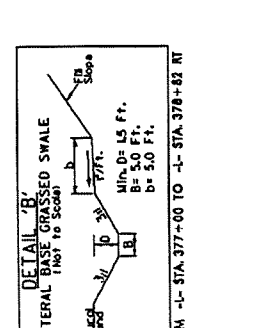
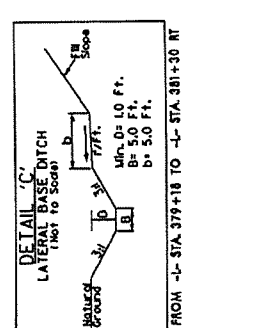
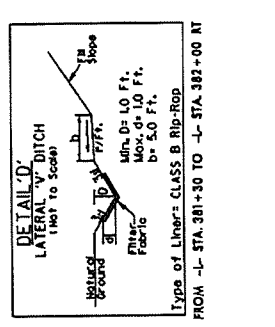
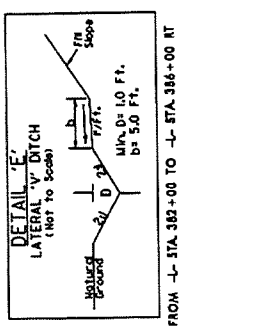
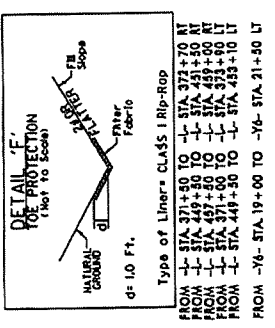
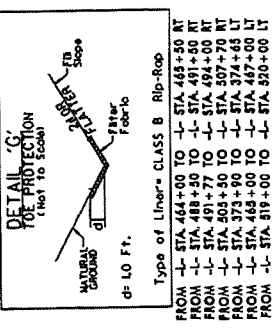

PROJECT REFERENCE NO. R-2413B
 SHEET NO. 4
 HYDRAULICS ENGINEER
 ROADWAY DESIGN ENGINEER
 PRELIMINARY PLANS
 DO NOT USE FOR CONSTRUCTION

Permit Drawing
 Sheet 3 of 3

NAD 83/NSRS 2007

BEGIN TIP PROJECT R-2413B -L- Sta. 370+50.00
 END TIP PROJECT R-2413A -L- Sta. 370+50.00
 TIE GUARDRAIL & MEDIAN GUIDERAIL TO TIP PROJECT R-2413A

SITE 1

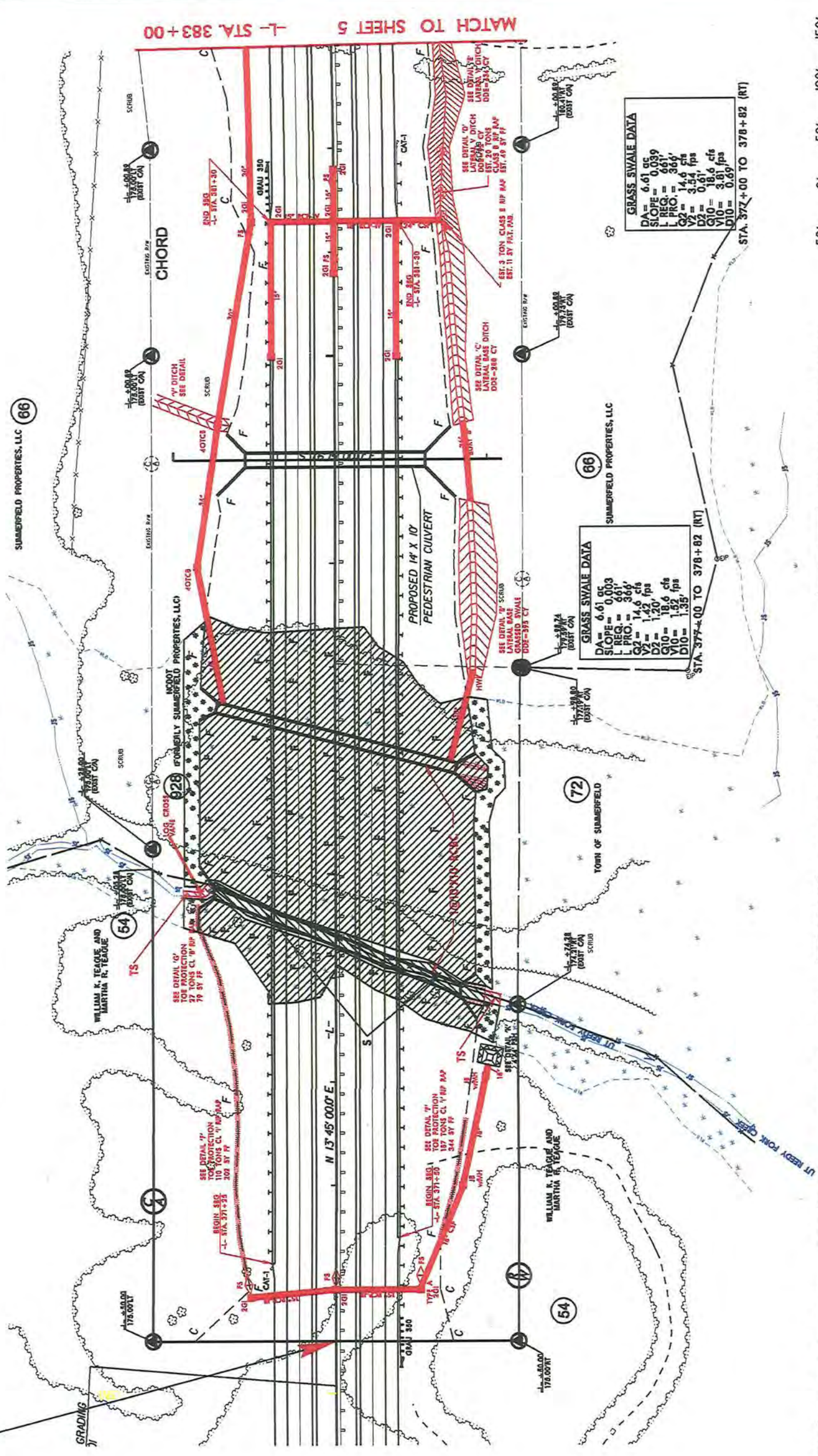

GRASS SWALE DATA

DA =	6.61	gc
SLOPE =	0.039	
L. PRO. =	366'	
Q2 =	14.6	cfs
D2 =	3.54	fps
Q10 =	18.6	cfs
V10 =	3.81	fps
D10 =	0.69'	

GRASS SWALE DATA

DA =	6.61	gc
SLOPE =	0.003	
L. PRO. =	641'	
Q2 =	1.42	cfs
D2 =	1.20	fps
Q10 =	18.6	cfs
V10 =	1.52	fps
D10 =	1.35'	

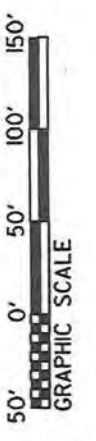

***** DENOTES MECHANIZED CLEARING

***** DENOTES TEMPORARY IMPACTS IN SURFACE WATER

TS TS DENOTES IMPACTS IN SURFACE WATER

S S DENOTES IMPACTS IN SURFACE WATER

F F DENOTES FILL IN WETLAND

F F DENOTES FILL IN WETLAND

REVISIONS

PROJECT REFERENCE NO. R-2413B
 SHEET NO. 4
 HYDRAULICS ENGINEER
 ROADWAY DESIGN ENGINEER
 PRELIMINARY PLANS
 DO NOT USE FOR CONSTRUCTION
 Permit Drawing
 Sheet 4 of 12

NAD 83/NSRS 2007

BEGIN TIP PROJECT R-2413B -L- Sta. 370+50.00
 END TIP PROJECT R-2413A -L- Sta. 370+50.00
 TIE GUARDRAIL & MEDIAN GUIDERAIL TO TIP PROJECT R-2413A

SITE 1

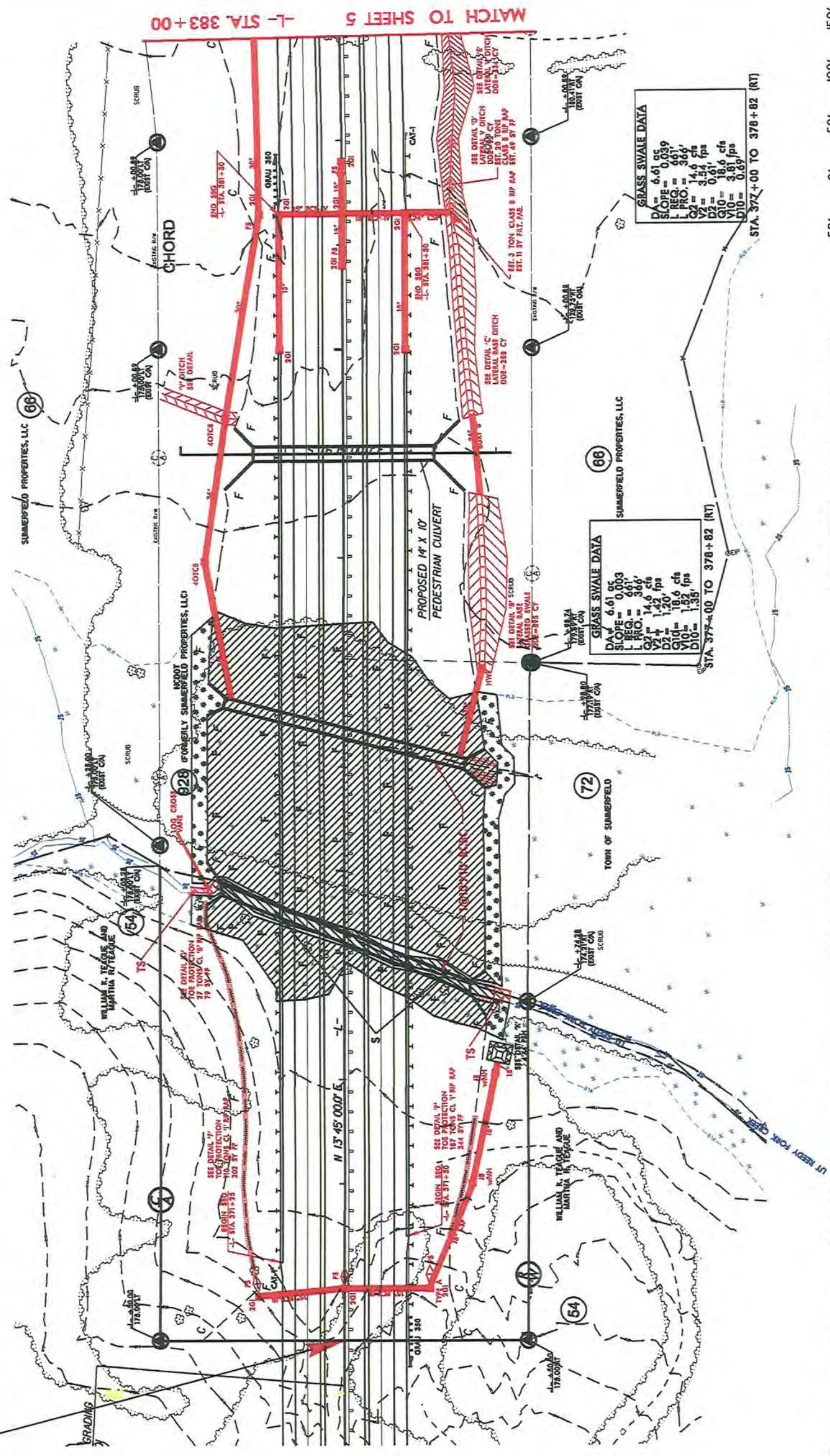

***** DENOTES MECHANIZED CLEARING

TS TS DENOTES TEMPORARY IMPACTS IN SURFACE WATER

S S DENOTES IMPACTS IN SURFACE WATER

F F DENOTES FILL IN WETLAND

PROJECT REFERENCE NO. R-2413B
 SHEET NO. 7
 BY SHEET NO. HYDRAULICS ENGINEER
 ROADWAY DESIGN ENGINEER
 PRELIMINARY PLANS
 DO NOT USE FOR CONSTRUCTION

Permit Drawing
 Sheet 7 of 31
 NAD 83/NRS 2007

SITE 2

SITE 3

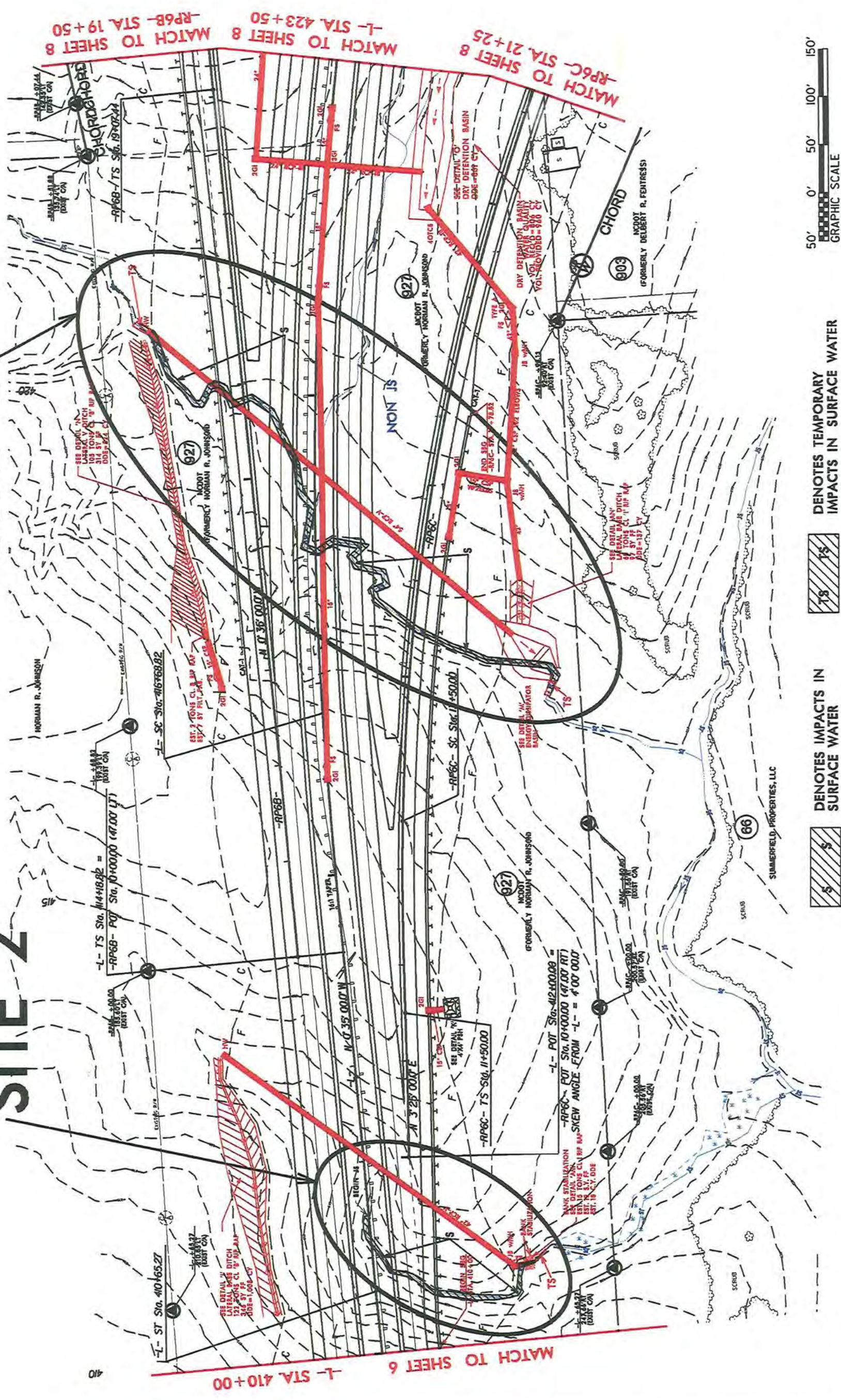

TS TS TS
 DENOTES TEMPORARY IMPACTS IN SURFACE WATER

S S S
 DENOTES IMPACTS IN SURFACE WATER

8/17/99

NO.	DATE	DESCRIPTION

REVISIONS

PROJECT REFERENCE NO.	R-243B	SHEET NO.	9
BY SHEET NO.		HYDRAULICS ENGINEER	
ROADWAY DESIGN ENGINEER			

PRELIMINARY PLANS
DO NOT USE FOR CONSTRUCTION

Permit Drawing 31
Sheet 10 of 31
MVD 8/17/99

SITE 5

SITE 5A

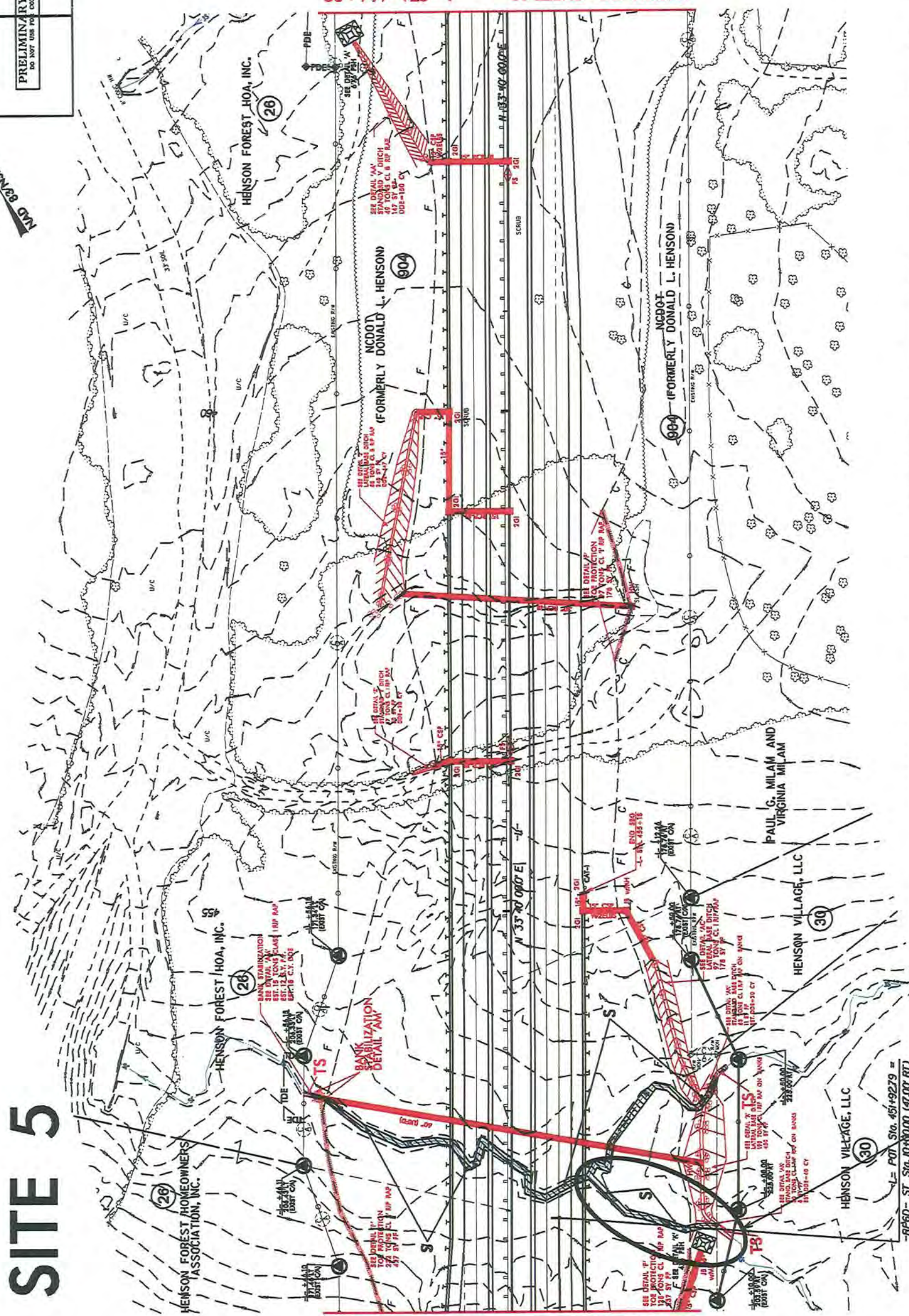

MATCH TO SHEET 10 -L- STA. 464+00

MATCH TO SHEET 8 -L- STA. 451+00



DENOTES TEMPORARY IMPACTS IN SURFACE WATER



DENOTES IMPACTS IN SURFACE WATER



REVISIONS

PROJECT REFERENCE NO. R-2433B
 SHEET NO. 10
 HW SHEET NO. ROADWAY DESIGN ENGINEER
 HYDRAULICS ENGINEER
PRELIMINARY PLANS
 DO NOT USE FOR CONSTRUCTION

Permit Drawing
 Sheet 11 of 31
 MD 2433B 2007

SITE 6

SITE 7

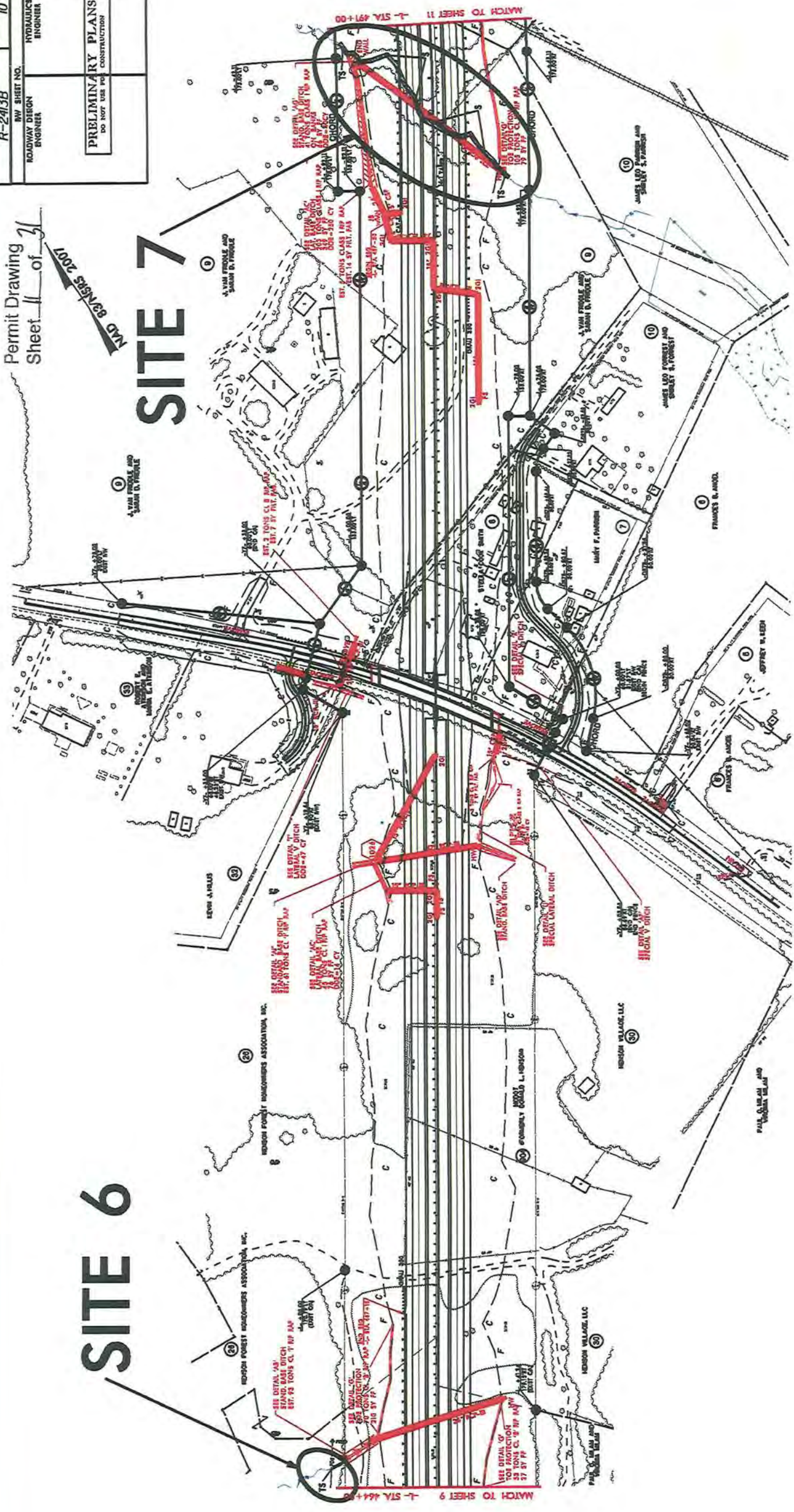

DENOTES IMPACTS IN SURFACE WATER
 DENOTES TEMPORARY IMPACTS IN SURFACE WATER

PROJECT REFERENCE NO. R-2413B
 HW SHEET NO. 10
 ROADWAY DESIGN ENGINEER
 HYDRAULICS ENGINEER

PRELIMINARY PLANS
 DO NOT USE FOR CONSTRUCTION

Permit Drawing
 Sheet 10 of 31

NOV 2007
 2007

SITE 6

SITE 7

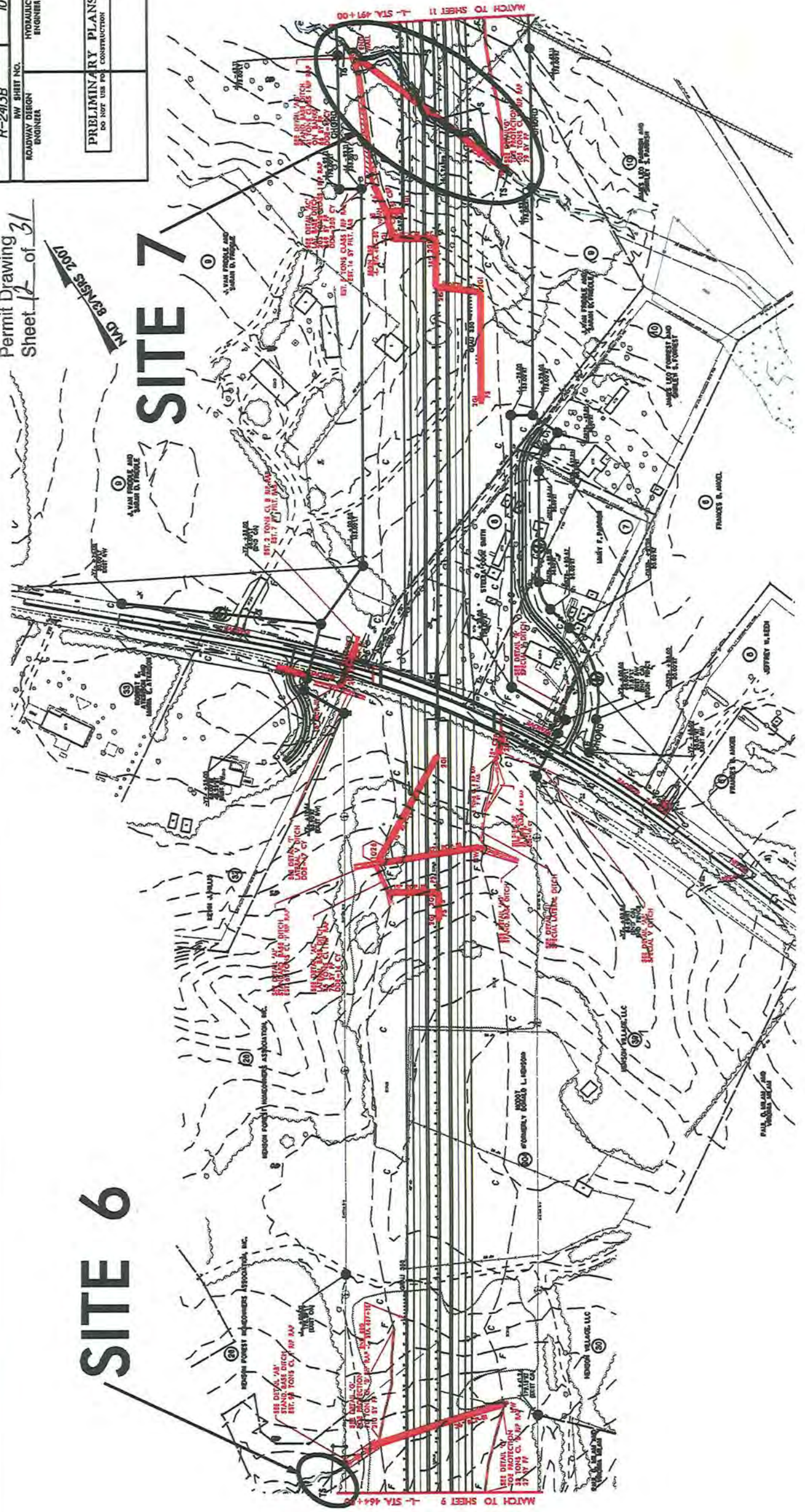

DIAGONAL HATCHING
 INDICATES IMPACTS IN SURFACE WATER

DIAGONAL HATCHING
 INDICATES IMPACTS IN SURFACE WATER

PROJECT REFERENCE NO. **R-2413B**
 ROADWAY DESIGN ENGINEER

SHEET NO. **12**
 HYDRAULICS ENGINEER

PRELIMINARY PLANS
 DO NOT USE FOR CONSTRUCTION

Permit Drawing **31**
 Sheet **13** of **31**

MAV 8/3/2017

SITE 8

STREAM RELOCATION
 SEE MITIGATION PLAN
 SHEET OSM 11

SITE 8g

SITE 8a

SITE 8c

SITE 8f

SITE 8b

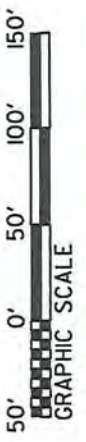
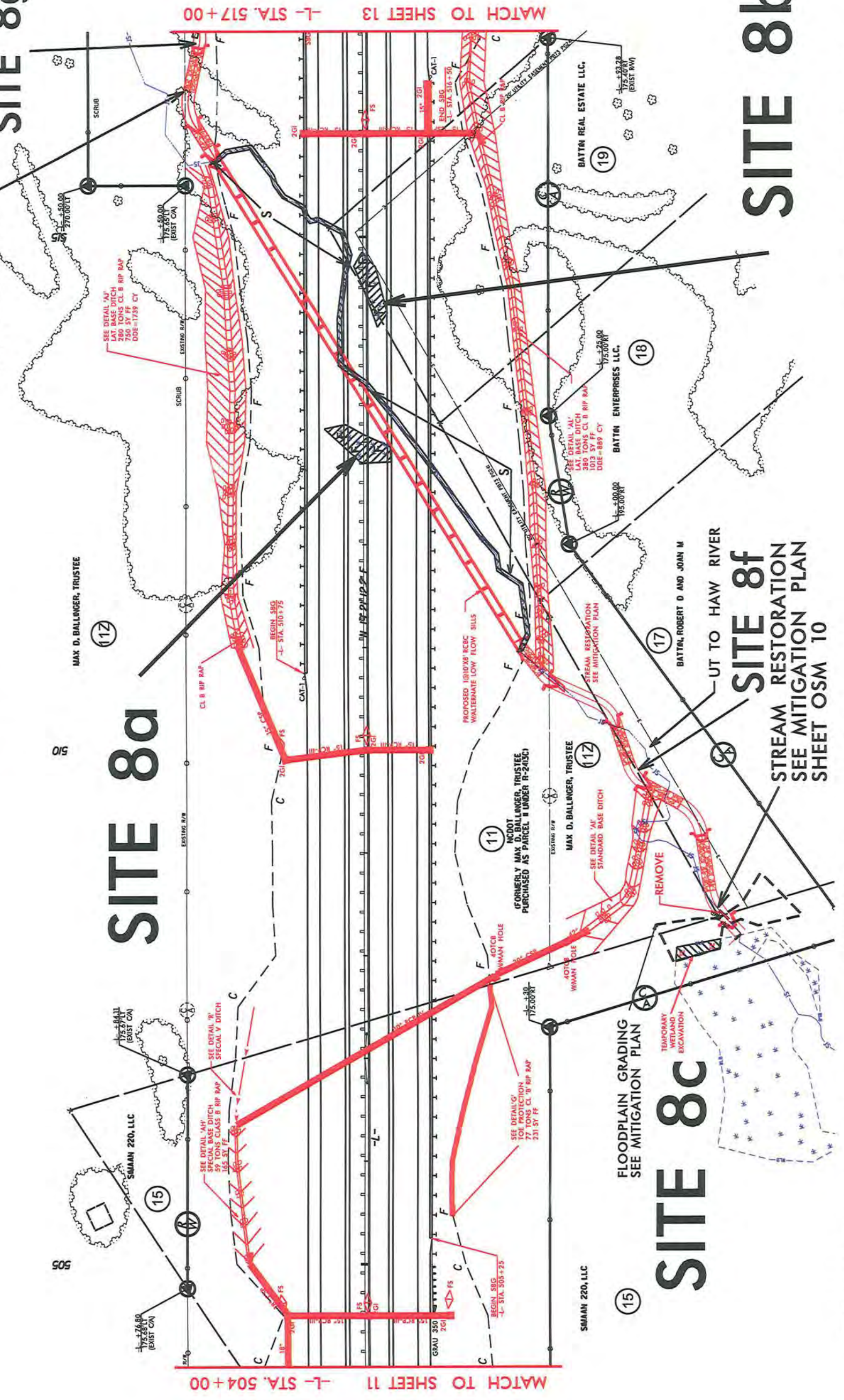

DENOTES IMPACTS IN SURFACE WATER

DENOTES TEMPORARY EXCAVATION IN WETLAND

MATCH TO SHEET 11 -L- STA. 504+00

MATCH TO SHEET 13 -L- STA. 517+00

PROJECT REFERENCE NO. R-2413B
 SHEET NO. 12
 ROADWAY DESIGN ENGINEER
 HYDRAULICS ENGINEER
PRELIMINARY PLANS
 DO NOT USE FOR CONSTRUCTION

Permit Drawing
 Sheet 14 of 31
 NAD 83 VERTICERS 2007

SITE 8

STREAM RELOCATION
 SEE MITIGATION PLAN
 SHEET OSM 11

SITE 8g

SITE 8a

MATCH TO SHEET 13 -L- STA. 517+00

MATCH TO SHEET 11 -L- STA. 504+00

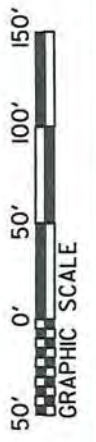
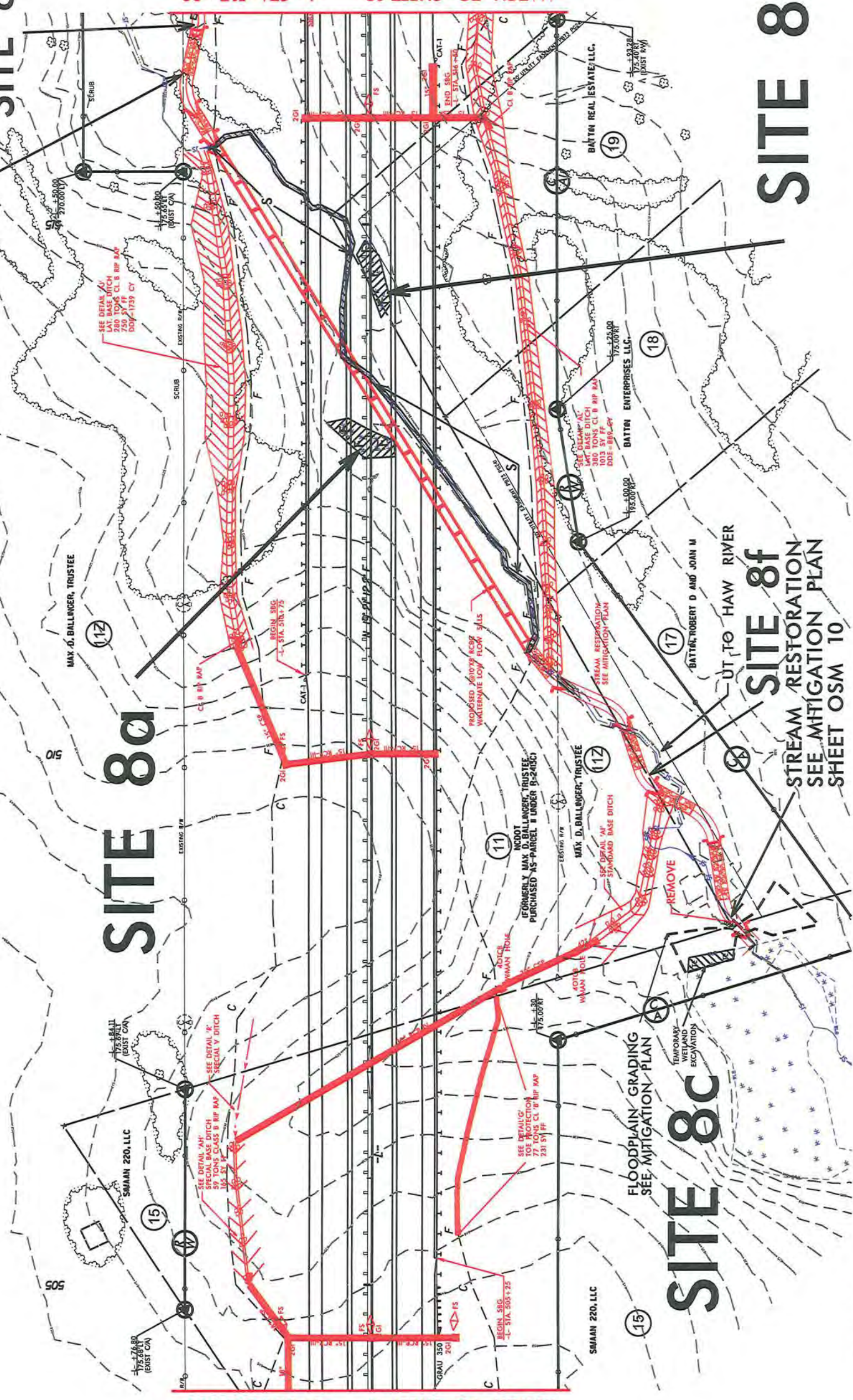

DENOTES IMPACTS IN
 SURFACE WATER

DENOTES TEMPORARY
 EXCAVATION IN WETLAND

REVISIONS

PROJECT REFERENCE NO. R-2413B	SHEET NO. 73
ROADWAY DESIGN ENGINEER	HYDRAULICS ENGINEER

Permit Drawing
Sheet 6 of 3
MAD 8/3/2007

PRELIMINARY PLANS
DO NOT USE FOR CONSTRUCTION

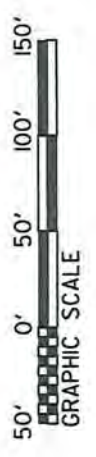
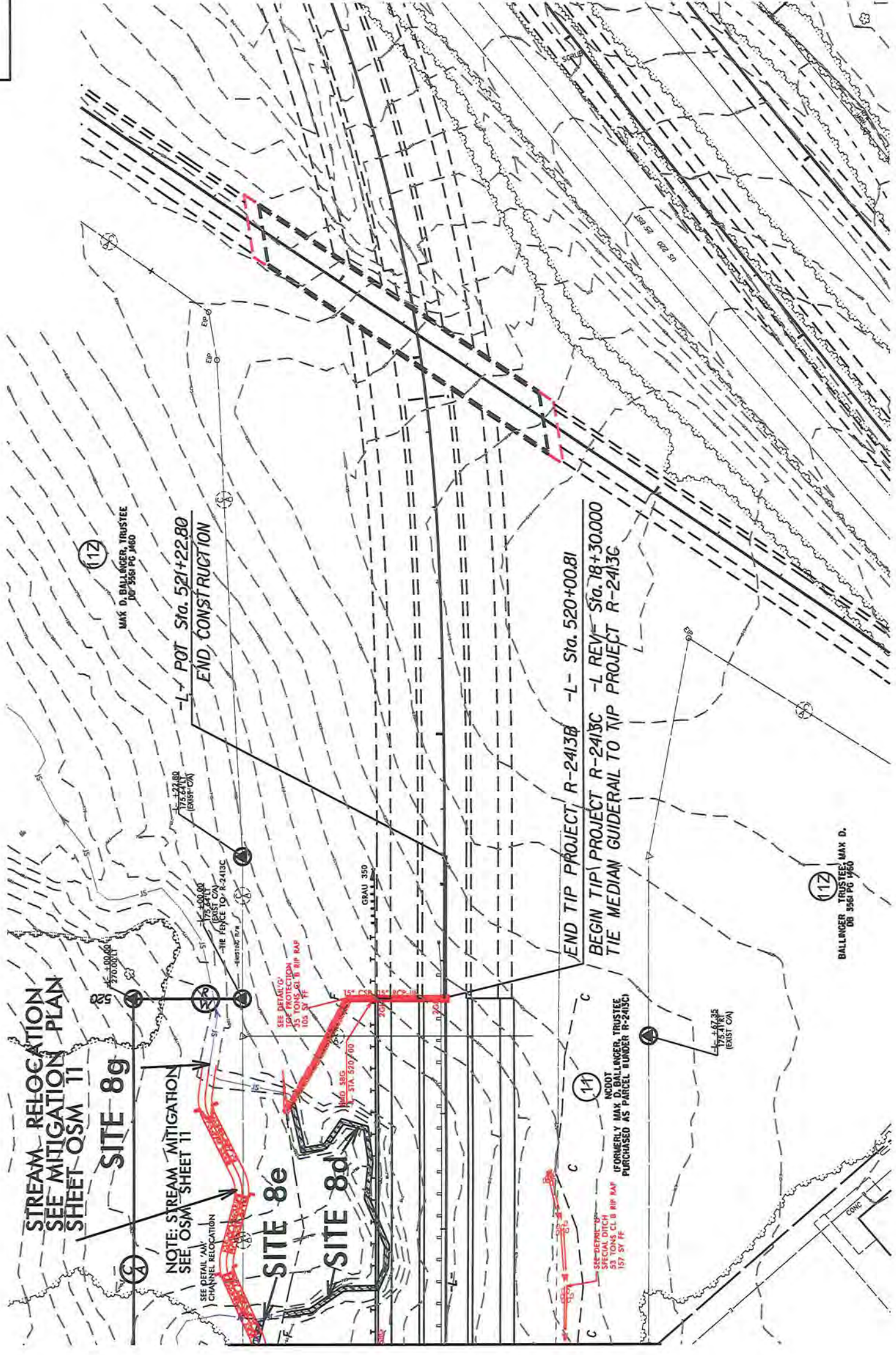

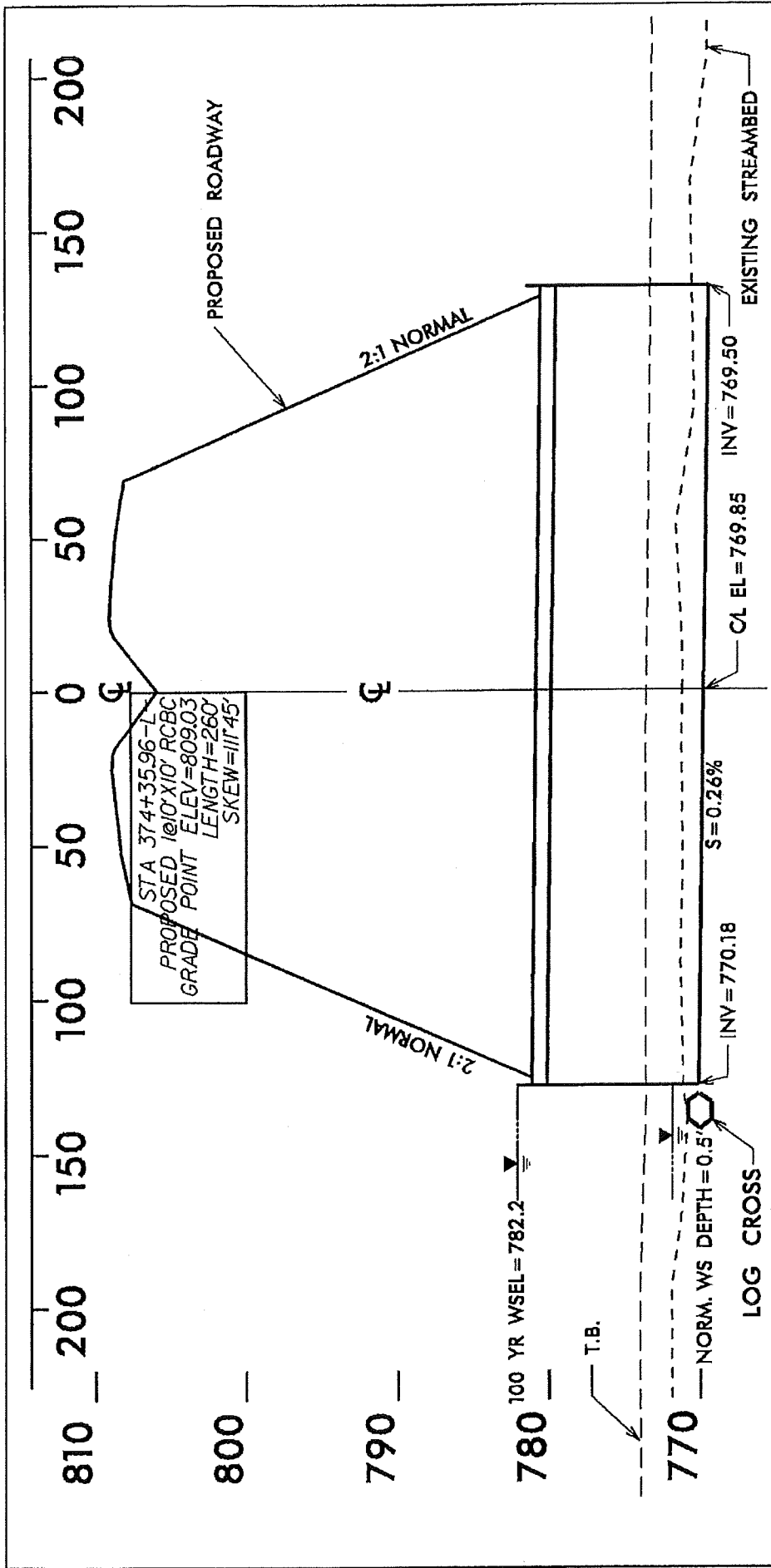

NCDOT
 DIVISION OF HIGHWAYS
 GUILFORD COUNTY
 PROJECT: 34429.11 (R2413B)
 NC 68 BETWEEN
 SR 2127 (BROOKBANK ROAD)
 AND NC 150

PROFILE
 SITE 1
 (MAIN CHANNEL)

SCALE
 1:50' HORIZONTAL
 1:10' VERTICAL

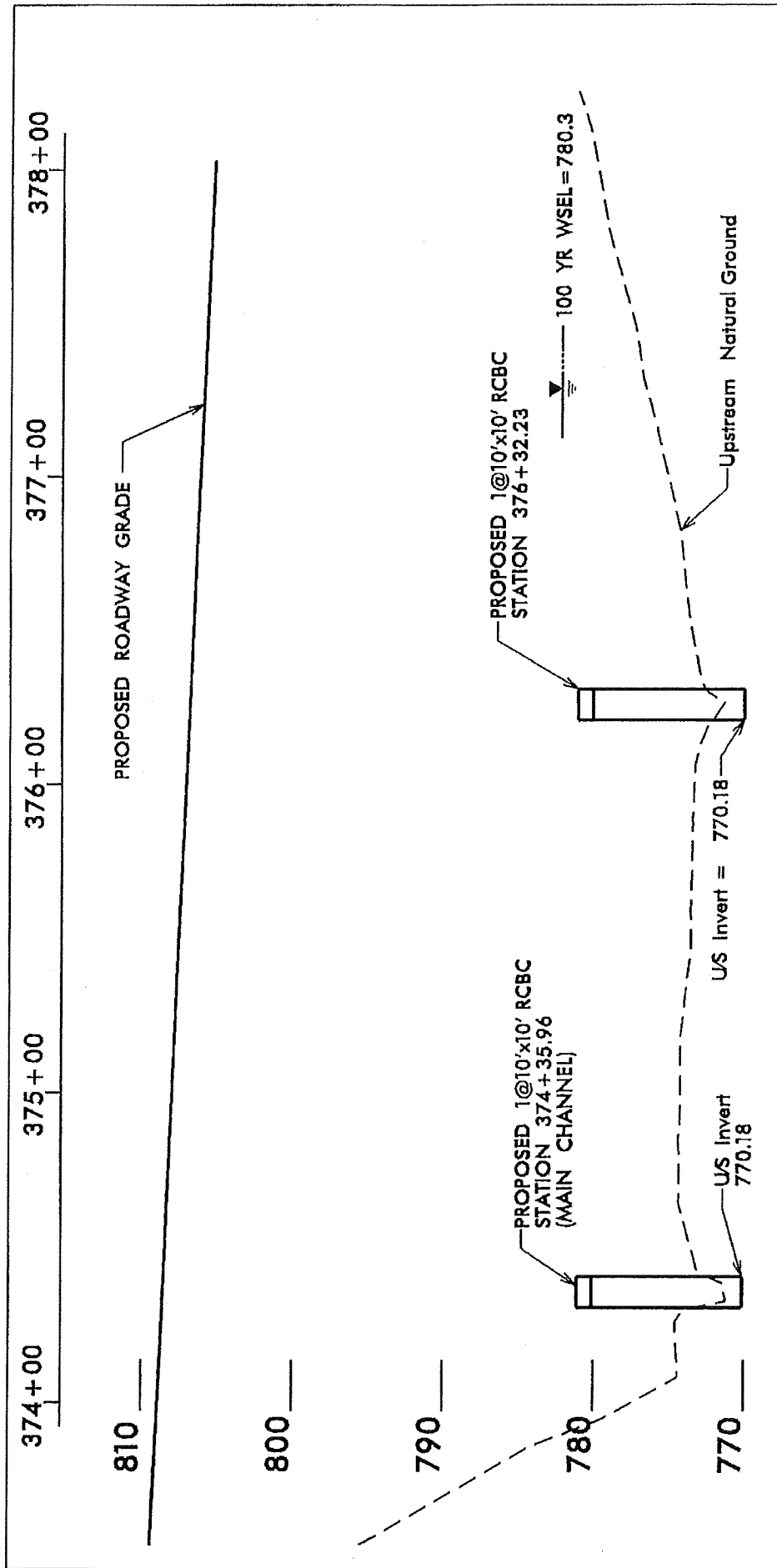

NCDOT
 DIVISION OF HIGHWAYS
 GUILFORD COUNTY
 PROJECT: 34429.1.1 (R2413B)
 NC 68 BETWEEN
 SR 2127 (BROOKBANK ROAD)
 AND NC 150

SECTION

SITE 1

SCALE
 1:50' HORIZONTAL
 1:10' VERTICAL

SHEET 19 OF 31 04/01/13

DETAIL OF RIP RAP ON BANKS AT D/S FACE OF 1@10'X10' RCBC

(N.T.S.)

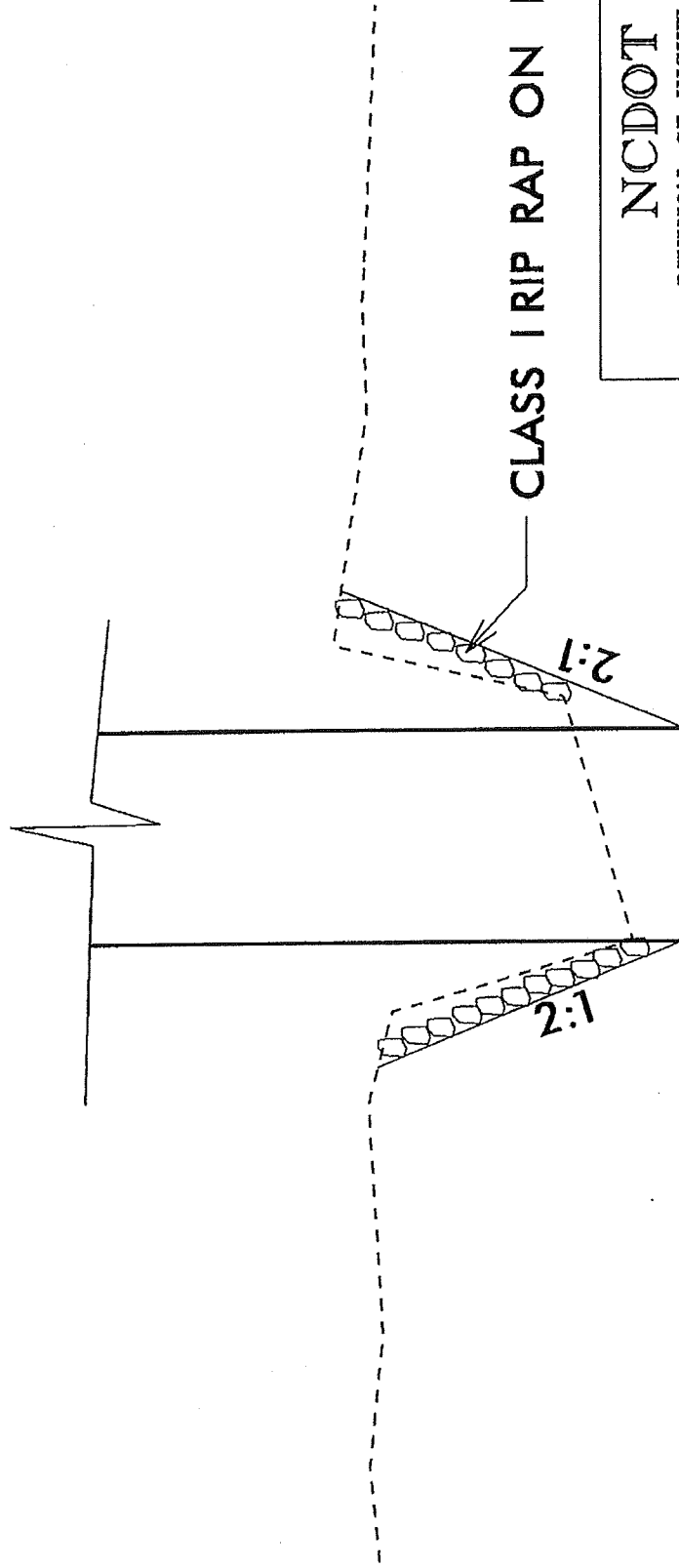

SITE 1

NC DOT
DIVISION OF HIGHWAYS
GUILFORD COUNTY
PROJECT: 34429.1.1 (R2413B)
NC 68 BETWEEN
SR 2127 (BROOKBANK ROAD)
AND NC 150

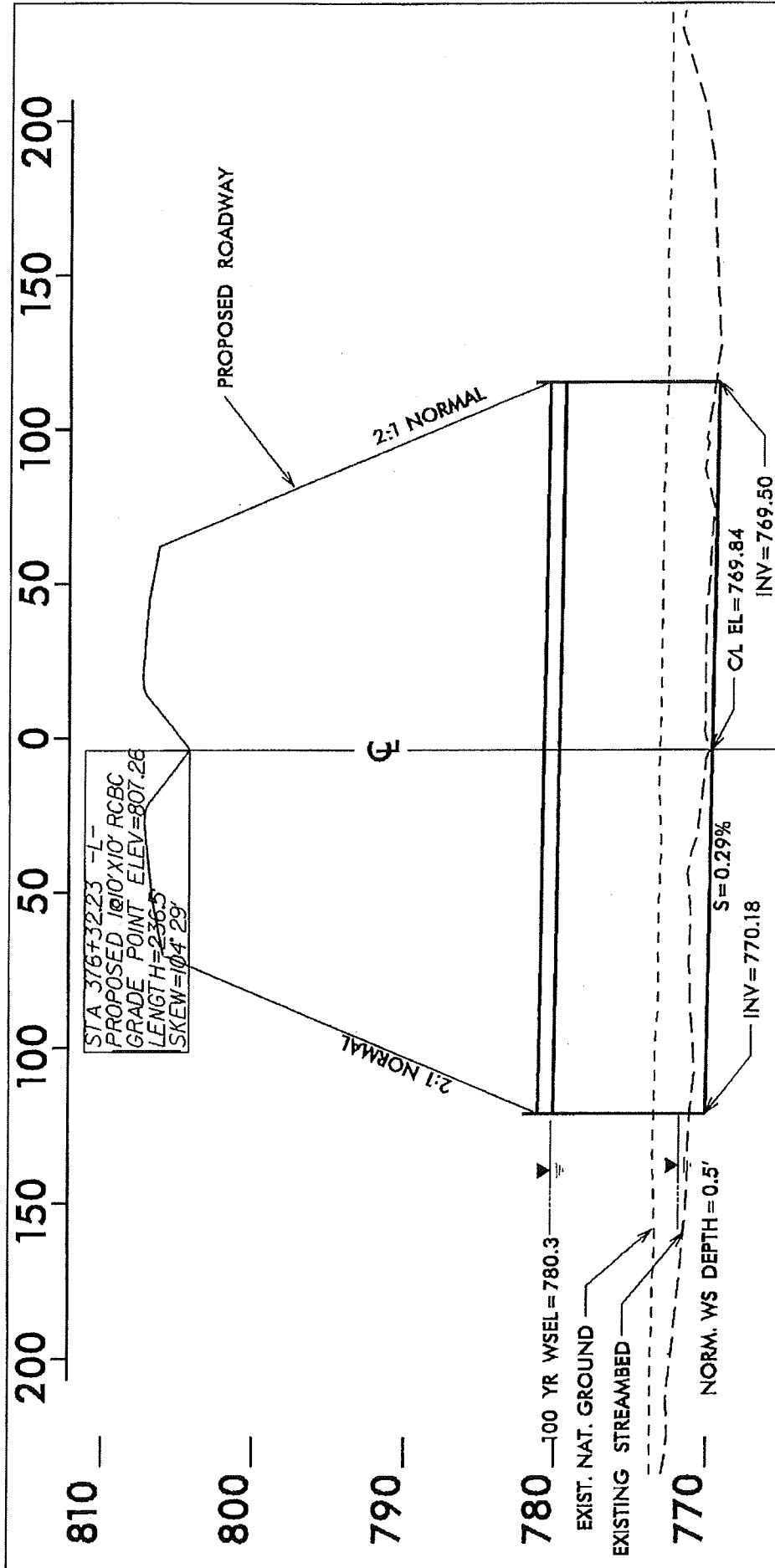

NCDOT
 DIVISION OF HIGHWAYS
 GUILFORD COUNTY
 PROJECT: 34429.1.1 (R2413B)
 NC 68 BETWEEN
 SR 2127 (BROOKBANK ROAD)
 AND NC 150

PROFILE
SITE 1

SCALE
 1:50' HORIZONTAL
 1:10' VERTICAL

DETAIL OF RIP RAP ON BANKS AT D/S FACE OF 1@10'X10' RCBC

(N.T.S.)

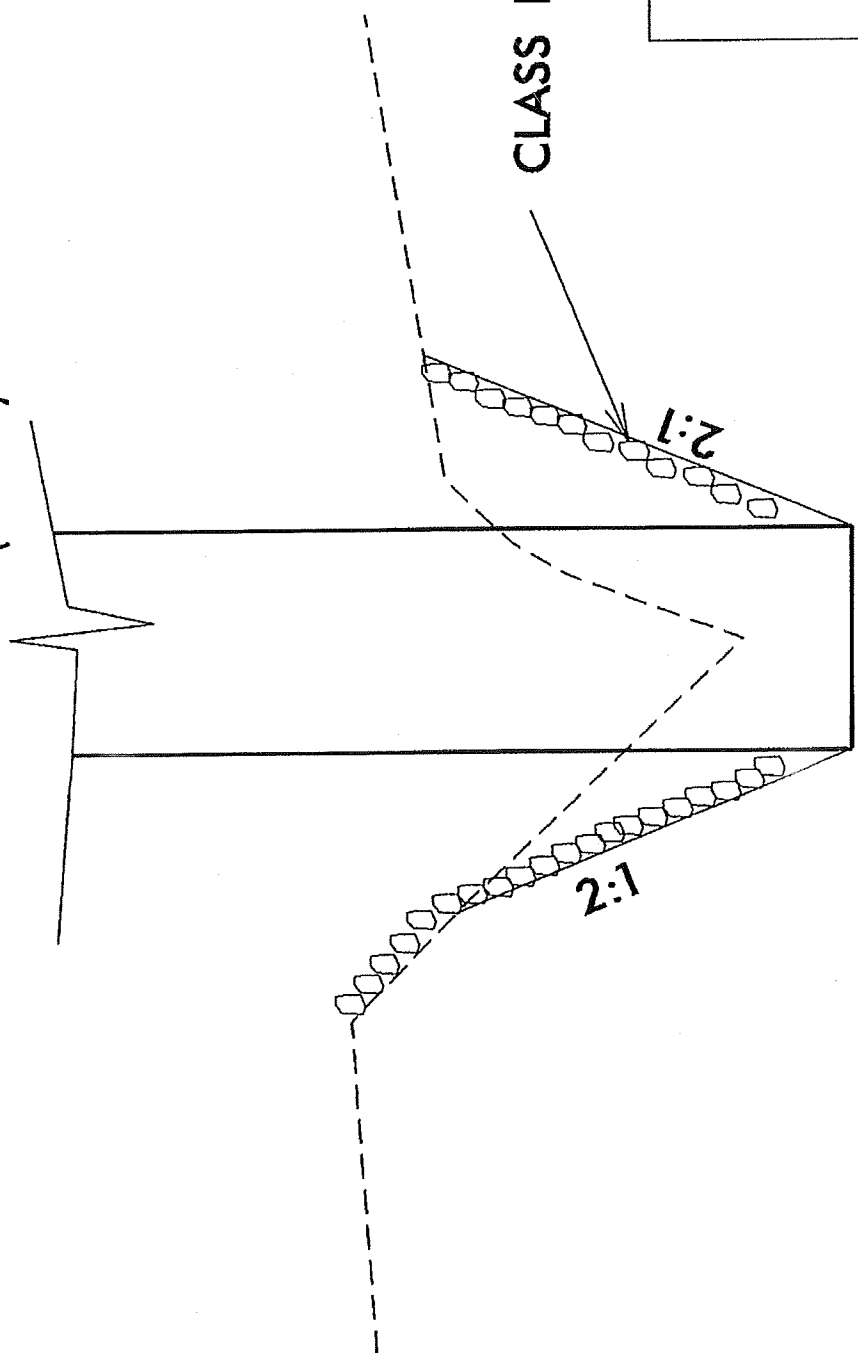

CLASS I RIP RAP ON BANKS

NCDOT
DIVISION OF HIGHWAYS
GUILFORD COUNTY
PROJECT: 34429.1.1 (R2413B)
NC 68 BETWEEN
SR 2127 (BROOKBANK ROAD)
AND NC 150

SHEET 21 OF 31 04/01/13

SITE 1

SITE 4

BANK
STABILIZATION
SEE DETAIL 'AM'

171.00 RT
NAD 83/NSRS 2007

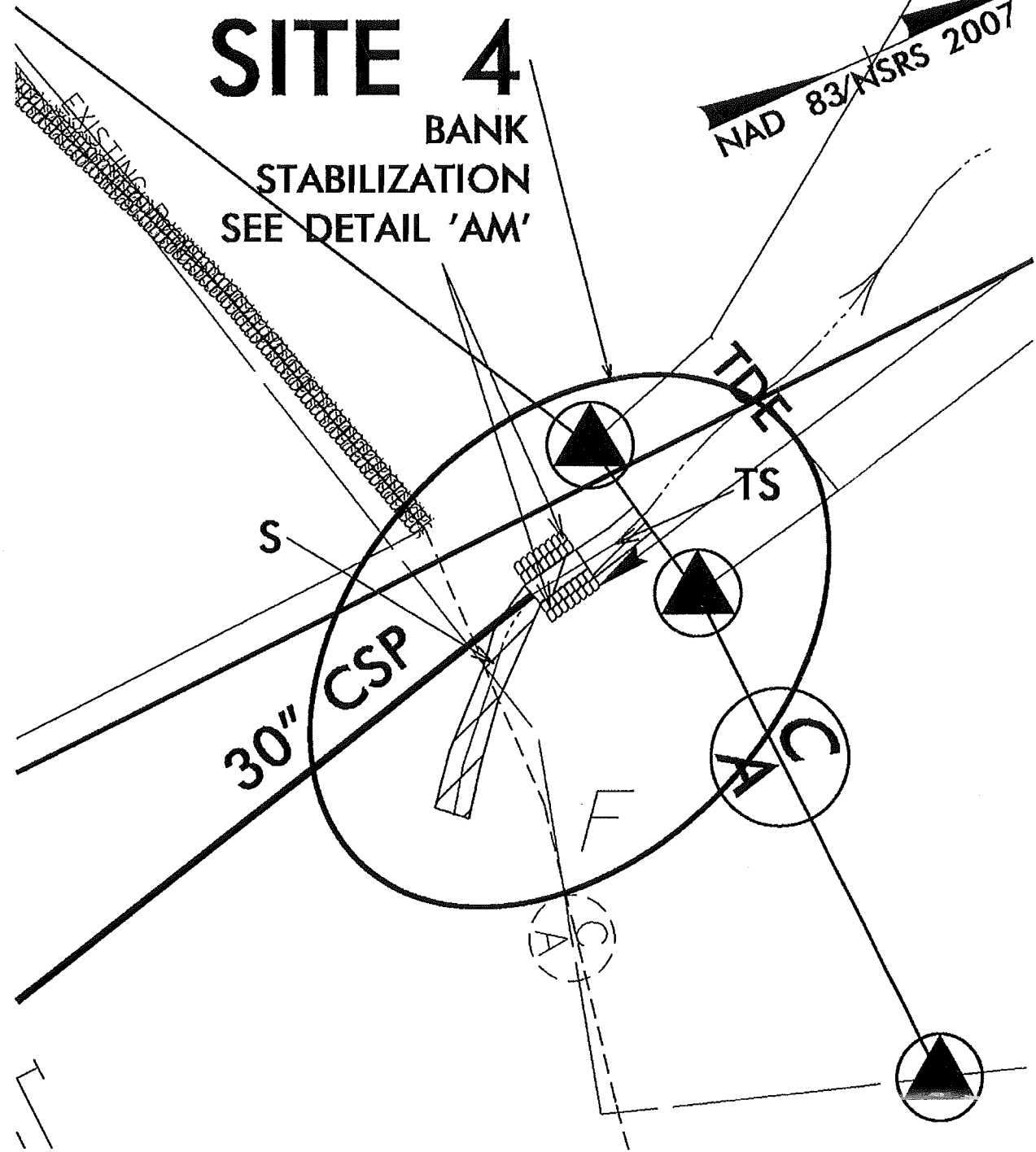

IMPACT ENLARGEMENT

 DENOTES IMPACTS IN SURFACE WATER

 DENOTES TEMPORARY IMPACTS IN SURFACE WATER

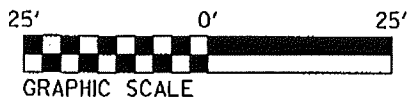

NCDOT

DIVISION OF HIGHWAYS
GUILFORD COUNTY

PROJECT: 34429.1.1 (R-2413B)

NC 68 BETWEEN
SR 2127 (BROOKBANK ROAD)
AND NC 150

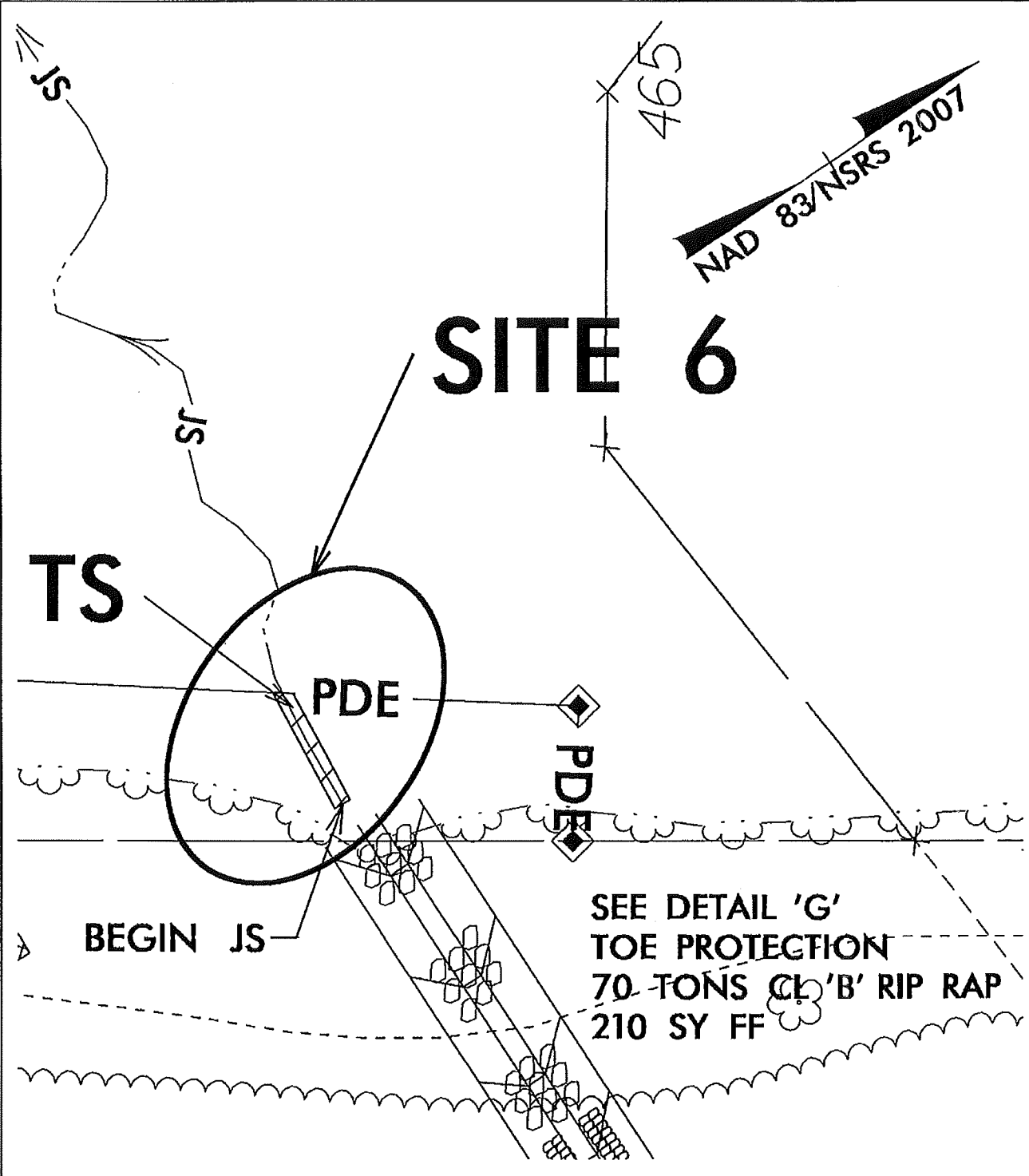

IMPACT ENLARGEMENT

 DENOTES TEMPORARY IMPACTS IN SURFACE WATER

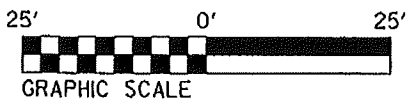

NCDOT
 DIVISION OF HIGHWAYS
 GUILFORD COUNTRY
 PROJECT: 34429.1.1 (R-2413B)
 NC 68 BETWEEN
 SR 2127 (BROOKBANK ROAD)
 AND NC 150

SHEET 23 OF 31

04/01/13

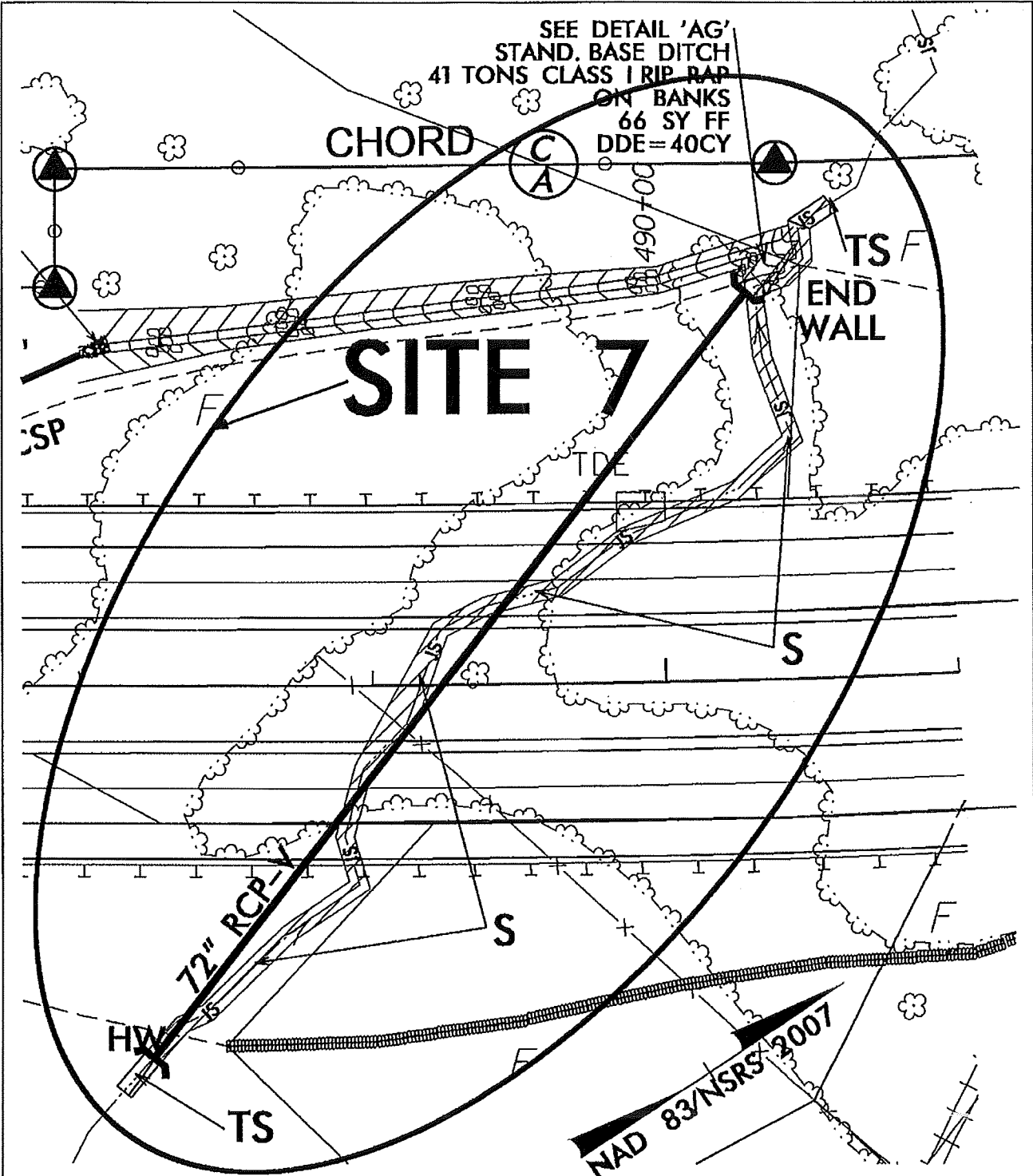

IMPACT ENLARGEMENT

S DENOTES IMPACTS IN SURFACE WATER

TS DENOTES TEMPORARY IMPACTS IN SURFACE WATER

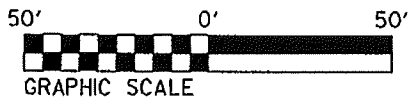

NCDOT
 DIVISION OF HIGHWAYS
 GUILFORD COUNTY
 PROJECT: 34429.1.1 (R-2413B)
 NC 68 BETWEEN
 SR 2127 (BROOKBANK ROAD)
 AND NC 150

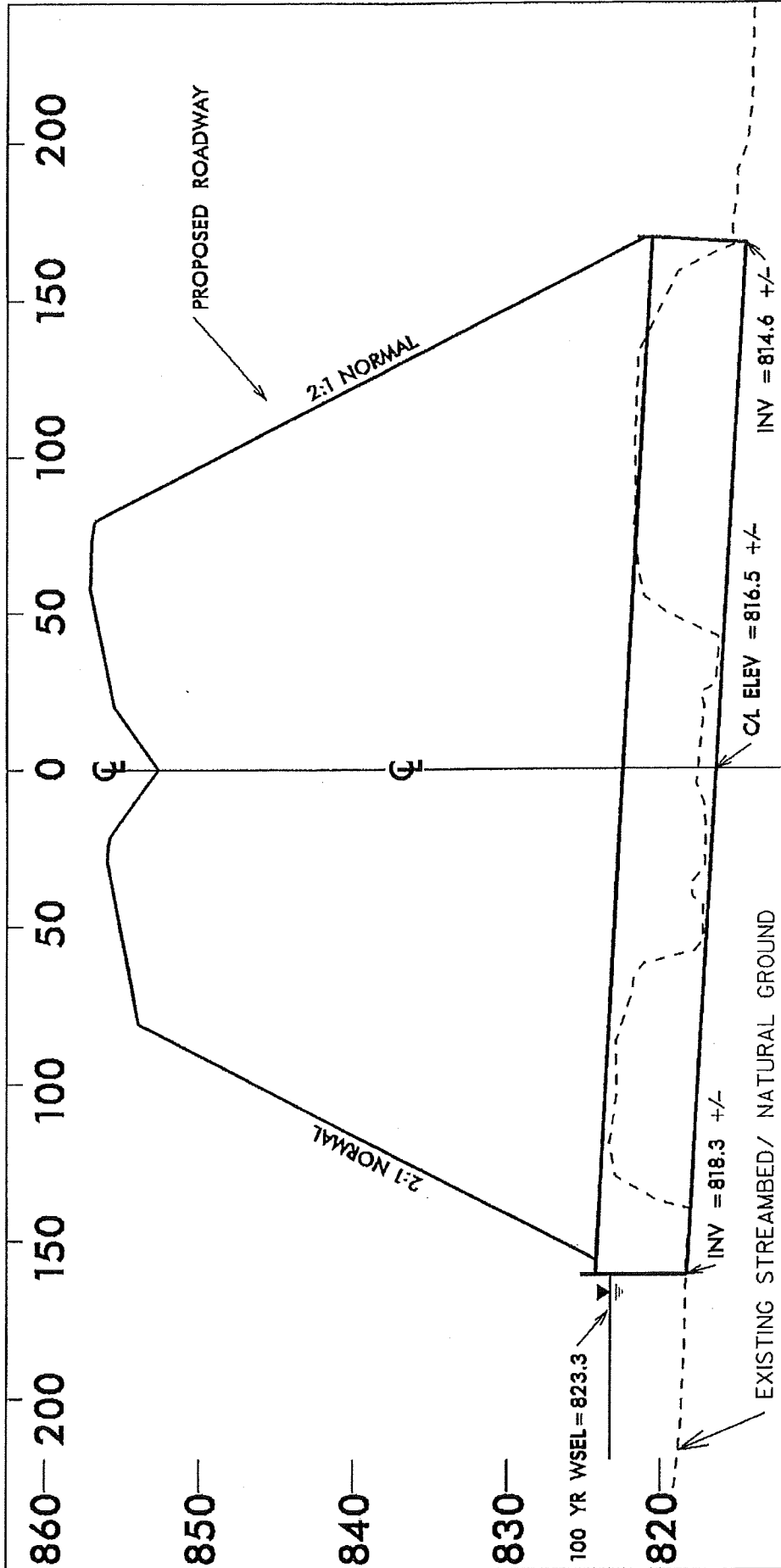

NCDOT
 DIVISION OF HIGHWAYS
 CABARRUS COUNTY
 PROJECT: 34429.11 (R-2413B)
 NC 68 BETWEEN
 SR 2127 (BROOKBANK ROAD)
 AND NC 150

PROFILE
 SITE 7

SCALE
 1:50' HORIZONTAL
 1:10' VERTICAL

SHEET 25 OF 31 04/01/13

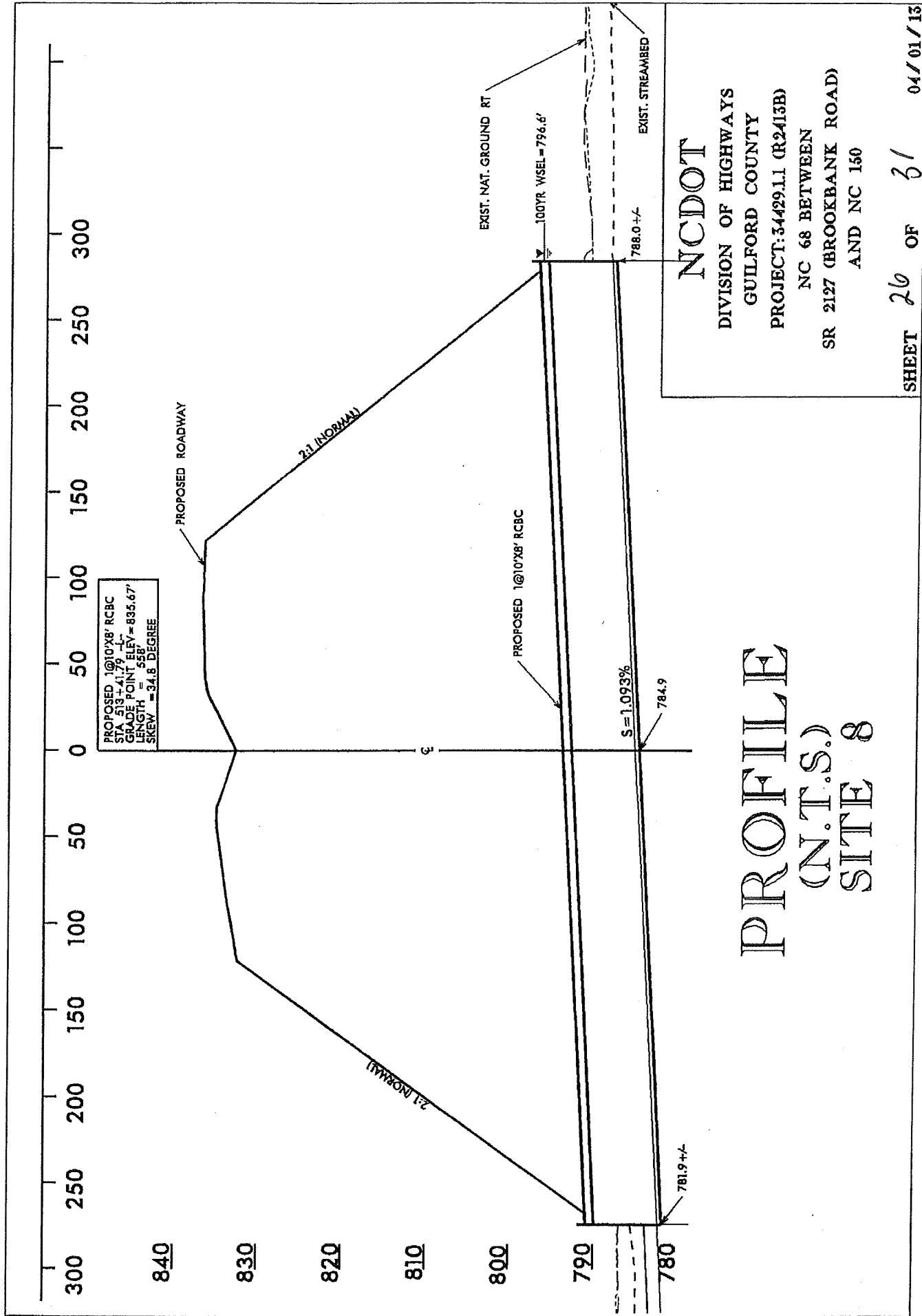

NCDOT

DIVISION OF HIGHWAYS
 GULFORD COUNTY
 PROJECT: 34429.1.1 (R2/13B)
 NC 68 BETWEEN
 SR 2127 (BROOKBANK ROAD)
 AND NC 150

PROFILE
 (N.T.S.)
SITE 8

511+00 512+00 513+00 514+00 515+00

PROPOSED 10'10"X8' RCBC
STA 513+41.79 -L-

UPSTREAM OF
PROPOSED
CULVERT

PROPOSED 10'X8' RCBC
-L- STA 513+45.00

100YR WSEL=796.6'

PROP. US
INV=788.0

CL -L- SECTION

830

820

810

800

790

NCDOT

DIVISION OF HIGHWAYS

GUILFORD COUNTY

PROJECT: 34429.11 (R2413B)

NC 68 BETWEEN

SR 2127 (BROOKBANK ROAD)

AND NC 150

SECTION

(N.T.S)

SITE 8

SHEET 27 OF 31

04/01/15

DETAIL OF ALTERNATING SILLS (N.T.S.)

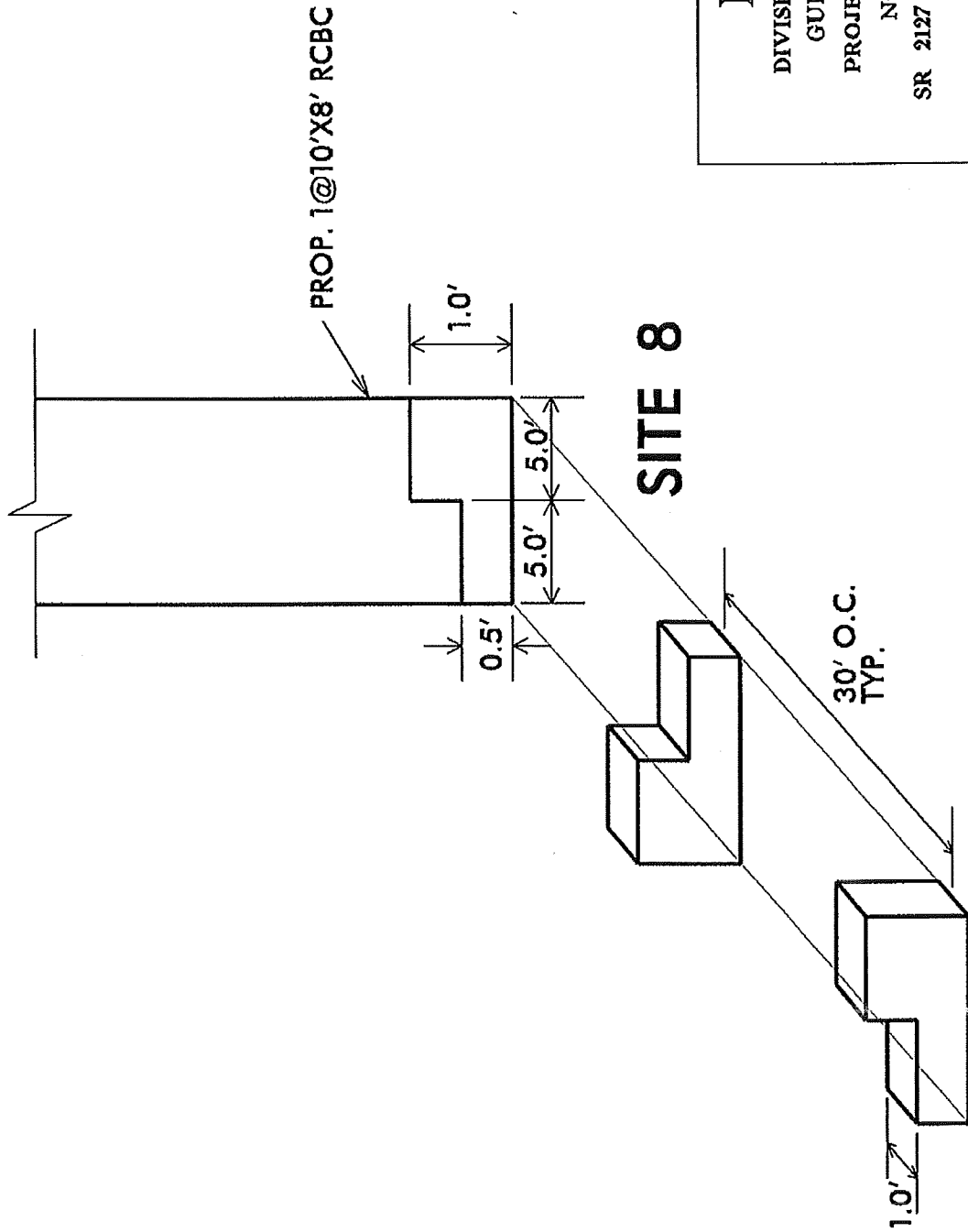

NC DOT

DIVISION OF HIGHWAYS
GUILFORD COUNTY

PROJECT: 34429.11 (R2413B)

NC 68 BETWEEN
SR 2127 (BROOKBANK ROAD)
AND NC 150

SHEET 28 OF 31

04/01/13

**DETAIL OF LOW FLOW
CHANNEL AND SILLS**
 -L- STA 513+41.79
 PROPOSED 1 @ 10'X8' RCBC
 UT TO HAW RIVER
 (not to scale) - SITE 8

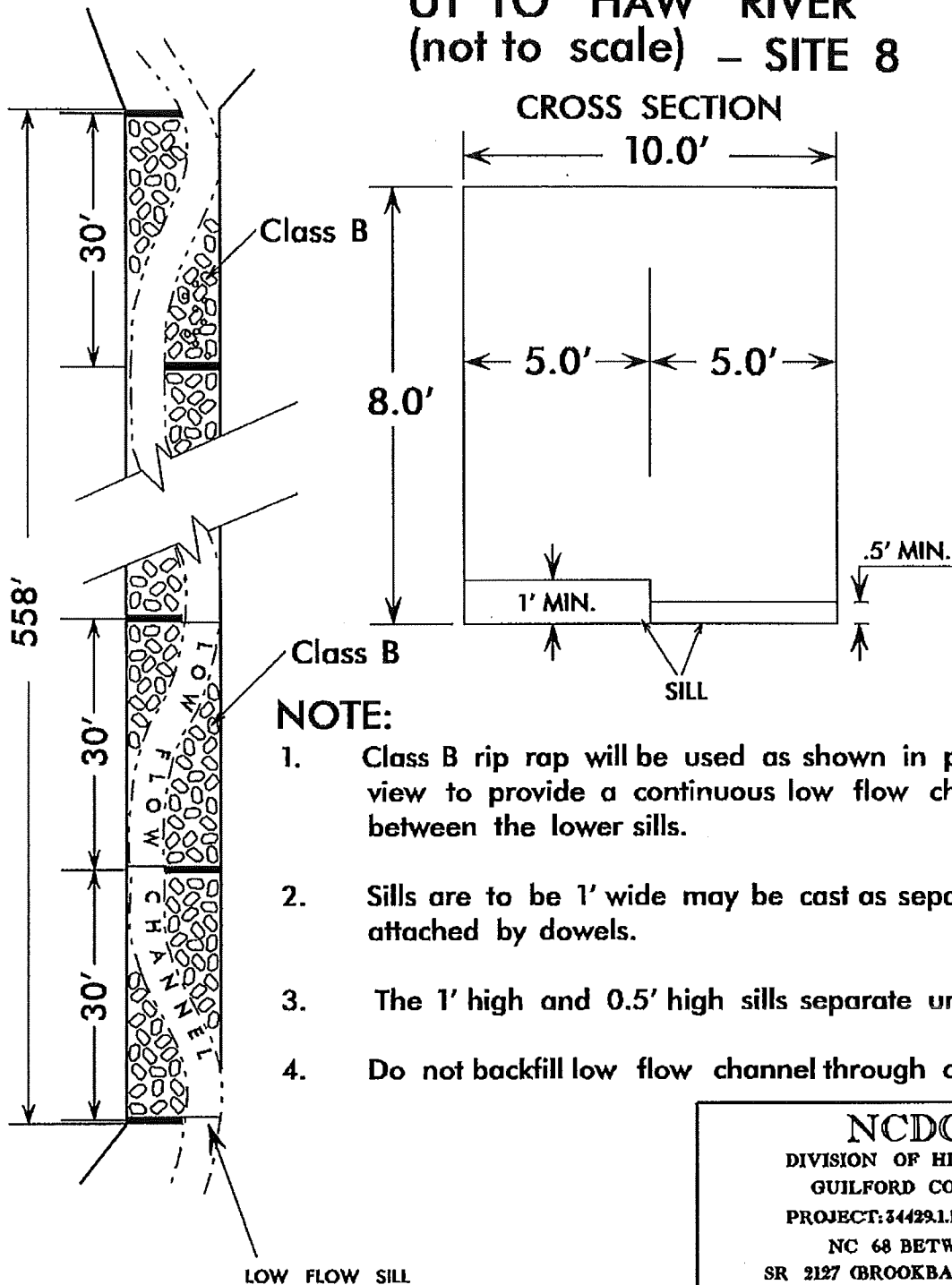

NOTE:

1. Class B rip rap will be used as shown in plan view to provide a continuous low flow channel between the lower sills.
2. Sills are to be 1' wide may be cast as separately and attached by dowels.
3. The 1' high and 0.5' high sills separate units.
4. Do not backfill low flow channel through culvert.

NCDOT
 DIVISION OF HIGHWAYS
 GUILFORD COUNTY
 PROJECT: 34429.1.1 (R2413B)
 NC 68 BETWEEN
 SR 2127 (BROOKBANK ROAD)
 AND NC 150

SHEET 29 OF 31 04/01/13

WETLAND PERMIT IMPACT SUMMARY

Site No.	Station (From/To)	Structure Size / Type	WETLAND IMPACTS					SURFACE WATER IMPACTS							
			Permanent Fill In Wetlands (ac)	Temp. Fill In Wetlands (ac)	Temp. Excavation in Wetlands (ac)	Mechanized Clearing in Wetlands (ac)	Hand Clearing in Wetlands (ac)	Permanent SW impacts (ac)	Temp. SW impacts (ac)	Existing Channel Impacts Permanent (ft)	Existing Channel Impacts Temp. (ft)	Natural Stream Design (ft)			
8	513+00 -L-	10' X 8' RCBC									0.06		645		
8a		Roadway Fill	0.02												
8b		Roadway Fill	0.03												
8c		Flood Plain Exc.			0.01										
8f	508+20 to 511+00 -L- Rt.	Stream Restoration													373
8d	517+25 to 519+11 -L- Lt.	Roadway Fill									0.03		339		
8g	515+75 to 519+43 -L- Lt.	Stream Relocation													392
8e	516+94 to 517+23 -L- Rt.	Roadway Fill									<0.01		29		
SUBTOTALS:			0.05		0.01						0.09		1013		765
TOTALS:			1.92		0.01					0.47		0.03	3441	197	765

NOTES:

NC DEPARTMENT OF TRANSPORTATION
DIVISION OF HIGHWAYS

GUILFORD COUNTY
WBS - 34429.1.1 (R-2413B)

***** STANDARD SPECIAL PROVISIONS *******PLANT AND PEST QUARANTINES****(Imported Fire Ant, Gypsy Moth, Witchweed, And Other Noxious Weeds)**

(3-18-03) (Rev. 8-31-13)

DB1 G130

Within Quarantined Area

This project may be within a county regulated for plant and/or pests. If the project or any part of the Design-Build Team's operations is located within a quarantined area, thoroughly clean all equipment prior to moving out of the quarantined area. Comply with federal/state regulations by obtaining a certificate or limited permit for any regulated article moving from the quarantined area.

Originating in a Quarantined County

Obtain a certificate or limited permit issued by the N.C. Department of Agriculture / United States Department of Agriculture. Have the certificate or limited permit accompany the article when it arrives at the project site.

Contact

Contact the N.C. Department of Agriculture/United States Department of Agriculture at 1-800-206-9333, 919-707-3730, or <http://www.ncagr.gov/plantind/> to determine those specific project sites located in the quarantined area or for any regulated article used on this project originating in a quarantined county.

Regulated Articles Include

1. Soil, sand, gravel, compost, peat, humus, muck, and decomposed manure, separately or with other articles. This includes movement of articles listed above that may be associated with cut/waste, ditch pulling, and shoulder cutting.
2. Plants with roots including grass sod.
3. Plant crowns and roots.
4. Bulbs, corms, rhizomes, and tubers of ornamental plants.
5. Hay, straw, fodder, and plant litter of any kind.
6. Clearing and grubbing debris.
7. Used agricultural cultivating and harvesting equipment.
8. Used earth-moving equipment.
9. Any other products, articles, or means of conveyance, of any character, if determined by an inspector to present a hazard of spreading imported fire ant, gypsy moth, witchweed or other noxious weeds.

GIFTS FROM VENDORS AND CONTRACTORS

(12-15-09)

DB1 G152

By Executive Order 24, issued by Governor Perdue, and *N.C. G.S. § 133-32*, it is unlawful for any vendor or contractor (i.e. architect, bidder, contractor, construction manager, design professional, engineer, landlord, offeror, seller, subcontractor, supplier, or vendor), to make gifts or to give favors to any State employee of the Governor’s Cabinet Agencies (i.e. Administration, Commerce, Correction, Crime Control and Public Safety, Cultural Resources, Environment and Natural Resources, Health and Human Services, Juvenile Justice and Delinquency Prevention, Revenue, Transportation, and the Office of the Governor). This prohibition covers those vendors and contractors who:

- (1) have a contract with a governmental agency; or
- (2) have performed under such a contract within the past year; or
- (3) anticipate bidding on such a contract in the future.

For additional information regarding the specific requirements and exemptions, vendors and contractors are encouraged to review Executive Order 24 and *G.S. § 133-32*.

Executive Order 24 also encouraged and invited other State Agencies to implement the requirements and prohibitions of the Executive Order to their agencies. Vendors and contractors should contact other State Agencies to determine if those agencies have adopted Executive Order 24.

STATE HIGHWAY ADMINISTRATOR TITLE CHANGE

07-31-12)

DB1 G185

Revise the 2012 *Standard Specifications for Roads and Structures* as follows:

Replace all references to “State Highway Administrator” with “Chief Engineer”.

BRIDGE APPROACH FILLS

(9-1-11)

DB4 R01

Description

Bridge approach fills include bridge approach fills for sub regional tier bridges and reinforced bridge approach fills. Construct bridge approach fills in accordance with the contract and *Roadway Standard Drawings* No. 422.10 or 422.11. Define “geosynthetics” as geotextiles or geomembranes.

Materials

Refer to Division 10 of the 2012 *Standard Specifications for Roads and Structures*.

Item	Section
Anchor Pins	1056-2
Geotextiles	1056
Portland Cement Concrete	1000
Select Material	1016

Subsurface Drainage Materials
Wire Staples

1044
1060-8(D)

For bridge approach fills for sub regional tier bridges, provide Type 1 geotextile for filtration geotextiles. For reinforced bridge approach fills, provide Type 5 geotextile for geotextile reinforcement and Type 1 geotextile and No. 78M stone for drains. Use Class B concrete for concrete pads.

Use Class III or V select material for reinforced bridge approach fills and only Class V select material (standard size No. 78M stone) for bridge approach fills for sub regional tier bridges. Provide PVC pipes, fittings and outlet pipes for subsurface drainage materials. For drains and PVC pipes behind end bents, use pipes with perforations that meet AASHTO M 278.

Use PVC, HDPE or linear low density polyethylene (LLDPE) geomembranes for reinforced bridge approach fills. For PVC geomembranes, provide grade PVC30 geomembranes that meet ASTM D7176. For HDPE and LLDPE geomembranes, use geomembranes with a nominal thickness of at least 30 mils that meet Geosynthetic Research Institute Standard Specifications GM13 or GM17, respectively. Handle and store geomembranes in accordance with Article 1056-2 of the 2012 *Standard Specifications for Roads and Structures*. Provide material certifications for geomembranes in accordance with Article 1056-3 of the 2012 *Standard Specifications for Roads and Structures*.

Construction Methods

Excavate as necessary for bridge approach fills in accordance with the contract. Notify the Engineer when foundation excavation is complete. Do not place geomembranes or filtration geotextiles until excavation dimensions and foundation material are approved. Attach geomembranes and filtration geotextiles to end bent cap back and wing walls with adhesives, tapes or other approved methods. Glue or weld geomembrane seams to prevent leakage.

For reinforced bridge approach fills, place geotextile reinforcement within 3" of locations shown in Standard Drawing No. 422.10 and in slight tension free of kinks, folds, wrinkles or creases. Install geotextile reinforcement with the orientation, dimensions and number of layers shown in Standard Drawing No. 422.10. Place first layer of geotextile reinforcement directly on geomembranes with no void or material in between. Install geotextile reinforcement with the machine direction (MD) parallel to the roadway centerline. The MD is the direction of the length or long dimension of the geotextile roll. Do not splice or overlap geotextile reinforcement in the MD so seams are perpendicular to the roadway centerline. Wrap geotextile reinforcement at end bent cap back and wing walls as shown in Standard Drawing No. 422.10 and directed by the Engineer. Extend geotextile reinforcement at least 4 feet back behind end bent cap back and wing walls into select material.

Overlap adjacent geotextiles at least 18" with seams oriented parallel to the roadway centerline. Hold geotextiles in place with wire staples or anchor pins as needed. Contact the Engineer when existing or future obstructions such as foundations, pavements, pipes, inlets or utilities will interfere with geosynthetics.

For reinforced bridge approach fills, construct one foot square drains consisting of 4" diameter

continuous perforated PVC pipes surrounded by No. 78M stone wrapped in Type 1 geotextiles. Install drains in accordance with Standard Drawing No. 422.10. For bridge approach fills for sub regional tier bridges, install 4" diameter continuous perforated PVC drain pipes in accordance with Standard Drawing No. 422.11.

Use solvent cement to connect PVC pipes so joints do not leak. Connect perforated pipes to outlet pipes just behind wing walls. Provide drain pipes and drains with positive drainage towards outlets. Place pipe sleeves in or under wing walls for outlet pipes so positive drainage is maintained. Use sleeves that can withstand wing wall loads.

Place select material in 8" to 10" thick lifts. Use only hand operated compaction equipment to compact select material for bridge approach fills. Compact Class III select material in accordance with Subarticle 235-3(C) of the 2012 *Standard Specifications for Roads and Structures*. Compact No. 78M stone with a vibratory compactor to the satisfaction of the Engineer. Do not displace or damage geosynthetics, drain pipes or drains when placing and compacting select material. End dumping directly on geosynthetics is not permitted. Do not operate heavy equipment on geosynthetics, drain pipes or drains until they are covered with at least 8" of select material. Replace any damaged geosynthetics, drain pipes or drains to the satisfaction of the Engineer.

Cover open ends of outlet pipes with rodent screens as shown in Standard Drawing No. 815.03. Connect ends of outlet pipes to concrete pads or existing drainage structures as directed by the Engineer. Construct concrete pads with an Ordinary surface finish that meets Subarticle 825-6(B) of the 2012 *Standard Specifications for Roads and Structures*.

AGGREGATE STABILIZATION

(11-19-13)

510

DB5 R10

Revise the 2012 *Standard Specifications for Roads and Structures* as follows:

Replace Section 510 with the following:

SECTION 510 AGGREGATE STABILIZATION

510-1 DESCRIPTION

Stabilize subgrades with aggregate base course (ABC) in accordance with the contract or as directed. Define "aggregate" as ABC for stabilizer aggregate or Class IV aggregate stabilization. Define "stabilizer aggregate" as mixing aggregate with subgrade soils. Define "Class IV aggregate stabilization" as replacing subgrade soils with aggregate. Remove material as needed in cut areas. Install geotextile for soil stabilization as needed and place aggregate at locations shown on the plans developed by the Design-Build Team.

510-2 MATERIALS

Refer to Division 10.

Item	Section
Aggregate for Stabilization	1008
Geotextile for Soil Stabilization, Type 4	1056
Select Material, Class IV	1016

Use aggregate for stabilization for stabilizer aggregate and Class IV select material for Class IV aggregate stabilization.

510-3 CONSTRUCTION METHODS

When undercut is required for aggregate stabilization, undercut as needed to place aggregate as shown on the plans developed by the Design-Build Team or as directed. Perform undercut excavation in accordance with Section 225.

(A) Stabilizer Aggregate

Spread aggregate uniformly and evenly with a mechanical spreader to the required thickness. Do not spread more aggregate than what can be mixed and compacted within a week. Mix aggregate with the top 3" of subgrade soils until aggregate and soils are uniformly mixed. Compact stabilizer aggregate to 100% of AASHTO T 99 as modified by the Department.

(B) Class IV Aggregate Stabilization

When geotextile for soil stabilization is required, install geotextiles in accordance with Article 270-3. Place aggregate by end dumping aggregate on geotextiles or subgrade soils. Do not operate heavy equipment on geotextiles until geotextiles are covered with the required thickness of aggregate. Compact Class IV aggregate stabilization less than 6" thick with a smooth wheeled roller without vibration to the satisfaction of the Engineer. Compact Class IV aggregate stabilization with a thickness of 6" or more to 92% of AASHTO T 180 as modified by the Department or to the highest density that can be reasonably obtained.

(C) Maintenance

Maintain aggregate stabilization in an acceptable condition and minimize the use of heavy equipment on aggregate in order to avoid damaging subgrades. Provide and maintain drainage ditches and drains as required to prevent entrapping water in aggregate stabilization.

PREPARATION OF SUBGRADE AND BASE

(9-1-11)

DB5 R05

On mainline portions and ramps of this project, prepare the subgrade and base beneath the pavement structure in accordance with the applicable sections of the 2012 *Standard Specifications for Roads and Structures* except use an automatically controlled fine grading machine utilizing string lines, laser controls, or other approved methods to produce final subgrade and base surfaces meeting the lines, grades, and cross sections required by the **plans** developed by the Design-Build Team or established by the Engineer.

ASPHALT PAVEMENTS - SUPERPAVE

(8-31-13)

605, 609, 610, 650

DB 6 R01

Revise the 2012 *Standard Specifications for Roads and Structures* as follows:

Page 6-3, Article 605-7 APPLICATION RATES AND TEMPERATURES, replace this article, including Table 601-1, with the following:

Apply tack coat uniformly across the existing surface at target application rates shown in Table 605-1.

TABLE 605-1 APPLICATION RATES FOR TACK COAT	
Existing Surface	Target Rate (gal/sy)
	Emulsified Asphalt
New Asphalt	0.04 ± 0.01
Oxidized or Milled Asphalt	0.06 ± 0.01
Concrete	0.08 ± 0.01

Apply tack coat at a temperature within the ranges shown in Table 605-2. Tack coat shall not be overheated during storage, transport or at application.

TABLE 605-2 APPLICATION TEMPERATURE FOR TACK COAT	
Asphalt Material	Temperature Range
Asphalt Binder, Grade PG 64-22	350 - 400°F
Emulsified Asphalt, Grade RS-1H	130 - 160°F
Emulsified Asphalt, Grade CRS-1	130 - 160°F
Emulsified Asphalt, Grade CRS-1H	130 - 160°F
Emulsified Asphalt, Grade HFMS-1	130 - 160°F
Emulsified Asphalt, Grade CRS-2	130 - 160°F

Page 6-7, Article 609-3 FIELD VERIFICATION OF MIXTURE AND JOB MIX FORMULA ADJUSTMENTS, Lines 35-37, delete the second sentence of the second paragraph.

Page 6-18, Article 610-1 DESCRIPTION, Lines 40-41, delete the last sentence of the last paragraph.

Page 6-19, Subarticle 610-3(A) Mix Design-General, Line 5, add the following as the first paragraph:

Warm mix asphalt (WMA) is allowed for use at the Contractor’s option in accordance with the NCDOT Approved Products List for WMA Technologies available at:

<https://connect.ncdot.gov/resources/Materials/MaterialsResources/Warm%20Mix%20Asphalt%20Approved%20Lists.pdf>

Page 6-21, Subarticle 610-3(C) Job Mix Formula (JMF), replace Table 610-1 with the following:

TABLE 610-1 DESIGN MIXING TEMPERATURE AT THE ASPHALT PLANT^A		
Binder Grade	HMA JMF Temperature	WMA JMF Temperature Range
PG 64-22	300°F	225 - 275°F
PG 70-22	315°F	240 - 290°F
PG 76-22	335°F	260 - 310°F

A. The mix temperature, when checked in the truck at the roadway, shall be within plus 15° and minus 25° of the temperature specified on the JMF.

Page 6-21, Subarticle 610-3(C) Job Mix Formula (JMF), Lines 4-6, delete first sentence of the second paragraph. Line 7, in the second sentence of the second paragraph, replace “275°F” with “275°F or greater.”

Page 6-22, Article 610-4 WEATHER, TEMPERATURE AND SEASONAL LIMITATIONS FOR PRODUCING AND PLACING ASPHALT MIXTURES, Lines 15-17, replace the second sentence of the first paragraph with the following:

Do not place asphalt material when the air or surface temperatures, measured at the location of the paving operation away from artificial heat, do not meet Table 610-5.

Page 6-23, Article 610-4 WEATHER, TEMPERATURE AND SEASONAL LIMITATIONS FOR PRODUCING AND PLACING ASPHALT MIXTURES, replace Table 610-5 with the following:

TABLE 610-5 PLACEMENT TEMPERATURES FOR ASPHALT	
Asphalt Concrete Mix Type	Minimum Surface and Air Temperature
B25.0B, C	35°F
I19.0B, C, D	35°F
SF9.5A, S9.5B	40°F
S9.5C, S12.5C	45°F
S9.5D, S12.5D	50°F

Page 6-26, Article 610-7 HAULING OF ASPHALT MIXTURE, Lines 22-23, in the fourth sentence of the first paragraph replace “so as to overlap the top of the truck bed and” with “to”.

Page 6-41, Subrticle 650-3(B) Mix Design Criteria, replace Table 650-1 with the following:

TABLE 650-1 OGAFC GRADATION CRITERIA			
Grading Requirements	Total Percent Passing		
<i>Sieve Size (mm)</i>	<i>Type FC-1</i>	<i>Type FC-1 Modified</i>	<i>Type FC-2 Modified</i>
19.0	-	-	100
12.5	100	100	80 - 100
9.50	75 - 100	75 - 100	55 - 80
4.75	25 - 45	25 - 45	15 - 30
2.36	5 - 15	5 - 15	5 - 15
0.075	1.0 - 3.0	1.0 - 3.0	2.0 - 4.0

Page 6-50, Table 660-1 MATERIAL APPLICATION RATES AND TEMPERATURES, Lines 1-2, replace Note A in Table 660-1 with the following:

- A. Use No. 6M, No. 67, No. 5 and No. 78M aggregate for retreatment before an asphalt overlay on existing pavement based on the width of the cracks in the existing pavement. Choose No. 78M for sections of roadway where the average width of existing cracks is 1/4" or less in width, No. 67 for sections of roadway where the average width of existing cracks are 1/4" to 5/8" in width and choose No. 5 for sections of roadway where the existing crack widths are greater than 5/8".

ASPHALT BINDER CONTENT OF ASPHALT PLANT MIXES

(6-07-12)

DB6 R15

The approximate asphalt binder content of the asphalt concrete plant mixtures used on this project will be as follows:

Asphalt Concrete Base Course	Type B 25.0_	4.4%
Asphalt Concrete Intermediate Course	Type I 19.0_	4.8%
Asphalt Concrete Surface Course	Type S 4.75A	6.8%
Asphalt Concrete Surface Course	Type SA-1	6.8%
Asphalt Concrete Surface Course	Type SF 9.5A	6.7%
Asphalt Concrete Surface Course	Type S 9.5_	6.0%
Asphalt Concrete Surface Course	Type S 12.5_	5.6%

The actual asphalt binder content will be established during construction by the Engineer within the limits established in the 2012 *Standard Specifications for Roads and Structures*.

ASPHALT PLANT MIXTURES

(07-01-95)

DB6 R20

Place asphalt concrete base course material in trench sections with asphalt pavement spreaders made for the purpose or with other equipment approved by the Engineer.

FINAL SURFACE TESTING

(9-1-11)

DB6 R45

On the all mainline, auxiliary lanes, acceleration and deceleration lanes, ramps, and loops and on all -Y- lines with two or more layers of asphalt and greater than 2500 feet in length, perform smoothness acceptance testing of the longitudinal profile of the finished pavement surface using an Inertial Profiler in accordance with Article 610-13 and Article 710-7 of the 2012 *Standard Specifications for Roads and Structures*. The North Carolina Hearne Straightedge will not be permitted.

Replace Tables 610-7 and 710-1 of the 2012 *Standard Specifications for Roads and Structures* with the following Table.

MRI VALUES PER 0.10-MILE SECTION	
MRI after Completion (Inches Per Mile)	Price Adjustment Per Lane (0.10-Mile Section)
70.0 and Under	Acceptable (No pay adjustment)
70.1-90.0	PA = 650 – (10 * MRI)
Over 90.1	Corrective Action Required

Page 6-34, Replace Table 610-8 with the following:

Adjustment Schedule for Cumulative Straightedge Index (CSI) (Obtained by adding SE Index of up to 25 consecutive 100-foot sections)		
*CSI	ACCEPTANCE CATEGORY	CORRECTIVE ACTION
0-0	Acceptable	None
1-0 or 2-0	Acceptable	None
3-0 or 4-0	Acceptable	None
Any Other Number	Unacceptable	Required

***Either Before or After Corrective Actions**

Page 6-35, Replace the 14th paragraph of Article 610-13(B) with the following:

Correct any deviation that exceeds a 0.3 inch blanking band such that the deviation is reduced to 0.2 inches or less.

Page 6-35, Replace the 16th, 17th, 18th, and 19th paragraphs of Article 610-13(B) with the following:

Take corrective actions as specified if the CSI indicates “Required” corrective action. The CSI after corrective action should meet or exceed “Acceptable” requirements.

Where corrective action is required, the test section(s) requiring corrective action will be retested, unless the Engineer directs the retesting of the entire lot.

Test sections and / or lots that are initially tested by the Design-Build Team which indicate excessive deviations such that corrective action is required, may be re-rolled with asphalt rollers while the mix is still warm and in a workable condition, to possibly correct the problem. In this instance, reevaluation of the test section(s) must be completed within 24 hours of pavement placement and these test results will serve as the initial test results.

OPEN GRADED ASPHALT FRICTION COURSE, PERMEABLE ASPHALT DRAINAGE COURSE, AND ULTRA-THIN BONDED WEARING COURSE

(4-17-12)

609

DB6 R62

When producing and constructing open graded asphalt friction course, permeable asphalt drainage course, and ultra-thin bonded wearing course revise the 2012 *Standard Specifications for Roads and Structures* as follows:

Page 6-10, Subarticle 609-6(B) Required Sampling and Testing Frequencies, delete the third paragraph and replace with the following:

Sample and test the completed mixture from each mix design per plant per year at the following minimum frequency during mix production:

<u>Accumulative Production Increment</u>	<u>Number of Samples per Increment</u>
500 tons	1

Page 6-10, Subarticle 609-6(C) Control Charts, delete the fourth paragraph and replace with the following:

Record the following data on the standardized control charts and in accordance with the requirements of Section 7.4 of the *HMA/QMS Manual*:

- (a) Aggregate Gradation Test Results:
 - 1. 12.5 mm (Types P57 & FC-2 Mod. Only)
 - 2. 9.5 mm (Excluding Type P57)
 - 3. 4.75 mm
 - 4. 2.36 mm
 - 5. 0.075 mm Sieves
- (b) Binder Content, %, P_b

Page 6-11, Subarticle 609-6(D) Control Limits, Table 609-1 CONTROL LIMITS, replace with the following:

TABLE 609-1 CONTROL LIMITS			
Mix Control Criteria	Target Source	Moving Average Limit	Individual Limit
12.5 mm Sieve (Types P57 & FC-2 Mod)	JMF	± 4.0	± 8.0
9.5 mm Sieve (Excluding Type P57)	JMF	± 4.0	± 8.0
4.75 mm Sieve	JMF	± 4.0	± 8.0
2.36 mm Sieve	JMF	± 4.0	± 8.0
0.075 mm Sieve	JMF	± 1.5	± 2.5
Binder Content	JMF	± 0.3	± 0.7
TSR (Ultra-thin Only)	Min. Spec. Limit	-	- 15%

Page 6-12, Subarticle 609-6(F) Allowable Retesting for Mix Deficiencies, Table 609-2 RETEST LIMITS FOR MIX DEFICIENCIES, replace with the following:

TABLE 609-2 RETEST LIMITS FOR MIX DEFICIENCIES	
Property	Limit
% Binder Content	by more than ± 1.0%
12.5 mm Sieve (Types P 57 & FC-2 Mod)	by more than ± 9.0%
9.5 mm Sieve (Excluding Type P 57)	by more than ± 9.0%
4.75 mm sieve	by more than ± 9.0%
2.36 mm sieve	by more than ± 9.0%
0.075 mm sieve	by more than ± 3.0%
TSR (Ultra-thin only)	by more than -15% from Specification limit

Page 6-17, Subarticle 609-9(C) Limits of Precision, Table 609-3 LIMITS OF PRECISION FOR TEST RESULTS, replace with the following:

TABLE 609-3 LIMITS OF PRECISION FOR TEST RESULTS	
Mix Property	Limits of Precision
12.5 mm Sieve (Types P 57 & FC-2 Mod. Only)	± 6.0%
9.5 mm Sieve (Excluding Type P 57)	± 5.0%
4.75 mm Sieve	± 5.0%
2.36 mm Sieve	± 5.0%
0.075 mm Sieve	± 2.0%
Asphalt Binder Content	± 0.5%
TSR (Ultra-thin HMA Only)	± 15.0%

SUBSURFACE DRAINAGE

(9-1-11)

DB8 R05

Revise the 2012 *Standard Specifications for Roads and Structures* as follows:

Page 8-11, Article 815-1, Delete the first sentence and replace with the following:

The Design-Build Team shall construct subsurface drains, underdrains, blind drains and other types of drains where groundwater is within 6 feet of subgrade.

GUARDRAIL ANCHOR UNITS, TYPE M-350

(9-1-11)

DB8 R60

Description

Furnish and install guardrail anchor units in accordance with the details in the plans developed by the Design-Build Team, the applicable requirements of Section 862 of the 2012 *Standard Specifications for Roads and Structures*, and at locations shown in the plans developed by the Design-Build Team.

Materials

The Design Build Team may, at his option, furnish any one of the following guardrail anchor units or approved equal.

The guardrail anchor unit (SRT-350) as manufactured by:

TRINITY INDUSTRIES, INC.
2525 N. STEMMONS FREEWAY
DALLAS, TEXAS 75207
TELEPHONE: 800 644-7976

The guardrail anchor unit (FLEAT) as manufactured by:

ROAD SYSTEMS, INC.
3616 OLD HOWARD COUNTY AIRPORT
BIG SPRINGS, TEXAS 79720
TELEPHONE: 915-263-2435

The guardrail anchor unit (REGENT) as manufactured by:

ENERGY ABSORPTION SYSTEMS, INC.
ONE EAST WACKER DRIVE
CHICAGO, ILLINOIS 60601-2076
TELEPHONE: 888-32-ENERGY

Prior to installation the Design Build Team shall submit to the Engineer:

1. FHWA acceptance letter for each guardrail anchor unit certifying it meets the requirements of NCHRP Report 350, Test Level 3, in accordance with Section 106-2 of the 2012 *Standard Specifications for Roads and Structures*.
2. Certified working drawings and assembling instructions from the manufacturer for each guardrail anchor unit in accordance with Section 105-2 of the 2012 *Standard Specifications for Roads and Structures*.

No modifications shall be made to the guardrail anchor unit without the express written permission from the manufacturer. Perform installation in accordance with the details in the plans developed by the Design-Build Team, and details and assembling instructions furnished by the manufacturer.

Construction

Guardrail end delineation is required on all approach and trailing end sections for both temporary and permanent installations. Guardrail end delineation consists of yellow reflective sheeting applied to the entire end section of the guardrail in accordance with Section 1088-3 of the 2012 *Standard Specifications for Roads and Structures* and is incidental to the cost of the guardrail anchor unit.

GUARDRAIL ANCHOR UNITS, TYPE 350

(9-1-11)

DB8 R65

Description

Furnish and install guardrail anchor units in accordance with the details in the plans as developed by the Design-Build Team, the applicable requirements of Section 862 of the 2012 *Standard Specifications for Roads and Structures*, and at locations shown in the plans developed by the Design-Build Team.

Materials

The Design-Build Team may at his option, furnish any one of the guardrail anchor units or approved equal.

Guardrail anchor unit (ET-2000) as manufactured by:

TRINITY INDUSTRIES, INC.
2525 N. STEMMONS FREEWAY
DALLAS, TEXAS 75207
TELEPHONE: 800-644-7976

The guardrail anchor unit (SKT 350) as manufactured by:

ROAD SYSTEMS, INC.
3616 OLD HOWARD COUNTY AIRPORT
BIG SPRING, TEXAS 79720
TELEPHONE: 915 263-2435

Prior to installation the Design-Build Team shall submit to the Engineer:

1. FHWA acceptance letter for each guardrail anchor unit certifying it meets the requirements of NCHRP Report 350, Test Level 3, in accordance with Section 106-2 of 2012 *Standard Specifications for Roads and Structures*.
2. Certified working drawings and assembling instructions from the manufacturer for each guardrail anchor unit in accordance with Section 105-2 of the 2012 *Standard Specifications for Roads and Structures*.

No modifications shall be made to the guardrail anchor unit without the express written permission from the manufacturer. Perform installation in accordance with the details in the plans developed by the Design-Build Team, and details and assembling instructions furnished by the manufacturer.

Construction

Guardrail end delineation is required on all approach and trailing end sections for both temporary and permanent installations. Guardrail end delineation consists of yellow reflective sheeting applied to the entire end section of the guardrail in accordance with Section 1088-3 of the 2012 *Standard Specifications for Roads and Structures* and is incidental to the cost of the guardrail anchor unit.

IMPACT ATTENUATOR UNITS, TYPE 350

(9-1-11)

DB8 R75

Description

Furnish and install impact attenuator units and any components necessary to connect the impact attenuator units in accordance with the manufacturer's requirement, the details in the plans developed by the Design-Build Team and at locations shown in the plans developed by the Design-Build Team.

Materials

The Design-Build Team may at his option, furnish any one of the impact attenuator units or approved equal:

NON-GATING IMPACT ATTENUATOR UNITS:

The impact attenuator unit (QUADGUARD) as manufactured by:

ENERGY ABSORPTION SYSTEMS, INC.
ONE EAST WACKER DRIVE
CHICAGO, ILLINOIS 60601-2076
TELEPHONE: 312-467-6750

The impact attenuator unit (TRACC) as manufactured by:

TRINITY INDUSTRIES, INC.
2525 N. STEMMONS FREEWAY
DALLAS, TEXAS 75207
TELEPHONE: 1-800-644-7976

GATING IMPACT ATTENUATOR UNITS:

The impact attenuator unit (BRAKEMASTER) as manufactured by:

ENERGY ABSORPTION SYSTEMS, INC.
ONE EAST WACKER DRIVE
CHICAGO, ILLINOIS 60601-2076
TELEPHONE: 312-467-6750

The impact attenuator unit (CAT) as manufactured by:

TRINITY INDUSTRIES, INC.
2525 N. STEMMONS FREEWAY
DALLAS, TEXAS 75207
TELEPHONE: 1-800-644-7976

Prior to installation the Design-Build Team shall submit to the Engineer:

1. FHWA acceptance letter for each impact attenuator unit certifying it meets the requirements of NCHRP Report 350, Test Level 3, in accordance with Section 106-2 of the 2012 *Standard Specifications for Roads and Structures*.
2. Certified working drawings and assembling instructions from the manufacturer for each impact attenuator unit in accordance with Section 105-2 of the 2012 *Standard Specifications for Roads and Structures*.

No modifications shall be made to the impact attenuator unit without the express written permission from the manufacturer. Perform installation in accordance with the details in the plans developed by the Design-Build Team, and details and assembling instructions furnished by the manufacturer.

Construction Methods

If the median width is 40 feet or less, the Design-Build Team shall supply one of the NON-GATING Impact Attenuator Units listed in the Materials Section herein.

If the median width is greater than 40 feet, the Design-Build Team may use any of the GATING or NON-GATING Impact Attenuator Units listed in the Materials Section herein.

PREFORMED SCOUR HOLE WITH LEVEL SPREADER APRON

(08-24-09)

DB8 R105

Description

Construct and maintain preformed scour holes with spreader aprons at the locations shown on the plans developed by the Design-Build Team and in accordance with the details in the plans developed by the Design-Build Team. Work includes excavation, shaping and maintaining the hole and apron, furnishing and placing filter fabric, rip rap (class as specified in the plans developed by the Design-Build Team) and permanent soil reinforcement matting.

Materials

Item	Section
Plain rip rap	1042
Filter Fabric	1056

The permanent soil reinforcement matting shall be permanent erosion control reinforcement mat and shall be constructed of synthetic or a combination of coconut and synthetic fibers evenly distributed throughout the mat between a bottom UV stabilized netting and a heavy duty UV stabilized top net. The matting shall be stitched together with UV stabilized polypropylene thread to form a permanent three dimensional structure. The mat shall have the following minimum physical properties:

Property	Test Method	Value Unit
Light Penetration	ASTM D6567	9 %
Thickness	ASTM D6525	0.40 in
Mass Per Unit Area	ASTM D6566	0.55 lb/sy
Tensile Strength	ASTM D6818	385 lb/ft
Elongation (Maximum)	ASTM D6818	49 %
Resiliency	ASTM D1777	>70 %
UV Stability *	ASTM 4355	≥80 %
Porosity (Permanent Net)	ECTC Guidelines	≥85 %
Maximum Permissible Shear Stress (Vegetated)	Performance Bench Test	≥8.0 lb/ft ²
Maximum Allowable Velocity (Vegetated)	Performance Bench Test	≥16.0 ft/s

*ASTM D1682 Tensile Strength and % strength retention of material after 1000 hours of exposure.

A certification (Type 1, 2, or 3) from the manufacturer showing:

- (A) the chemical and physical properties of the mat used, and
- (B) conformance of the mat with this specification will be required.

Construction Methods

All areas to be protected with the mat shall be brought to final grade and seeded in accordance with Section 1660 of the *Standard Specifications*. The surface of the soil shall be smooth, firm, stable and free of rocks, clods, roots or other obstructions that would prevent the mat from lying in direct contact with the soil surface. Areas where the mat is to be placed will not need to be mulched.

STREET SIGNS AND MARKERS AND ROUTE MARKERS

(07-01-95)

DB9 R01

Move any existing street signs, markers, and route markers out of the construction limits of the project and install the street signs and markers and route markers so that they will be visible to the traveling public if there is sufficient right of way for these signs and markers outside of the construction limits.

Near the completion of the project and when so directed by the Engineer, move the signs and markers and install them in their proper location in regard to the finished pavement of the project.

Stockpile any signs or markers that cannot be relocated due to lack of right of way, or any signs and markers that will no longer be applicable after the construction of the project, at locations directed by the Engineer for removal by others.

The Design-Build Team shall be responsible to the owners for any damage to any street signs and markers or route markers during the above described operations.

MATERIALS

(2-21-12) (Rev. 12-15-13)

1000, 1005, 1024, 1050, 1056, 1074, 1078, 1080, 1081, 1084, 1086, 1087, 1092

DB10 R01

Revise the 2012 *Standard Specifications for Roads and Structures* as follows:

Page 10-1, Article 1000-1, DESCRIPTION, Lines 9-10, replace the last sentence of the first paragraph with the following:

Type IL, IP, IS or IT blended cement may be used instead of Portland cement.

Page 10-1, Article 1000-1, DESCRIPTION, Line 14, add the following:

Use materials which do not produce a mottled appearance through rusting or other staining of the finished concrete surface.

Page 10-1, Article 1000-2, MATERIALS, Line 16, add the following to the table of item references:

Item
Type II, Blended Cement

Section
1024-1

Page 10-5, Table 1000-1, REQUIREMENTS FOR CONCRETE, replace with the following:

TABLE 1000-1 REQUIREMENTS FOR CONCRETE											
Class of Concrete	Min. Comp. Strength at 28 days	Maximum Water-Cement Ratio				Consistency Max. Slump		Cement Content			
		Air-Entrained Concrete		Non Air- Entrained Concrete		Vibrated	Non- Vibrated	Vibrated		Non- Vibrated	
		Rounded Aggregate	Angular Aggre- gate	Rounded Aggregate	Angular Aggre- gate			Min.	Max.	Min.	Max.
<i>Units</i>	<i>psi</i>					<i>inch</i>	<i>inch</i>	<i>lb/cy</i>	<i>lb/cy</i>	<i>lb/cy</i>	<i>lb/cy</i>
AA	4,500	0.381	0.426	-	-	3.5	-	639	715	-	-
AA Slip Form	4,500	0.381	0.426	-	-	1.5	-	639	715	-	-
Drilled Pier	4,500	-	-	0.450	0.450	-	5-7 dry 7-9 wet	-	-	640	800
A	3,000	0.488	0.532	0.550	0.594	3.5	4	564	-	602	-
B	2,500	0.488	0.567	0.559	0.630	2.5	4	508	-	545	-
B Slip Formed	2,500	0.488	0.567	-	-	1.5	-	508	-	-	-
Sand Light- weight	4,500	-	0.420	-	-	4	-	715	-	-	-
Latex Modified	3,000 7 day	0.400	0.400	-	-	6	-	658	-	-	-
Flowable Fill excavatable	150 max. at 56 days	as needed	as needed	as needed	as needed	-	Flow- able	-	-	40	100
Flowable Fill non-excavatable	125	as needed	as needed	as needed	as needed	-	Flow- able	-	-	100	as needed
Pavement	4,500 design, field 650 flexural, design only	0.559	0.559	-	-	1.5 slip form 3.0 hand place	-	526	-	-	-
Precast	See Table 1077-1	as needed	as needed	-	-	6	as needed	as needed	as needed	as needed	as needed
Prestress	per contract	See Table 1078-1	See Table 1078-1	-	-	8	-	564	as needed	-	-

****NOTE ** Relocated Page 10-65, Article 1050-1, General, Line 41 revisions**

Page 10-23, Table 1005-1, AGGREGATE GRADATION-COARSE AGGREGATE, replace with the following:

Std. Size #	Percentage of Total by Weight Passing														Remarks
	2"	1 1/2"	1"	3/4"	1/2"	3/8"	#4	#8	#10	#16	#40	#200			
4	100	90-100	20-55	0-15	-	0-5	-	-	-	-	-	A	Asphalt Plant Mix		
467M	100	95-100	-	35-70	-	0-30	0-5	-	-	-	-	A	Asphalt Plant Mix		
5	-	100	90-100	20-55	0-10	0-5	-	-	-	-	-	A	AST, Sediment Control Stone		
57	-	100	95-100	-	25-60	-	0-10	0-5	-	-	-	A	AST, Str. Concrete, Shoulder Drain, Sediment Control Stone		
57M	-	100	95-100	-	25-45	-	0-10	0-5	-	-	-	A	AST, Concrete Pavement		
6M	-	-	100	90-100	20-55	0-20	0-8	-	-	-	-	A	AST		
67	-	-	100	90-100	-	20-55	0-10	0-5	-	-	-	A	AST, Str. Concrete, Asphalt Plant Mix		
78M	-	-	-	100	98-100	75-100	20-45	0-15	-	-	-	A	Asphalt Plant Mix, Str. Conc, Weep Hole Drains		
14M	-	-	-	-	-	100	35-70	5-20	-	0-8	-	A	Asphalt Plant Mix, AST, Weep Hole Drains, Str. Concrete		
9	-	-	-	-	-	100	85-100	10-40	-	0-10	-	A	AST		
ABC	-	100	75-97	-	55-80	-	35-55	-	25-45	-	14-30	4-12 ^B	Aggregate Base Course, Aggregate Stabilization		
ABC (M)	-	100	75-100	-	45-79	-	20-40	-	0-25	-	-	0-12 ^B	Maintenance Stabilization		
Light-C weight	-	-	-	-	100	80-100	5-40	0-20	-	0-10	-	0-2.5	AST		

- A. See Subarticle 1005-4(A).
- B. See Subarticle 1005-4(B).
- C. For Lightweight Aggregate used in Structural Concrete, see Subarticle 1014-2(E)(6).

Page 10-46, Article 1024-1, PORTLAND CEMENT, Line 33, add the following as the ninth paragraph:

Use Type IL blended cement that meets AASHTO M 240, except that the limestone content is limited to between 5 and 12% by weight and the constituents shall be interground. Class F fly ash can replace a portion of Type IL blended cement and shall be replaced as outlined in

Subarticle 1000-4(I) for Portland cement. For mixes that contain cement with alkali content between 0.6% and 1.0% and for mixes that contain a reactive aggregate documented by the Department, use a pozzolan in the amount shown in Table 1024-1.

Page 10-65, Article 1050-1, GENERAL, Line 41, replace the first sentence with the following:

All fencing material and accessories shall meet Section 106.

Page 10-73, Article 1056-1 DESCRIPTION, Lines 7-8, delete the first sentence of the second paragraph and replace with the following:

Use geotextile fabrics that are on the NCDOT Approved Products List.

Page 10-73, Article 1056-2 HANDLING AND STORING, Line 17, replace “mechanically stabilized earth (MSE) wall faces” with “temporary wall faces”.

Page 10-74, TABLE 1056-1 GEOTEXTILE REQUIREMENTS, replace table with the following:

TABLE 1056-1 GEOTEXTILE REQUIREMENTS						
Property	Requirement (MARV^A)					Test Method
	Type 1	Type 2	Type 3^B	Type 4	Type 5^C	
<i>Typical Application</i>	<i>Shoulder Drains</i>	<i>Under Rip Rap</i>	<i>Temporary Silt Fence</i>	<i>Soil Stabilization</i>	<i>Temporary Walls</i>	
Elongation (MD & CD)	≥ 50%	≥ 50%	≤ 25%	< 50%	< 50%	ASTM D4632
Grab Strength (MD & CD)			100 lb		-	ASTM D4632
Tear Strength (MD & CD)	Table 1 ^D , Class 3	Table 1 ^D , Class 1	-	Table 1 ^D , Class 3	-	ASTM D4533
Puncture Strength			-		-	ASTM D6241
Ultimate Tensile Strength (MD & CD)	-	-	-	-	2,400 lb/ft (unless required otherwise in the contract)	ASTM D4595
Permittivity	Table 2 ^D , 15% to 50% <i>in Situ</i> Soil Passing No. 200 ^E		Table 7 ^D	Table 5 ^D	0.20 sec ⁻¹	ASTM D4491
Apparent Opening Size					No. 30 ^E	ASTM D4751
UV Stability (Retained Strength)					70%	ASTM D4355

- A. MARV does not apply to elongation
- B. Minimum roll width of 36" required
- C. Minimum roll width of 13 feet required
- D. AASHTO M 288
- E. US Sieve No. per AASHTO M 92

Page 10-115, Subarticle 1074-7(B), Gray Iron Castings, Lines 10-11, replace with the first two sentences with the following:

Supply gray iron castings meeting all facets of AASHTO M 306 excluding proof load. Proof load testing will only be required for new casting designs during the design process, and conformance to M306 loading (40,000 lbs.) will be required only when noted on the design documents

Page 10-126, Table 1078-1, REQUIREMENTS FOR CONCRETE, replace with the following:

TABLE 1078-1 REQUIREMENTS FOR CONCRETE		
Property	28 Day Design Compressive Strength 6,000 psi or less	28 Day Design Compressive Strength greater than 6,000 psi
Maximum Water/Cementitious Material Ratio	0.45	0.40
Maximum Slump without HRWR	3.5"	3.5"
Maximum Slump with HRWR	8"	8"
Air Content (upon discharge into forms)	5 + 2%	5 + 2%

Page 10-151, Article 1080-4 Inspection and Sampling, Lines 18-22, replace (B), (C) and (D) with the following:

- (B) At least 3 panels prepared as specified in 5.5.10 of AASHTO M 300, Bullet Hole Immersion Test.
- (C) At least 3 panels of 4"x6"x1/4" for the Elcometer Adhesion Pull Off Test, ASTM D4541.
- (D) A certified test report from an approved independent testing laboratory for the Salt Fog Resistance Test, Cyclic Weathering Resistance Test, and Bullet Hole Immersion Test as specified in AASHTO M 300.
- (E) A certified test report from an approved independent testing laboratory that the product has been tested for slip coefficient and meets AASHTO M253, Class B.

Page 10-161, Subarticle 1081-1(A) Classifications, Lines 29-33, delete first 3 sentences of the description for Type 2 and replace with the following:

Type 2 - A low-modulus, general-purpose adhesive used in epoxy mortar repairs. It may be used to patch spalled, cracked or broken concrete where vibration, shock or expansion and contraction are expected.

Page 10-162, Subarticle 1081-1(A) Classifications, Lines 4-7, delete the second and third sentences of the description for Type 3A. **Lines 16-22,** delete Types 6A, 6B, and 6C.

Page 10-162, Subarticle 1081-1(B) Requirements, Lines 26-30, replace the second paragraph with the following:

For epoxy resin systems used for embedding dowel bars, threaded rods, rebar, anchor bolts and other fixtures in hardened concrete, the manufacturer shall submit test results showing that the bonding system will obtain 125% of the specified required yield strength of the fixture. Furnish certification that, for the particular bolt grade, diameter and embedment depth required, the anchor system will not fail by adhesive failure and that there is no movement of the anchor bolt. For certification and anchorage, use 3,000 psi as the minimum Portland cement concrete compressive strength used in this test. Use adhesives that meet Section 1081.

List the properties of the adhesive on the container and include density, minimum and maximum temperature application, setting time, shelf life, pot life, shear strength and compressive strength.

Page 10-163, Table 1081-1 Properties of Mixed Epoxy Resin Systems, replace table with the following:

Table 1081-1 Properties of Mixed Epoxy Resin Systems							
Property	Type 1	Type 2	Type 3	Type 3A	Type 4A	Type 4B	Type 5
Viscosity-Poises at 77°F ± 2°F	Gel	10-30	25-75	Gel	40-150	40-150	1-6
Spindle No.	-	3	4	--	4	4	2
Speed (RPM)	-	20	20	--	10	10	50
Pot Life (Minutes)	20-50	30-60	20-50	5-50	40-80	40-80	20-60
Minimum Tensile Strength at 7 days (psi)	1,500	2,000	4,000	4,000	1,500	1,500	4,000
Tensile Elongation at 7 days (%)	30 min.	30 min.	2-5	2-5	5-15	5-15	2-5
Min. Compressive Strength of 2" mortar cubes at 24 hours	3,000 (Neat)	4,000-	6,000-	6,000 (Neat)	3,000	3,000	6,000
Min. Compressive Strength of 2" mortar cubes at 7 days	5,000 (Neat)	-	-	-	-	5,000	-
Maximum Water Absorption (%)	1.5	1.0	1.0	1.5	1.0	1.0	1.0
Min. Bond Strength Slant Shear Test at 14 days (psi)	1,500	1,500	2,000	2,000	1,500	1,500	1,500

Page 10-164, Subarticle 1081-1(E) Prequalification, Lines 31-33, replace the second sentence of the first paragraph with the following:

Manufacturers choosing to supply material for Department jobs must submit an application through the Value Management Unit with the following information for each type and brand name:

Page 10-164, Subarticle 1081-1(E)(3), Line 37, replace this subarticle with the following:

- (3) Type of the material in accordance with Articles 1081-1 and 1081-4,

Page 10-165, Subarticle 1081-1(E)(6), Line 1, in the first sentence of the first paragraph replace “AASHTO M 237” with “the specifications”.

Page 10-165, Subarticle 1081-1(E) Prequalification, Line 9-10, delete the second sentence of the last paragraph.

Page 10-165, Subarticle 1081-1(F) Acceptance, Line 14, in the first sentence of the first paragraph replace “Type 1” with “Type 3”.

Page 10-169, Subarticle 1081-3(G) Anchor Bolt Adhesives, delete this subarticle.

Page 10-170, Article 1081-3 Hot Bitumen, Line 9, add the following at the end of Section 1081:

1081-4 EPOXY RESIN ADHESIVE FOR BONDING TRAFFIC MARKINGS

(A) General

This section covers epoxy resin adhesive for bonding traffic markers to pavement surfaces.

(B) Classification

The types of epoxies and their uses are as shown below:

Type I – Rapid Setting, High Viscosity, Epoxy Adhesive. This type of adhesive provides rapid adherence to traffic markers to the surface of pavement.

Type II – Standard Setting, High Viscosity, Epoxy Adhesive. This type of adhesive is recommended for adherence of traffic markers to pavement surfaces when rapid set is not required.

Type III – Rapid Setting, Low Viscosity, Water Resistant, Epoxy Adhesive. This type of rapid setting adhesive, due to its low viscosity, is appropriate only for use with embedded traffic markers.

Type IV – Standard Set Epoxy for Blade Deflecting-Type Plowable Markers.

(C) Requirements

Epoxies shall conform to the requirements set forth in AASHTO M 237.

(D) Prequalification

Refer to Subarticle 1081-1(E).

(E) Acceptance

Refer to Subarticle 1081-1(F).

Page 10-173, Article 1084-2 STEEL SHEET PILES, Lines 37-38, replace first paragraph with the following:

Steel sheet piles detailed for permanent applications shall be hot rolled and meet ASTM A572 or ASTM A690 unless otherwise required by the plans developed by the Design-Build Team. Steel sheet piles shall be coated as required by the plans developed by the Design-Build Team. Galvanized sheet piles shall be coated in accordance with Section 1076. Metallized sheet piles shall be metallized in accordance to the Project Special Provision “Thermal Sprayed Coatings (Metallization)” with an 8 mil, 99.9% aluminum alloy coating and a 0.5 mil seal coating. Any portion of the metallized sheet piling encased in concrete shall receive a barrier coat. The barrier coat shall be an approved waterborne coating with a low-viscosity which readily absorbs into the pores of the aluminum thermal sprayed coating. The waterborne coating shall be applied at a spreading rate that results in a theoretical 1.5 mil dry film thickness. The manufacturer shall issue a letter of certification that the resin chemistry of the waterborne coating is compatible with the 99.9% aluminum thermal sprayed alloy and suitable for tidal water applications.

Page 10-174, Subarticle 1086-1(B)(1) Epoxy, Lines 18-24, replace this subarticle with the following:

The epoxy shall meet Article 1081-4.

The 2 types of epoxy adhesive which may be used are Type I, Rapid Setting, and Type II, Standard Setting. Use Type II when the pavement temperature is above 60°F or per the manufacturer’s recommendations whichever is more stringent. Use Type I when the pavement temperature is between 50°F and 60°F or per the manufacturer’s recommendations whichever is more stringent. Epoxy adhesive Type I, Cold Set, may be used to attach temporary pavement markers to the pavement surface when the pavement temperature is between 32°F and 50°F or per the manufacturer’s recommendations whichever is more stringent.

Page 10-175, Subarticle 1086-2(E) Epoxy Adhesives, Line 27, replace “Section 1081” with “Article 1081-4”.

Page 10-177, Subarticle 1086-3(E) Epoxy Adhesives, Line 22, replace “Section 1081” with “Article 1081-4”.

Page 10-179, Subarticle 1087-4(A) Composition, Lines 39-41, replace the third paragraph with the following:

All intermixed and drop-on glass beads shall not contain more than 75 ppm arsenic or 200 ppm lead.

Page 10-180, Subarticle 1087-4(B) Physical Characteristics, Line 8, replace the second paragraph with the following:

All intermixed and drop-on glass beads shall comply with NCGS § 136-30.2 and 23 USC § 109(r).

Page 10-181, Subarticle 1087-7(A) Intermixed and Drop-on Glass Beads, Line 24, add the following after the first paragraph:

Use X-ray Fluorescence for the normal sampling procedure for intermixed and drop-on beads, without crushing, to check for any levels of arsenic and lead. If any arsenic or lead is detected, the sample shall be crushed and repeat the test using X-ray Fluorescence. If the X-ray Fluorescence test shows more than a LOD of 5 ppm, test the beads using United States Environmental Protection Agency Method 6010B, 6010C or 3052 for no more than 75 ppm arsenic or 200 ppm lead.

Page 10-204, Subarticle 1092-2(A) Performance and Test Requirements, replace **Table 1092-3 Minimum Coefficient of Retroreflection for NC Grade A** with the following:

Observation Angle, degrees	Entrance Angle, degrees	White	Yellow	Green	Red	Blue	Fluorescent Yellow Green	Fluorescent Yellow
0.2	-4.0	525	395	52	95	30	420	315
0.2	30.0	215	162	22	43	10	170	130
0.5	-4.0	310	230	31	56	18	245	185
0.5	30.0	135	100	14	27	6	110	81
1.0	-4.0	120	60	8	16	3.6	64	48
1.0	30.0	45	34	4.5	9	2	36	27

SELECT MATERIAL, CLASS III, TYPE 3

12-02-11

DB10 R005

Revise the 2012 *Standard Specifications for Roads and Structures* as follows:

Page 10-39, Article 1016-3, CLASS III, add the following after line 14:

Type 3 Select Material

Type 3 select material is a natural or manufactured fine aggregate material meeting the following gradation requirements and as described in Sections 1005 and 1006:

Percentage of Total by Weight Passing							
3/8"	#4	#8	#16	#30	#50	#100	#200
100	95-100	65-100	35-95	15-75	5-35	0-25	0-8

Page 10-39, Article 1016-3, CLASS III, Line 15, replace “either type” with “Type 1, Type 2 or Type 3”.

Page 10-62, Article 1044-1, Line 36, delete the sentence and replace with the following:

Subdrain fine aggregate shall meet Class III select material, Type 1 or Type 3.

Page 10-63, Article 1044-2, Line 2, delete the sentence and replace with the following:

Subdrain coarse aggregate shall meet Class V select material.

SHOULDER AND SLOPE BORROW

1/22/13

1019

DB10 R10

Use soil in accordance with Section 1019 of the 2012 *Standard Specifications for Roads and Structures*. Use soil consisting of loose, friable, sandy material with a PI greater than 6 and less than 25 and a pH ranging from 5.5 to 7.0.

Soil with a pH ranging from 4.0 to 5.5 will be accepted without further testing if additional limestone is provided in accordance with the application rates shown in Table 1019-1A. Soil type is identified during the soil analysis. Soils with a pH above 7.0 require acidic amendments to be added. Submit proposed acidic amendments to the Engineer for review and approval. Soils with a pH below 4.0 or that do not meet the PI requirements shall not be used.

TABLE 1019-1A			
ADDITIONAL LIMESTONE APPLICATION RATE TO RAISE pH			
pH TEST RESULT	Sandy Soils Additional Rate (lbs. / Acre)	Silt Loam Soils Additional Rate (lbs. / Acre)	Clay Loam Soils Additional Rate (lbs. / Acre)
4.0 - 4.4	1,000	4,000	6,000
4.5 - 4.9	500	3,000	5,000
5.0 - 5.4	NA	2,000	4,000

Note: Limestone application rates shown in this table are in addition to the standard rate of 4000 lbs. / acre required for seeding and mulching.

No direct payment will be made for providing additional lime or acidic amendments for Ph adjustment.

TEMPORARY SHORING

(3/26/13)

DB11 R02

Description

Temporary shoring includes cantilever, braced and anchored shoring and temporary mechanically stabilized earth (MSE) walls. Temporary shoring does not include trench boxes. At the Design-Build Team’s option, use any type of temporary shoring. In addition, the Design-Build Team may elect to consider the use of standard shoring where appropriate. In such case, the Standard Shoring Project Special Provision, standard shoring selection forms, and Standard Temporary Shoring Drawings No. 1801.01 and/or 1801.02 will apply. The Standard Shoring provision can be found at:

https://connect.ncdot.gov/resources/Geological/Pages/Geotech_Provisions_Notes.aspx

and the standard shoring selection forms and aforementioned drawings may be found at:

https://connect.ncdot.gov/resources/Geological/Pages/Geotech_Forms_Details.aspx

Design and construct temporary shoring based on actual elevations and shoring dimensions in accordance with the contract and accepted submittals. Construct temporary shoring at locations shown in the plans developed by the Design-Build Team. Temporary shoring is required to maintain traffic when a 2:1 (H:V) slope from the top of an embankment or bottom of an excavation will intersect the existing ground line less than 5 feet from the edge of pavement of an open travelway. This provision does not apply to pipe, inlet or utility installation unless noted otherwise in the plans developed by the Design-Build Team.

Positive protection includes concrete barrier and temporary guardrail. Provide positive protection for temporary shoring at locations shown in the plans developed by the Design-Build Team and as directed. Positive protection is required if temporary shoring is located in the clear zone in accordance with the *AASHTO Roadside Design Guide*.

(A) Cantilever and Braced Shoring

Cantilever shoring consists of steel sheet piles or H-piles with timber lagging. Braced shoring consists of sheet piles or H-piles with timber lagging and bracing such as beams, plates, walers, struts, rakers, etc. Define “piles” as sheet piles or H-piles.

(B) Anchored Shoring

Anchored shoring consists of sheet piles with walers or H-piles with timber lagging anchored with ground or helical anchors. Driven anchors may be accepted at the discretion of the Engineer. A ground anchor consists of a grouted steel bar or multi-strand tendon with an anchorage. A helical anchor consists of a lead section with a central steel shaft and at least one helix steel plate followed by extensions with only central shafts (no helixes) and an anchorage. Anchorages consist of steel bearing plates with washers and hex nuts for bars or steel wedge plates and wedges for strands. Use a prequalified Anchored Wall Contractor to install ground anchors. Define “anchors” as ground, helical or driven anchors.

(C) Temporary MSE Walls

Temporary MSE walls include temporary geosynthetic and wire walls. Define “temporary wall” as a temporary MSE wall. Define “reinforcement” as geotextile, geogrid, welded wire grid or metallic strip reinforcement.

Temporary geosynthetic walls consist of geotextile or geogrid reinforcement wrapped behind welded wire facing. Define “temporary geotextile wall” as a temporary geosynthetic wall with geotextile reinforcement and “temporary geogrid wall” as a temporary geosynthetic wall with geogrid reinforcement.

Temporary wire walls consist of welded wire grid or metallic strip reinforcement connected to welded wire facing. Define “Wire Wall Vendor” as the vendor supplying the temporary wire wall.

(D) Embedment

Define “embedment” for cantilever, braced and anchored shoring as the pile depth below the grade in front of shoring. Define “embedment” for temporary walls as the wall height below the grade in front of walls.

(E) Positive Protection

Define “unanchored or anchored portable concrete barrier” as portable concrete barrier (PCB) that meets *Roadway Standard Drawings* No. 1170.01. Define “concrete barrier” as unanchored or anchored PCB or an approved equal. Define “temporary guardrail” as temporary steel beam guardrail that meets *Roadway Standard Drawings* No. 862.02.

Materials

Refer to the 2012 *Standard Specifications for Roads and Structures*.

Item	Section
Anchor Pins	1056-2
Concrete Barrier Materials	1170-2
Flowable Fill, Excavatable	1000-6
Geotextiles	1056
Neat Cement Grout	1003
Portland Cement Concrete	1000
Select Material	1016
Steel Plates	1072-2
Steel Beam Guardrail Materials	862-2
Steel Sheet Piles and H-Piles	1084
Untreated Timber	1082-2
Welded Wire Reinforcement	1070-3
Wire Staples	1060-8(D)

Provide Type 6 material certifications for shoring material in accordance with Article 106-3 of the 2012 *Standard Specifications*. Use Class IV select material (standard size No. ABC) for temporary guardrail. Use nonshrink neat cement grout or Class A concrete that meets Article 450-2 of the 2012 *Standard Specifications for Roads and Structures* for drilled-in H-piles. Provide concrete with a slump of 6" to 8". Use an approved high-range water reducer to achieve this slump. Use untreated timber with a thickness of at least 3" and a bending stress of at least 1,000 psi for timber lagging. Provide steel bracing that meets ASTM A36.

(A) Shoring Backfill

Use Class II, Type 1, Class III, Class V or Class VI select material or material that meets AASHTO M 145 for soil classification A-2-4 with a maximum PI of 6 for shoring backfill except do not use A-2-4 soil for backfill around culverts.

(B) Anchors

Store anchor materials on blocking a minimum of 12" above the ground and protect it at all times from damage; and when placing in the work make sure it is free from dirt, dust, loose mill scale, loose rust, paint, oil or other foreign materials. Load, transport, unload and store anchor materials such that they are kept clean and free of damage. Bent, damaged or defective materials will be rejected.

(1) Ground Anchors

Use high-strength steel bars that meet AASHTO M 275 or seven-wire strands that meet ASTM A886 or Article 1070-5 of the 2012 *Standard Specifications for Roads and Structures*. Splice bars in accordance with Article 1070-9 of the 2012 *Standard Specifications for Roads and Structures*. Do not splice strands.

Provide bondbreakers, spacers and centralizers that meet Article 6.3.5 of the *AASHTO LRFD Bridge Construction Specifications*.

(2) Helical Anchors

Use helical anchors with an ICC Evaluation Service, Inc. (ICC-ES) report. Helical anchors without an ICC-ES report may be approved at the discretion of the Engineer. Provide couplers, thread bar adapters and bolts recommended by the Anchor Manufacturer to connect helical anchors together and to piles.

(3) Anchorages

Provide steel plates for bearing plates and steel washers, hex nuts, wedge plates and wedges recommended by the Anchor Manufacturer.

(C) **Temporary Walls**

(1) Welded Wire Facing

Use welded wire reinforcement for welded wire facing, struts and wires. For temporary wire walls, provide welded wire facing supplied by the Wire Wall Vendor or a manufacturer approved or licensed by the vendor. For temporary wire walls with separate reinforcement and facing components, provide connectors (e.g., bars, clamps, plates, etc.) and fasteners (e.g., bolts, nuts, washers, etc.) required by the Wire Wall Vendor.

(2) Geotextiles

Provide Type 2 geotextile for separation and retention geotextiles. Provide Type 5 geotextile for geotextile reinforcement with ultimate tensile strengths in accordance with the accepted submittals.

(3) Geogrid Reinforcement

Handle and store geogrids in accordance with Article 1056-2 of the 2012 *Standard Specifications for Roads and Structures*. Define “machine direction” (MD) and “cross-machine direction” (CD) for geogrids in accordance with ASTM D4439.

Use geogrids with a roll width of at least 4 feet and an “approved” or “approved for provisional use” status code. The list of approved geogrids is available from:

connect.ncdot.gov/resources/Materials/Pages/SoilsLaboratory.aspx

Provide geogrids for geogrid reinforcement with design strengths in accordance with the accepted submittals. Geogrids are typically approved for ultimate tensile strengths in the MD and CD or short-term design strengths for a 3-year design life in the MD based on material type. Define material type from the website above for shoring backfill as follows:

Material Type	Shoring Backfill
Borrow	A-2-4 Soil
Fine Aggregate	Class II, Type 1 or Class III Select Material
Coarse Aggregate	Class V or VI Select Material

(4) **Welded Wire Grid and Metallic Strip Reinforcement**

Provide welded wire grid and metallic strip reinforcement supplied by the Wire Wall Vendor or a manufacturer approved or licensed by the vendor. Use welded wire grid reinforcement (“mesh”, “mats” and “ladders”) that meet Article 1070-3 of the 2012 *Standard Specifications for Roads and Structures* and metallic strip reinforcement (“straps”) that meet ASTM A572 or A1011.

Preconstruction Requirements

(A) Concrete Barrier

Define “clear distance” behind concrete barrier as the horizontal distance between the barrier and edge of pavement. The minimum required clear distance for concrete barrier is shown in the plans developed by the Design-Build Team. At the Design-Build Team’s option or if the minimum required clear distance is not available, set concrete barrier next to and up against traffic side of temporary shoring except for barrier above temporary walls. Concrete barrier with the minimum required clear distance is required above temporary walls.

(B) Temporary Guardrail

Define “clear distance” behind temporary guardrail as the horizontal distance between guardrail posts and temporary shoring. At the Design-Build Team’s option or if clear distance for cantilever, braced and anchored shoring is less than 4 ft., attach guardrail to traffic side of shoring as shown in the plans developed by the Design-Build Team. Place ABC in clear distance and around guardrail posts instead of pavement. Do not use temporary guardrail above temporary walls.

(C) Temporary Shoring Designs

Before beginning temporary shoring design, survey existing ground elevations in the vicinity of shoring locations to determine actual design heights (H). Submit 8 copies of working drawings and 3 copies of design calculations and a PDF copy of each for temporary shoring designs in accordance with Article 105-2 of the 2012 *Standard Specifications for Roads and Structures*. Submit working drawings showing plan views, shoring profiles, typical sections and details of temporary shoring design and construction sequence. Do not begin shoring construction until a design submittal is accepted.

Have cantilever and braced shoring designed, detailed and sealed by an engineer licensed in the state of North Carolina. Use a prequalified Anchored Wall Design Consultant to

design anchored shoring. Provide anchored shoring designs sealed by a Design Engineer approved as a Geotechnical Engineer (key person) for an Anchored Wall Design Consultant. Include details in anchored shoring working drawings of anchor locations and lock-off loads, unit grout/ground bond strengths for ground anchors or minimum installation torque and torsional strength rating for helical anchors and if necessary, obstructions extending through shoring or interfering with anchors. Include details in the anchored shoring construction sequence of pile and anchor installation, excavation and anchor testing.

Use a prequalified MSE Wall Design Consultant to design temporary walls. Provide temporary wall designs sealed by a Design Engineer approved as a Geotechnical Engineer (key person) for the MSE Wall Design Consultant. Include details in temporary wall working drawings of geotextile and reinforcement types, locations and directions and obstructions extending through walls or interfering with reinforcement.

(1) Soil Parameters

Design temporary shoring for the assumed soil parameters and groundwater elevations shown in the plans developed by the Design-Build Team. Assume the following soil parameters for shoring backfill:

(a) Unit weight (γ) = 120 lb/cf;

(b)

Friction Angle (ϕ)	Shoring Backfill
30°	A-2-4 Soil
34°	Class II, Type 1 or Class III Select Material
38°	Class V or VI Select Material

(c) Cohesion (c) = 0 lb/sf.

(2) Traffic Surcharge

Design temporary shoring for a traffic surcharge of 250 lb/sf if traffic will be above and within H of shoring. This traffic surcharge does not apply to construction traffic. Design temporary shoring for any construction surcharge if construction traffic will be above and within H of shoring. For LRFD shoring designs, apply traffic (live load) surcharge in accordance with Figure C11.5.5-3 of the *AASHTO LRFD Bridge Design Specifications*.

(3) Cantilever, Braced and Anchored Shoring Designs

Use shoring backfill for fill sections and voids between cantilever, braced and anchored shoring and the critical failure surface. Use grout or concrete for embedded portions of drilled-in H-piles. Do not use drilled-in sheet piles.

Define “top of shoring” for cantilever, braced and anchored shoring as where the grade intersects the back of sheet piles or H-piles and timber lagging. Design cantilever, braced and anchored shoring for a traffic impact load of 2,000 lb/ft

applied 18" above top of shoring if concrete barrier is above and next to shoring or temporary guardrail is above and attached to shoring. For anchored shoring designs, apply traffic impact load as horizontal load (P_{HI}) in accordance with Figure 3.11.6.3-2(a) of the AASHTO LRFD specifications.

Extend cantilever, braced and anchored shoring at least 32" above top of shoring if shoring is designed for traffic impact. Otherwise, extend shoring at least 6" above top of shoring.

Design cantilever, braced and anchored shoring for a maximum deflection of 3" if the horizontal distance to the closest edge of pavement or structure is less than H. Otherwise, design shoring for a maximum deflection of 6". Design cantilever and braced shoring in accordance with the plans developed by the Design-Build Team and *AASHTO Guide Design Specifications for Bridge Temporary Works*.

Design anchored shoring in accordance with the plans developed by the Design-Build Team and Article 11.9 of the *AASHTO LRFD Bridge Design Specifications*. Use a resistance factor of 0.80 for tensile resistance of anchors with bars, strands or shafts. Extend the unbonded length for ground anchors and the shallowest helix for helical anchors at least 5 feet behind the critical failure surface. Do not extend anchors beyond right-of-way or easement limits. If existing or future obstructions such as foundations, guardrail posts, pavements, pipes, inlets or utilities will interfere with anchors, maintain a clearance of at least 6" between obstructions and anchors.

(4) Temporary Wall Designs

Use shoring backfill in the reinforced zone of temporary walls. Separation geotextiles are required between shoring backfill and backfill, natural ground or culverts along the sides of the reinforced zone perpendicular to the wall face. For Class V or VI select material in the reinforced zone, separation geotextiles are also required between shoring backfill and backfill or natural ground on top of and at the back of the reinforced zone.

Design temporary walls in accordance with the plans developed by the Design-Build Team and Article 11.10 of the *AASHTO LRFD Bridge Design Specifications*. Embed temporary walls at least 18" except for walls on structures or rock as determined by the Engineer. Use a uniform reinforcement length throughout the wall height of at least 0.7H or 6 feet, whichever is greater. Extend the reinforced zone at least 6" beyond end of reinforcement. Do not locate the reinforced zone outside right-of-way or easement limits.

Use the simplified method for determining maximum reinforcement loads in accordance with the AASHTO LRFD specifications. For geotextile reinforcement, use geotextile properties approved by the Department or default values in accordance with the AASHTO LRFD specifications. For geogrid reinforcement, use approved geogrid properties available from the website shown elsewhere in this provision. If the website does not list a short-term

design strength for an approved geogrid, use a short-term design strength equal to the ultimate tensile strength divided by 3.5 for the geogrid reinforcement. Use geosynthetic properties for the direction reinforcement will be installed, a 3-year design life and shoring backfill to be used in the reinforced zone.

Do not use more than 4 different reinforcement strengths for each temporary geosynthetic wall. Design temporary geotextile walls for a reinforcement coverage ratio (R_c) of 1.0 and temporary geogrid walls for an R_c of at least 0.8. For geogrid reinforcement with an R_c of less than 1.0, use a maximum horizontal clearance between geogrids of 3 feet and stagger reinforcement so geogrids are centered over gaps in the reinforcement layer below.

For temporary geosynthetic walls, use "L" shaped welded wire facing with 18" to 24" long legs. Locate geotextile or geogrid reinforcement so reinforcement layers are at the same level as the horizontal legs of welded wire facing. Use vertical reinforcement spacing equal to facing height. Wrap geotextile or geogrid reinforcement behind welded wire facing and extend reinforcement at least 3 feet back behind facing into shoring backfill.

For temporary wire walls with separate reinforcement and facing components, attach welded wire grid or metallic strip reinforcement to welded wire facing with a connection approved by the Department. For temporary geogrid and wire walls, retain shoring backfill at welded wire facing with retention geotextiles and extend geotextiles at least 3 feet back behind facing into backfill.

(D) Preconstruction Meeting

The Engineer may require a shoring preconstruction meeting to discuss the construction, inspection and testing of the temporary shoring. If required, schedule this meeting after all shoring submittals have been accepted. The Resident, District or Bridge Maintenance Engineer, Bridge or Roadway Construction Engineer, Geotechnical Operations Engineer, Contractor and Shoring Contractor Superintendent will attend this preconstruction meeting.

Construction Methods

Control drainage during construction in the vicinity of shoring. Direct run off away from shoring and shoring backfill. Contain and maintain backfill and protect material from erosion.

Install positive protection in accordance with the contract and accepted submittals. Use PCB in accordance with Section 1170 of the 2012 *Standard Specifications for Roads and Structures* and Standard Drawing No. 1170.01. Use temporary guardrail in accordance with Section 862 of the 2012 *Standard Specifications for Roads and Structures* and Standard Drawing No. 862.01, 862.02 and 862.03.

(A) Tolerances

Construct shoring with the following tolerances:

- (1) Horizontal wires of welded wire facing are level in all directions,
- (2) Shoring location is within 6" of horizontal and vertical alignment shown in the accepted submittals, and
- (3) Shoring plumbness (batter) is not negative and within 2° of vertical.

(B) Cantilever, Braced and Anchored Shoring Installation

If overexcavation behind cantilever, braced or anchored shoring is shown in the accepted submittals, excavate before installing piles. Otherwise, install piles before excavating for shoring. Install cantilever, braced or anchored shoring in accordance with the construction sequence shown in the accepted submittals. Remove piles and if applicable, timber lagging when shoring is no longer needed.

(1) Pile Installation

Install piles with the minimum required embedment and extension in accordance with Subarticles 450-3(D) and 450-3(E) of the 2012 *Standard Specifications for Roads and Structures* except that a pile driving equipment data form is not required. Piles may be installed with a vibratory hammer as approved by the Engineer.

Do not splice sheet piles. Use pile excavation to install drilled-in H-piles. After filling holes with grout or concrete to the elevations shown in the accepted submittals, remove any fluids and fill remaining portions of holes with flowable fill. Cure grout or concrete at least 7 days before excavating.

Notify the Engineer if refusal is reached before pile excavation or driven piles attain the minimum required embedment. When this occurs, a revised design submittal may be required.

(2) Excavation

Excavate in front of piles from the top down in accordance with the accepted submittals. For H-piles with timber lagging and braced and anchored shoring, excavate in staged horizontal lifts with a maximum height of 5 ft. Remove flowable fill and material in between H-piles as needed to install timber lagging. Position lagging with at least 3" of contact in the horizontal direction between the lagging and pile flanges. Do not excavate the next lift until timber lagging for the current lift is installed and if applicable, bracing and anchors for the current lift are accepted. Backfill behind cantilever, braced or anchored shoring with shoring backfill.

(3) Anchor Installation

If applicable, install foundations located behind anchored shoring before installing anchors. Fabricate and install ground anchors in accordance with the accepted submittals, Articles 6.4 and 6.5 of the *AASHTO LRFD Bridge Construction Specifications* and the following unless otherwise approved:

- (a) Materials in accordance with this provision are required instead of materials conforming to Articles 6.4 and 6.5.3 of the AASHTO LRFD Specifications,
- (b) Encapsulation-protected ground anchors in accordance with Article 6.4.1.2 of the AASHTO LRFD specifications are not required, and
- (c) Corrosion protection for unbonded lengths of ground anchors and anchorage covers are not required.

Install helical anchors in accordance with the accepted submittals and Anchor Manufacturer's instructions. Measure torque during installation and do not exceed the torsional strength rating of the helical anchor. Attain the minimum required installation torque and penetration before terminating anchor installation. When replacing a helical anchor, embed last helix of the replacement anchor at least 3 helix plate diameters past the location of the first helix of the previous anchor.

(4) Anchor Testing

Proof test and lock-off anchors in accordance with the accepted submittals and Article 6.5.5 of the *AASHTO LRFD Bridge Construction Specifications* except for the acceptance criteria in Article 6.5.5.5. For the AASHTO LRFD specifications, "ground anchor" refers to a ground or helical anchor and "tendon" refers to a bar, strand or shaft.

(a) Anchor Acceptance

Anchor acceptance is based in part on the following criteria.

- (i) For ground and helical anchors, total movement is less than 0.04" between the 1 and 10 minute readings or less than 0.08" between the 6 and 60 minute readings.
- (ii) For ground anchors, total movement at maximum test load exceeds 80% of the theoretical elastic elongation of the unbonded length.

(b) Anchor Test Results

Submit 2 copies of anchor test records including movement versus load plots for each load increment within 24 hours of completing each row of

anchors. The Engineer will review the test records to determine if the anchors are acceptable.

If the Engineer determines an anchor is unacceptable, revise the anchor design or installation methods. Submit a revised anchored shoring design for acceptance and provide an acceptable anchor with the revised design or installation methods. If required, replace the anchor or provide additional anchors with the revised design or installation methods.

(C) Temporary Wall Installation

Excavate as necessary for temporary walls in accordance with the plans developed by the Design-Build Team and accepted submittals. If applicable, install foundations located in the reinforced zone before placing shoring backfill or reinforcement unless otherwise approved. Notify the Engineer when foundation excavation is complete. Do not place shoring backfill or reinforcement until excavation dimensions and foundation material are approved.

Erect welded wire facing so the wall position is as shown in the plans developed by the Design-Build Team and accepted submittals. Set welded wire facing adjacent to each other in the horizontal and vertical direction to completely cover the wall face with facing. Stagger welded wire facing to create a running bond by centering facing over joints in the row below.

Wrap geotextile reinforcement and retention geotextiles behind welded wire facing as shown in the plans developed by the Design-Build Team and accepted submittals and cover geotextiles with at least 3" of shoring backfill. Overlap adjacent geotextile reinforcement and retention and separation geotextiles at least 18" with seams oriented perpendicular to the wall face. Hold geotextiles in place with wire staples or anchor pins as needed.

Place reinforcement within 3" of locations shown in the plans developed by the Design-Build Team and accepted submittals and in slight tension free of kinks, folds, wrinkles or creases. Install reinforcement with the direction shown in the plans developed by the Design-Build Team and accepted submittals. For temporary wire walls with separate reinforcement and facing components, attach welded wire grid or metallic strip reinforcement to welded wire facing as shown in the accepted submittals. Do not splice or overlap reinforcement so seams are parallel to the wall face. Contact the Engineer when unanticipated existing or future obstructions such as foundations, pavements, pipes, inlets or utilities will interfere with reinforcement.

Place shoring backfill in the reinforced zone in 8" to 10" thick lifts. Compact A-2-4 soil and Class II, Type 1 and Class III select material in accordance with Subarticle 235-3(C) of the 2012 *Standard Specifications for Roads and Structures*. Use only hand operated compaction equipment to compact backfill within 3 feet of welded wire facing. At a distance greater than 3 feet, compact shoring backfill with at least 4 passes of an 8 ton to 10 ton vibratory roller in a direction parallel to the wall face. Smooth wheeled or rubber tired rollers are also acceptable for compacting backfill. Do not use sheepsfoot, grid rollers or other types of compaction equipment with feet. Do not displace or damage reinforcement when placing and compacting shoring backfill. End dumping directly on geotextile or geogrid reinforcement is not permitted. Do not operate heavy equipment on reinforcement until it is covered with at least 8" of shoring backfill. Replace any

damaged reinforcement to the satisfaction of the Engineer.

Backfill for temporary walls outside the reinforced zone in accordance with Article 410-8 of the 2012 *Standard Specifications for Roads and Structures*. Bench temporary walls into the sides of excavations where applicable. For temporary geosynthetic walls with top of wall within 5 feet of finished grade, remove top facing and incorporate top reinforcement layer into fill when placing fill in front of wall. Temporary walls remain in place permanently unless otherwise required.

TRUCK MOUNTED CHANGEABLE MESSAGE SIGNS

06/27/2012)

1101.02

DB11 R10

Revise the 2012 *Roadway Standard Drawings* as follows:

Drawing No. 1101.02, Sheet 12, TEMPORARY LANE CLOSURES, replace General Note #11 with the following:

11- TRUCK MOUNTED CHANGEABLE MESSAGE SIGNS (TMCMS) USED ON SHADOW VEHICLES FOR "IN LANE" ACTIVITIES SHALL BE A MINIMUM OF 43" X 73". THE DISPLAY PANEL SHALL HAVE FULL MATRIX CAPABILITY WITH THE CAPABILITY TO PROVIDE 2 MESSAGE LINES WITH 7 CHARACTERS PER LINE WITH A MINIMUM CHARACTER HEIGHT OF 18". FOR ADDITIONAL MESSAGING, CONTACT THE WORK ZONE TRAFFIC CONTROL SECTION.

12- TMCMS USED FOR ADVANCED WARNING ON VEHICLES LOCATED ON THE SHOULDER MAY BE SMALLER THAN 43" X 73". THE DISPLAY PANEL SHALL HAVE THE CAPABILITY TO PROVIDE 2 MESSAGE LINES WITH 7 CHARACTERS PER LINE WITH A MINIMUM CHARACTER HEIGHT OF 18". FOR ADDITIONAL MESSAGING, CONTACT THE WORK ZONE TRAFFIC CONTROL SECTION.

Drawing No. 1101.02, Sheet 13, TEMPORARY LANE CLOSURES, replace General Note #12 with the following:

12- TRUCK MOUNTED CHANGEABLE MESSAGE SIGNS (TMCMS) USED ON SHADOW VEHICLES FOR "IN LANE" ACTIVITIES SHALL BE A MINIMUM OF 43" X 73". THE DISPLAY PANEL SHALL HAVE FULL MATRIX CAPABILITY WITH THE CAPABILITY TO PROVIDE 2 MESSAGE LINES WITH 7 CHARACTERS PER LINE WITH A MINIMUM CHARACTER HEIGHT OF 18". FOR ADDITIONAL MESSAGING, CONTACT THE WORK ZONE TRAFFIC CONTROL SECTION.

13- TMCMS USED FOR ADVANCED WARNING ON VEHICLES LOCATED ON THE SHOULDER MAY BE SMALLER THAN 43" X 73". THE DISPLAY PANEL SHALL HAVE THE CAPABILITY TO PROVIDE 2 MESSAGE LINES WITH 7 CHARACTERS PER LINE WITH A MINIMUM CHARACTER HEIGHT OF 18". FOR ADDITIONAL MESSAGING, CONTACT THE WORK ZONE TRAFFIC CONTROL SECTION.

ON-THE-JOB TRAINING

(3-27-13)

Z-10

Description

The North Carolina Department of Transportation will administer a custom version of the Federal On-the-Job Training (OJT) Program, commonly referred to as the Alternate OJT Program. All contractors (existing and newcomers) will be automatically placed in the Alternate Program. Standard OJT requirements typically associated with individual projects will no longer be applied at the project level. Instead, these requirements will be applicable on an annual basis for each contractor administered by the OJT Program Manager.

On the Job Training shall meet the requirements of 23 CFR 230.107 (b), 23 USC – Section 140, this provision and the On-the-Job Training Program Manual.

The Alternate OJT Program will allow a contractor to train employees on Federal, State and privately funded projects located in North Carolina. However, priority shall be given to training employees on NCDOT Federal-Aid funded projects.

Minorities and Women

Developing, training and upgrading of minorities and women toward journeyman level status is a primary objective of this special training provision. Accordingly, the Contractor shall make every effort to enroll minority and women as trainees to the extent that such persons are available within a reasonable area of recruitment. This training commitment is not intended, and shall not be used, to discriminate against any applicant for training, whether a member of a minority group or not.

Assigning Training Goals

The Department, through the OJT Program Manager, will assign training goals for a calendar year based on the contractors' past three years' activity and the contractors' anticipated upcoming year's activity with the Department. At the beginning of each year, all contractors eligible will be contacted by the Department to determine the number of trainees that will be assigned for the upcoming calendar year. At that time the Contractor shall enter into an agreement with the Department to provide a self-imposed on-the-job training program for the calendar year. This agreement will include a specific number of annual training goals agreed to by both parties. The number of training assignments may range from 1 to 15 per contractor per calendar year. The Contractor shall sign an agreement to fulfill their annual goal for the year. A sample agreement is available at:

www.ncbowd.com/section/on-the-job-training

Training Classifications

The Contractor shall provide on-the-job training aimed at developing full journeyman level workers in the construction craft/operator positions. Preference shall be given to providing training in the following skilled work classifications:

Equipment Operators	Office Engineers
Truck Drivers	Estimators
Carpenters	Iron / Reinforcing Steel Workers
Concrete Finishers	Mechanics
Pipe Layers	Welders

The Department has established common training classifications and their respective training requirements that may be used by the contractors. However, the classifications established are not all-inclusive. Where the training is oriented toward construction applications, training will be allowed in lower-level management positions such as office engineers and estimators. Contractors shall submit new classifications for specific job functions that their employees are performing. The Department will review and recommend for acceptance to FHWA the new classifications proposed by contractors, if applicable. New classifications shall meet the following requirements:

Proposed training classifications are reasonable and realistic based on the job skill classification needs, and

The number of training hours specified in the training classification is consistent with common practices and provides enough time for the trainee to obtain journeyman level status.

The Contractor may allow trainees to be trained by a subcontractor provided that the Contractor retains primary responsibility for meeting the training and this provision is made applicable to the subcontract. However, only the Contractor will receive credit towards the annual goal for the trainee.

Where feasible, 25 percent of apprentices or trainees in each occupation shall be in their first year of apprenticeship or training. The number of trainees shall be distributed among the work classifications on the basis of the contractor's needs and the availability of journeymen in the various classifications within a reasonable area of recruitment.

No employee shall be employed as a trainee in any classification in which they have successfully completed a training course leading to journeyman level status or in which they have been employed as a journeyman.

Records and Reports

The Contractor shall maintain enrollment, monthly and completion reports documenting company compliance under these contract documents. These documents and any other

information as requested shall be submitted to the OJT Program Manager.

Upon completion and graduation of the program, the Contractor shall provide each trainee with a certification Certificate showing the type and length of training satisfactorily completed.

Trainee Interviews

All trainees enrolled in the program will receive an initial and Trainee/Post graduate interview conducted by the OJT program staff.

Trainee Wages

Contractors shall compensate trainees on a graduating pay scale based upon a percentage of the prevailing minimum journeyman wages (Davis-Bacon Act). Minimum pay shall be as follows:

60 percent	of the journeyman wage for the first half of the training period
75 percent	of the journeyman wage for the third quarter of the training period
90 percent	of the journeyman wage for the last quarter of the training period

In no instance shall a trainee be paid less than the local minimum wage. The Contractor shall adhere to the minimum hourly wage rate that will satisfy both the NC Department of Labor (NCDOL) and the Department.

Achieving or Failing to Meet Training Goals

The Contractor will be credited for each trainee employed by him on the contract work who is currently enrolled or becomes enrolled in an approved program and who receives training for at least 50 percent of the specific program requirement. Trainees will be allowed to be transferred between projects if required by the Contractor's scheduled workload to meet training goals.

If a contractor fails to attain their training assignments for the calendar year, they may be taken off the NCDOT's Bidders List.

Measurement and Payment

No compensation will be made for providing required training in accordance with these contract documents.

SANITARY SEWER

(10-07-13)

1520

SP15 R20

Revise the 2012 *Standard Specifications for Roads and Structures* as follows:

Page 15-11, Article 1520-3(A)(2) Testing, Line 5, replace the second paragraph with the following:

Test all 24" and smaller gravity sewer lines for leakage using infiltration, exfiltration, or air test. Perform visual inspection on gravity sewer lines larger than 24". Perform line and grade testing and deflection testing on all gravity sewer lines.

STANDARD SPECIAL PROVISION

AVAILABILITY OF FUNDS – TERMINATION OF CONTRACTS

(9-1-11)

Z-2

General Statute 143C-6-11. (h) Highway Appropriation is hereby incorporated verbatim in this contract as follows:

“(h) Amounts Encumbered – Transportation project appropriations may be encumbered in the amount of allotments made to the Department of Transportation by the Director for the estimated payments for transportation project contract work to be performed in the appropriation fiscal year. The allotments shall be multiyear allotments and shall be based on estimated revenues and shall be subject to the maximum contract authority contained in *General Statute 143C-6-11(c)*. Payment for transportation project work performed pursuant to contract in any fiscal year other than the current fiscal year is subject to appropriations by the General Assembly. Transportation project contracts shall contain a schedule of estimated completion progress, and any acceleration of this progress shall be subject to the approval of the Department of Transportation provided funds are available. The State reserves the right to terminate or suspend any transportation project contract, and any transportation project contract shall be so terminated or suspended if funds will not be available for payment of the work to be performed during that fiscal year pursuant to the contract. In the event of termination of any contract, the contractor shall be given a written notice of termination at least 60 days before completion of scheduled work for which funds are available. In the event of termination, the contractor shall be paid for the work already performed in accordance with the contract specifications.”

Payment will be made on any contract terminated pursuant to the special provision in accordance with Article 108-13(E), of the *North Carolina Department of Transportation Standard Specifications for Roads and Structures*, dated January 2012 and as amended by the Standard Special Provision, Division One found elsewhere in this RFP.

***** STANDARD SPECIAL PROVISIONS *****

NCDOT GENERAL SEED SPECIFICATIONS FOR SEED QUALITY

(5-7-11)

Z-3

Seed shall be sampled and tested by the North Carolina Department of Agriculture and Consumer Services, Seed Testing Laboratory. When said samples are collected, the vendor shall supply an independent laboratory report for each lot to be tested. Results from seed so sampled shall be final. Seed not meeting the specifications shall be rejected by the Department of Transportation and shall not be delivered to North Carolina Department of Transportation warehouses. If seed has been delivered it shall be available for pickup and replacement at the supplier's expense.

Any re-labeling required by the North Carolina Department of Agriculture and Consumer Services, Seed Testing Laboratory, that would cause the label to reflect as otherwise specified herein shall be rejected by the North Carolina Department of Transportation.

Seed shall be free from seeds of the noxious weeds Johnsongrass, Balloonvine, Jimsonweed, Witchweed, Itchgrass, Serrated Tussock, Showy Crotalaria, Smooth Crotalaria, Sicklepod, Sandbur, Wild Onion, and Wild Garlic. Seed shall not be labeled with the above weed species on the seed analysis label. Tolerances as applied by the Association of Official Seed Analysts will NOT be allowed for the above noxious weeds except for Wild Onion and Wild Garlic.

Tolerances established by the Association of Official Seed Analysts will generally be recognized. However, for the purpose of figuring pure live seed, the found pure seed and found germination percentages as reported by the North Carolina Department of Agriculture and Consumer Services, Seed Testing Laboratory will be used. Allowances, as established by the NCDOT, will be recognized for minimum pure live seed as listed on the following pages.

The specifications for restricted noxious weed seed refers to the number per pound as follows:

Restricted Noxious Weed	Limitations per Lb. of Seed	Restricted Noxious Weed	Limitations per Lb. of Seed
Blessed Thistle	4 seeds	Cornflower (Ragged Robin)	27 seeds
Cocklebur	4 seeds	Texas Panicum	27 seeds
Spurred Anoda	4 seeds	Bracted Plantain	54 seeds
Velvetleaf	4 seeds	Buckhorn Plantain	54 seeds
Morning-glory	8 seeds	Broadleaf Dock	54 seeds
Corn Cockle	10 seeds	Curly Dock	54 seeds
Wild Radish	12 seeds	Dodder	54 seeds
Purple Nutsedge	27 seeds	Giant Foxtail	54 seeds
Yellow Nutsedge	27 seeds	Horsenettle	54 seeds
Canada Thistle	27 seeds	Quackgrass	54 seeds
Field Bindweed	27 seeds	Wild Mustard	54 seeds
Hedge Bindweed	27 seeds		

Seed of Pensacola Bahiagrass shall not contain more than 7% inert matter, Kentucky Bluegrass, Centipede and Fine or Hard Fescue shall not contain more than 5% inert matter whereas a maximum of 2% inert matter will be allowed on all other kinds of seed. In addition, all seed shall not contain more than 2% other crop seed nor more than 1% total weed seed. The germination rate as tested by the North Carolina Department of Agriculture shall not fall below 70%, which includes both dormant and hard seed. Seed shall be labeled with not more than 7%, 5% or 2% inert matter (according to above specifications), 2% other crop seed and 1% total weed seed.

Exceptions may be made for minimum pure live seed allowances when cases of seed variety shortages are verified. Pure live seed percentages will be applied in a verified shortage situation. Those purchase orders of deficient seed lots will be credited with the percentage that the seed is deficient.

FURTHER SPECIFICATIONS FOR EACH SEED GROUP ARE GIVEN BELOW:

Minimum 85% pure live seed; maximum 1% total weed seed; maximum 2% total other crop seed; maximum 144 restricted noxious weed seed per pound. Seed less than 83% pure live seed will not be approved.

Sericea Lespedeza
Oats (seeds)

Minimum 80% pure live seed; maximum 1% total weed seed; maximum 2% total other crop; maximum 144 restricted noxious weed seed per pound. Seed less than 78% pure live seed will not be approved.

Tall Fescue (all approved varieties)	Bermudagrass
Kobe Lespedeza	Browntop Millet
Korean Lespedeza	German Millet - Strain R
Weeping Lovegrass	Clover - Red/White/Crimson
Carpetgrass	

Minimum 78% pure live seed; maximum 1% total weed seed; maximum 2% total other crop seed; maximum 144 restricted noxious weed seed per pound. Seed less than 76% pure live seed will not be approved.

Common or Sweet Sundangrass

Minimum 76% pure live seed; maximum 1% total weed seed; maximum 2% total other crop seed; maximum 144 restricted noxious weed seed per pound. Seed less than 74% pure live seed will not be approved.

Rye (grain; all varieties)
Kentucky Bluegrass (all approved varieties)
Hard Fescue (all approved varieties)
Shrub (bicolor) Lespedeza

Minimum 70% pure live seed; maximum 1% total weed seed; maximum 2% total other crop seed; maximum 144 noxious weed seed per pound. Seed less than 70% pure live seed will not be approved.

Centipede grass
Crownvetch
Pensacola Bahiagrass
Creeping Red Fescue

Japanese Millet
Reed Canary Grass
Zoysia

Minimum 70% pure live seed; maximum 1% total weed seed; maximum 2% total other crop seed; maximum 5% inert matter; maximum 144 restricted noxious weed seed per pound.

Barnyard Grass
Big Bluestem
Little Bluestem
Bristly Locust
Birdsfoot Trefoil
Indiangrass
Orchardgrass
Switchgrass
Yellow Blossom Sweet Clover

STANDARD SPECIAL PROVISION

ERRATA

(8-3-13) (Rev. 1-1-14)

Z-4

Revise the 2012 *Standard Specifications for Roads and Structures* as follows:

Division 2

Page 2-7, line 31, Article 215-2 Construction Methods, replace “Article 107-26” with “Article 107-25”.

Page 2-17, Article 226-3, Measurement and Payment, line 2, delete “pipe culverts,”.

Page 2-20, Subarticle 230-4(B), Contractor Furnished Sources, change references as follows: **Line 1,** replace “(4) Buffer Zone” with “(c) Buffer Zone”; **Line 12,** replace “(5) Evaluation for Potential Wetlands and Endangered Species” with “(d) Evaluation for Potential Wetlands and Endangered Species”; and **Line 33,** replace “(6) Approval” with “(4) Approval”.

Division 3

Page 3-1, after line 15, Article 300-2 Materials, replace “1032-9(F)” with “1032-6(F)”.

Division 4

Page 4-77, line 27, Subarticle 452-3(C) Concrete Coping, replace “sheet pile” with “reinforcement”.

Division 6

Page 6-7, line 31, Article 609-3 Field Verification of Mixture and Job Mix Formula Adjustments, replace “30” with “45”.

Page 6-10, line 42, Subarticle 609-6(C)(2), replace “Subarticle 609-6(E)” with “Subarticle 609-6(D)”.

Page 6-11, Table 609-1 Control Limits, replace “Max. Spec. Limit” for the Target Source of $P_{0.075}/P_{be}$ Ratio with “1.0”.

Page 6-40, Article 650-2 Materials, replace “Subarticle 1012-1(F)” with “Subarticle 1012-1(E)”

Division 8

Page 8-23, line 10, Article 838-2 Materials, replace “Portland Cement Concrete, Class B” with “Portland Cement Concrete, Class A”.

****NOTE** Deleted Division 10 Errata**

Division 12

Page 12-7, Table 1205-3, add “FOR THERMOPLASTIC” to the end of the title.

Page 12-8, Subarticle 1205-5(B), line 13, replace “Table 1205-2” with “Table 1205-4”.

Page 12-8, Table 1205-4 and 1205-5, replace “THERMOPLASTIC” in the title of these tables with “POLYUREA”.

Page 12-9, Subarticle 1205-6(B), line 21, replace “Table 1205-4” with “Table 1205-6”.

Page 12-11, Subarticle 1205-8(C), line 25, replace “Table 1205-5” with “Table 1205-7”.

Division 15

Page 15-4, Subarticle 1505-3(F) Backfilling, line 26, replace “Subarticle 235-4(C)” with “Subarticle 235-3(C)”.

Page 15-6, Subarticle 1510-3(B), after line 21, replace the allowable leakage formula with the following: $W = LD\sqrt{P} \div 148,000$

Page 15-6, Subarticle 1510-3(B), line 32, delete “may be performed concurrently or” and replace with “shall be performed”.

Page 15-17, Subarticle 1540-3(E), line 27, delete “Type 1”.

Division 17

Page 17-26, line 42, Subarticle 1731-3(D) Termination and Splicing within Interconnect Center, delete this subarticle.

Revise the 2012 *Roadway Standard Drawings* as follows:

1633.01 Sheet 1 of 1, English Standard Drawing for Matting Installation, replace “1633.01” with “1631.01”.

***** STANDARD SPECIAL PROVISIONS *******AWARD OF CONTRACT**

(6-28-77)

Z-6

“The North Carolina Department of Transportation, in accordance with the provisions of *Title VI of the Civil Rights Act of 1964* (78 Stat. 252) and the Regulations of the Department of Transportation (*49 C.F.R., Part 21*), issued pursuant to such act, hereby notifies all bidders that it will affirmatively insure that the contract entered into pursuant to this advertisement will be awarded to the lowest responsible bidder without discrimination on the ground of race, color, or national origin”.

***** STANDARD SPECIAL PROVISIONS *****

MINORITY AND FEMALE EMPLOYMENT REQUIREMENTS

(12-18-07)

Z-7

NOTICE OF REQUIREMENTS FOR AFFIRMATIVE ACTION TO ENSURE EQUAL EMPLOYMENT OPPORTUNITY (*EXECUTIVE NUMBER 11246*)

1. The goals and timetables for minority and female participation, expressed in percentage terms for the Contractor's aggregate workforce in each trade on all construction work in the covered area, see as shown on the attached sheet entitled "Employment Goals for Minority and Female Participation".

These goals are applicable to all the Contractor's construction work (whether or not it is Federal or federally assisted) performed in the covered area. If the Contractor performs construction work in a geographical area located outside of the covered area, it shall apply the goals established for such geographical area where the work is actually performed. With regard to this second area, the Contractor also is subject to the goals for both its federally involved and nonfederally involved construction.

The Contractor's compliance with the Executive Order and the regulations in *41 CFR Part 60-4* shall be based on its implementation of the Equal Opportunity Clause, specific affirmative action obligations required by the specifications set forth in *41 CFR 60-4.3(a)*, and its effort to meet the goals. The hours of minority and female employment and training must be substantially uniform throughout the length of the contract, and in each trade and the Contractor shall make a good faith effort to employ minorities and women evenly on each of its projects. The transfer of minority or female employees or trainees from Contractor to Contractor or from project to project or the sole purpose of meeting the Contractor's goals shall be a violation of the contract, the executive Order and the regulations in *41 CFR Part 60-4*. Compliance with the goals will be measured against the total work hours performed.

2. As used in this Notice and in the contract resulting from this solicitation, the "covered area" is the county or counties shown on the cover sheet of the proposal form and contract.

**EMPLOYMENT GOALS FOR MINORITY
AND FEMALE PARTICIPATION**

Economic Areas

Area 023 29.7%

Bertie County
Camden County
Chowan County
Gates County
Hertford County
Pasquotank County
Perquimans County

Area 024 31.7%

Beaufort County
Carteret County
Craven County
Dare County
Edgecombe County
Green County
Halifax County
Hyde County
Jones County
Lenoir County
Martin County
Nash County
Northampton County
Pamlico County
Pitt County
Tyrrell County
Washington County
Wayne County
Wilson County

Area 025 23.5%

Columbus County
Duplin County
Onslow County
Pender County

Area 026 33.5%

Bladen County
Hoke County
Richmond County
Robeson County
Sampson County
Scotland County

Area 027 24.7%

Chatham County
Franklin County
Granville County
Harnett County
Johnston County
Lee County
Person County
Vance County
Warren County

Area 028 15.5%

Alleghany County
Ashe County
Caswell County
Davie County
Montgomery County
Moore County
Rockingham County
Surry County
Watauga County
Wilkes County

Area 029 15.7%

Alexander County
Anson County
Burke County
Cabarrus County
Caldwell County
Catawba County
Cleveland County
Iredell County
Lincoln County
Polk County
Rowan County
Rutherford County
Stanly County

Area 0480 8.5%

Buncombe County
Madison County

Area 030 6.3%

Avery County
Cherokee County
Clay County
Graham County
Haywood County
Henderson County
Jackson County
McDowell County
Macon County
Mitchell County
Swain County
Transylvania County
Yancey County

SMSA Areas

Area 5720 26.6%

Currituck County

Area 9200 20.7%

Brunswick County

New Hanover County

Area 2560 24.2%

Cumberland County

Area 6640 22.8%

Durham County

Orange County

Wake County

Area 1300 16.2%

Alamance County

Area 3120 16.4%

Davidson County

Forsyth County

Guilford County

Randolph County

Stokes County

Yadkin County

Area 1520 18.3%

Gaston County

Mecklenburg County

Union County

Goals for Female

Participation in Each Trade

(Statewide) 6.9%

STANDARD SPECIAL PROVISION**REQUIRED CONTRACT PROVISIONS FEDERAL - AID CONSTRUCTION CONTRACTS**

FHWA - 1273 Electronic Version - May 1, 2012

Z-8

- I. General
- II. Nondiscrimination
- III. Nonsegregated Facilities
- IV. Davis-Bacon and Related Act Provisions
- V. Contract Work Hours and Safety Standards Act Provisions
- VI. Subletting or Assigning the Contract
- VII. Safety: Accident Prevention
- VIII. False Statements Concerning Highway Projects
- IX. Implementation of Clean Air Act and Federal Water Pollution Control Act
- X. Compliance with Governmentwide Suspension and Debarment Requirements
- XI. Certification Regarding Use of Contract Funds for Lobbying

ATTACHMENTS

- A. Employment and Materials Preference for Appalachian Development Highway System or Appalachian Local Access Road Contracts (included in Appalachian contracts only)

I. GENERAL

1. Form FHWA-1273 must be physically incorporated in each construction contract funded under Title 23 (excluding emergency contracts solely intended for debris removal). The contractor (or subcontractor) must insert this form in each subcontract and further require its inclusion in all lower tier subcontracts (excluding purchase orders, rental agreements and other agreements for supplies or services).
The applicable requirements of Form FHWA-1273 are incorporated by reference for work done under any purchase order, rental agreement or agreement for other services. The prime contractor shall be responsible for compliance by any subcontractor, lower-tier subcontractor or service provider.
Form FHWA-1273 must be included in all Federal-aid design-build contracts, in all subcontracts and in lower tier subcontracts (excluding subcontracts for design services, purchase orders, rental agreements and other agreements for supplies or services). The design-builder shall be responsible for compliance by any subcontractor, lower-tier subcontractor or service provider.
Contracting agencies may reference Form FHWA-1273 in bid proposal or request for proposal documents, however, the Form FHWA-1273 must be physically incorporated (not referenced) in all contracts, subcontracts and lower-tier subcontracts (excluding purchase orders, rental agreements and other agreements for supplies or services related to a construction contract).
2. Subject to the applicability criteria noted in the following sections, these contract provisions shall apply to all work performed on the contract by the contractor's own organization and with the assistance of workers under the contractor's immediate superintendence and to all work performed on the contract by piecework, station work, or by subcontract.
3. A breach of any of the stipulations contained in these Required Contract Provisions may be sufficient grounds for withholding of progress payments, withholding of final payment, termination of the contract, suspension / debarment or any other action determined to be appropriate by the contracting agency and FHWA.
4. Selection of Labor: During the performance of this contract, the contractor shall not use convict labor for any purpose within the limits of a construction project on a Federal-aid highway unless it is labor performed by convicts who are on parole, supervised release, or probation. The term Federal-aid highway does not include roadways functionally classified as local roads or rural minor collectors.

II. NONDISCRIMINATION

The provisions of this section related to 23 CFR Part 230 are applicable to all Federal-aid construction contracts and to all related construction subcontracts of \$10,000 or more. The provisions of 23 CFR Part 230 are not applicable to material supply, engineering, or architectural service contracts.

In addition, the contractor and all subcontractors must comply with the following policies: Executive Order 11246, 41 CFR 60, 29 CFR 1625-1627, Title 23 USC Section 140, the Rehabilitation Act of 1973, as amended (29 USC 794), Title VI of the Civil Rights Act of 1964, as amended, and related regulations including 49 CFR Parts 21, 26 and 27; and 23 CFR Parts 200, 230, and 633.

The contractor and all subcontractors must comply with: the requirements of the Equal Opportunity Clause in 41 CFR 60-1.4(b) and, for all construction contracts exceeding \$10,000, the Standard Federal Equal Employment Opportunity Construction Contract Specifications in 41 CFR 60-4.3.

Note: The U.S. Department of Labor has exclusive authority to determine compliance with Executive Order 11246 and the policies of the Secretary of Labor including 41 CFR 60, and 29 CFR 1625-1627. The contracting agency and the FHWA have the authority and the responsibility to ensure compliance with Title 23 USC Section 140, the Rehabilitation Act of 1973, as amended (29 USC 794), and Title VI of the Civil Rights Act of 1964, as amended, and related regulations including 49 CFR Parts 21, 26 and 27; and 23 CFR Parts 200, 230, and 633.

The following provision is adopted from 23 CFR 230, Appendix A, with appropriate revisions to conform to the U.S. Department of Labor (US DOL) and FHWA requirements.

1. **Equal Employment Opportunity:** Equal employment opportunity (EEO) requirements not to discriminate and to take affirmative action to assure equal opportunity as set forth under laws, executive orders, rules, regulations (28 CFR 35, 29 CFR 1630, 29 CFR 1625-1627, 41 CFR 60 and 49 CFR 27) and orders of the Secretary of Labor as modified by the provisions prescribed herein, and imposed pursuant to 23 U.S.C. 140 shall constitute the EEO and specific affirmative action standards for the contractor's project activities under this contract. The provisions of the Americans with Disabilities Act of 1990 (42 U.S.C. 12101 et seq.) set forth under 28 CFR 35 and 29 CFR 1630 are

incorporated by reference in this contract. In the execution of this contract, the contractor agrees to comply with the following minimum specific requirement activities of EEO:

- a. The contractor will work with the contracting agency and the Federal Government to ensure that it has made every good faith effort to provide equal opportunity with respect to all of its terms and conditions of employment and in their review of activities under the contract.
- b. The contractor will accept as its operating policy the following statement:
"It is the policy of this Company to assure that applicants are employed, and that employees are treated during employment, without regard to their race, religion, sex, color, national origin, age or disability. Such action shall include: employment, upgrading, demotion, or transfer; recruitment or recruitment advertising; layoff or termination; rates of pay or other forms of compensation; and selection for training, including apprenticeship, pre-apprenticeship, and/or on-the-job training."
2. **EEO Officer:** The contractor will designate and make known to the contracting officers an EEO Officer who will have the responsibility for and must be capable of effectively administering and promoting an active EEO program and who must be assigned adequate authority and responsibility to do so.
3. **Dissemination of Policy:** All members of the contractor's staff who are authorized to hire, supervise, promote, and discharge employees, or who recommend such action, or who are substantially involved in such action, will be made fully cognizant of, and will implement, the contractor's EEO policy and contractual responsibilities to provide EEO in each grade and classification of employment. To ensure that the above agreement will be met, the following actions will be taken as a minimum:
 - a. Periodic meetings of supervisory and personnel office employees will be conducted before the start of work and then not less often than once every six months, at which time the contractor's EEO policy and its implementation will be reviewed and explained. The meetings will be conducted by the EEO Officer.
 - b. All new supervisory or personnel office employees will be given a thorough indoctrination by the EEO Officer, covering all major aspects of the contractor's EEO obligations within thirty days following their reporting for duty with the contractor.
 - c. All personnel who are engaged in direct recruitment for the project will be instructed by the EEO Officer in the contractor's procedures for locating and hiring minorities and women.
 - d. Notices and posters setting forth the contractor's EEO policy will be placed in areas readily accessible to employees, applicants for employment and potential employees.
 - e. The contractor's EEO policy and the procedures to implement such policy will be brought to the attention of employees by means of meetings, employee handbooks, or other appropriate means.
4. **Recruitment:** When advertising for employees, the contractor will include in all advertisements for employees the notation: "An Equal Opportunity Employer." All such advertisements will be placed in publications having a large circulation among minorities and women in the area from which the project work force would normally be derived.
 - a. The contractor will, unless precluded by a valid bargaining agreement, conduct systematic and direct recruitment through public and private employee referral sources likely to yield qualified minorities and women. To meet this requirement, the contractor will identify sources of potential minority group employees, and establish with such identified sources procedures whereby minority and women applicants may be referred to the contractor for employment consideration.
 - b. In the event the contractor has a valid bargaining agreement providing for exclusive hiring hall referrals, the contractor is expected to observe the provisions of that agreement to the extent that the system meets the contractor's compliance with EEO contract provisions. Where implementation of such an agreement has the effect of discriminating against minorities or women, or obligates the contractor to do the same, such implementation violates Federal nondiscrimination provisions.
 - c. The contractor will encourage its present employees to refer minorities and women as applicants for employment. Information and procedures with regard to referring such applicants will be discussed with employees.
5. **Personnel Actions:** Wages, working conditions, and employee benefits shall be established and administered, and personnel actions of every type, including hiring, upgrading, promotion, transfer, demotion, layoff, and termination, shall be taken without regard to race, color, religion, sex, national origin, age or disability. The following procedures shall be followed:
 - a. The contractor will conduct periodic inspections of project sites to insure that working conditions and employee facilities do not indicate discriminatory treatment of project site personnel.
 - b. The contractor will periodically evaluate the spread of wages paid within each classification to determine any evidence of discriminatory wage practices.
 - c. The contractor will periodically review selected personnel actions in depth to determine whether there is evidence of discrimination. Where evidence is found, the contractor will promptly take corrective action. If the review indicates that the discrimination may extend beyond the actions reviewed, such corrective action shall include all affected persons.
 - d. The contractor will promptly investigate all complaints of alleged discrimination made to the contractor in connection with its obligations under this contract, will attempt to resolve such complaints, and will take appropriate corrective action within a reasonable time. If the investigation indicates that the discrimination may affect persons other than the complainant, such corrective action shall include such other persons. Upon completion of each investigation, the contractor will inform every complainant of all of their avenues of appeal.
6. **Training and Promotion:**
 - a. The contractor will assist in locating, qualifying, and increasing the skills of minorities and women who are applicants for employment or current employees. Such efforts should be aimed at developing full journey level status employees in the type of trade or job classification involved.
 - b. Consistent with the contractor's work force requirements and as permissible under Federal and State regulations, the contractor shall make full use of training programs, i.e., apprenticeship, and on-the-job training programs for the geographical area of contract performance. In the event a special provision for training is provided under this contract, this subparagraph will be superseded as indicated in the special provision. The contracting agency may reserve training positions for persons who receive welfare assistance in accordance with 23 U.S.C. 140(a).
 - c. The contractor will advise employees and applicants for employment of available training programs and entrance requirements for each.
 - d. The contractor will periodically review the training and promotion potential of employees who are minorities and women and will encourage eligible employees to apply for such training and promotion.
7. **Unions:** If the contractor relies in whole or in part upon unions as a source of employees, the contractor will use good faith efforts to obtain the cooperation of such unions to increase opportunities for minorities and women. Actions by the contractor, either directly or through a contractor's association acting as agent, will include the procedures set forth below:

- a. The contractor will use good faith efforts to develop, in cooperation with the unions, joint training programs aimed toward qualifying more minorities and women for membership in the unions and increasing the skills of minorities and women so that they may qualify for higher paying employment.
 - b. The contractor will use good faith efforts to incorporate an EEO clause into each union agreement to the end that such union will be contractually bound to refer applicants without regard to their race, color, religion, sex, national origin, age or disability.
 - c. The contractor is to obtain information as to the referral practices and policies of the labor union except that to the extent such information is within the exclusive possession of the labor union and such labor union refuses to furnish such information to the contractor, the contractor shall so certify to the contracting agency and shall set forth what efforts have been made to obtain such information.
 - d. In the event the union is unable to provide the contractor with a reasonable flow of referrals within the time limit set forth in the collective bargaining agreement, the contractor will, through independent recruitment efforts, fill the employment vacancies without regard to race, color, religion, sex, national origin, age or disability; making full efforts to obtain qualified and/or qualifiable minorities and women. The failure of a union to provide sufficient referrals (even though it is obligated to provide exclusive referrals under the terms of a collective bargaining agreement) does not relieve the contractor from the requirements of this paragraph. In the event the union referral practice prevents the contractor from meeting the obligations pursuant to Executive Order 11246, as amended, and these special provisions, such contractor shall immediately notify the contracting agency.
8. **Reasonable Accommodation for Applicants / Employees with Disabilities:** The contractor must be familiar with the requirements for and comply with the Americans with Disabilities Act and all rules and regulations established there under. Employers must provide reasonable accommodation in all employment activities unless to do so would cause an undue hardship.
 9. **Selection of Subcontractors, Procurement of Materials and Leasing of Equipment:** The contractor shall not discriminate on the grounds of race, color, religion, sex, national origin, age or disability in the selection and retention of subcontractors, including procurement of materials and leases of equipment. The contractor shall take all necessary and reasonable steps to ensure nondiscrimination in the administration of this contract.
 - a. The contractor shall notify all potential subcontractors and suppliers and lessors of their EEO obligations under this contract.
 - b. The contractor will use good faith efforts to ensure subcontractor compliance with their EEO obligations.
 10. **Assurance Required by 49 CFR 26.13(b):**
 - a. The requirements of 49 CFR Part 26 and the State DOT's U.S. DOT-approved DBE program are incorporated by reference.
 - b. The contractor or subcontractor shall not discriminate on the basis of race, color, national origin, or sex in the performance of this contract. The contractor shall carry out applicable requirements of 49 CFR Part 26 in the award and administration of DOT-assisted contracts. Failure by the contractor to carry out these requirements is a material breach of this contract, which may result in the termination of this contract or such other remedy as the contracting agency deems appropriate.
 11. **Records and Reports:** The contractor shall keep such records as necessary to document compliance with the EEO requirements. Such records shall be retained for a period of three years following the date of the final payment to the contractor for all contract work and shall be available at reasonable times and places for inspection by authorized representatives of the contracting agency and the FHWA.
 - a. The records kept by the contractor shall document the following:
 - (1) The number and work hours of minority and non-minority group members and women employed in each work classification on the project;
 - (2) The progress and efforts being made in cooperation with unions, when applicable, to increase employment opportunities for minorities and women; and
 - (3) The progress and efforts being made in locating, hiring, training, qualifying, and upgrading minorities and women;
 - b. The contractors and subcontractors will submit an annual report to the contracting agency each July for the duration of the project, indicating the number of minority, women, and non-minority group employees currently engaged in each work classification required by the contract work. This information is to be reported on Form FHWA-1391. The staffing data should represent the project work force on board in all or any part of the last payroll period preceding the end of July. If on-the-job training is being required by special provision, the contractor will be required to collect and report training data. The employment data should reflect the work force on board during all or any part of the last payroll period preceding the end of July.

III. NONSEGREGATED FACILITIES

This provision is applicable to all Federal-aid construction contracts and to all related construction subcontracts of \$10,000 or more.

The contractor must ensure that facilities provided for employees are provided in such a manner that segregation on the basis of race, color, religion, sex, or national origin cannot result. The contractor may neither require such segregated use by written or oral policies nor tolerate such use by employee custom. The contractor's obligation extends further to ensure that its employees are not assigned to perform their services at any location, under the contractor's control, where the facilities are segregated. The term "facilities" includes waiting rooms, work areas, restaurants and other eating areas, time clocks, restrooms, washrooms, locker rooms, and other storage or dressing areas, parking lots, drinking fountains, recreation or entertainment areas, transportation, and housing provided for employees. The contractor shall provide separate or single-user restrooms and necessary dressing or sleeping areas to assure privacy between sexes.

IV. DAVIS-BACON AND RELATED ACT PROVISIONS

This section is applicable to all Federal-aid construction projects exceeding \$2,000 and to all related subcontracts and lower-tier subcontracts (regardless of subcontract size). The requirements apply to all projects located within the right-of-way of a roadway that is functionally classified as Federal-aid highway. This excludes roadways functionally classified as local roads or rural minor collectors, which are exempt. Contracting agencies may elect to apply these requirements to other projects.

The following provisions are from the U.S. Department of Labor regulations in 29 CFR 5.5 "Contract provisions and related matters" with minor revisions to conform to the FHWA-1273 format and FHWA program requirements.

1. Minimum wages

- a. All laborers and mechanics employed or working upon the site of the work, will be paid unconditionally and not less often than once a week, and without subsequent deduction or rebate on any account (except such payroll deductions as are permitted by regulations issued by the Secretary of Labor under the Copeland Act (29 CFR part 3)), the full amount of wages and bona fide fringe benefits (or cash equivalents thereof) due at time of payment computed at rates not less than those contained in the wage determination of the Secretary of Labor which is

attached hereto and made a part hereof, regardless of any contractual relationship which may be alleged to exist between the contractor and such laborers and mechanics.

Contributions made or costs reasonably anticipated for bona fide fringe benefits under section 1(b)(2) of the Davis-Bacon Act on behalf of laborers or mechanics are considered wages paid to such laborers or mechanics, subject to the provisions of paragraph 1.d. of this section; also, regular contributions made or costs incurred for more than a weekly period (but not less often than quarterly) under plans, funds, or programs which cover the particular weekly period, are deemed to be constructively made or incurred during such weekly period. Such laborers and mechanics shall be paid the appropriate wage rate and fringe benefits on the wage determination for the classification of work actually performed, without regard to skill, except as provided in 29 CFR 5.5(a)(4). Laborers or mechanics performing work in more than one classification may be compensated at the rate specified for each classification for the time actually worked therein: Provided, That the employer's payroll records accurately set forth the time spent in each classification in which work is performed. The wage determination (including any additional classification and wage rates conformed under paragraph 1.b. of this section) and the Davis-Bacon poster (WH-1321) shall be posted at all times by the contractor and its subcontractors at the site of the work in a prominent and accessible place where it can be easily seen by the workers.

- b. (1) The contracting officer shall require that any class of laborers or mechanics, including helpers, which is not listed in the wage determination and which is to be employed under the contract shall be classified in conformance with the wage determination. The contracting officer shall approve an additional classification and wage rate and fringe benefits therefore only when the following criteria have been met:
 - (i) The work to be performed by the classification requested is not performed by a classification in the wage determination; and
 - (ii) The classification is utilized in the area by the construction industry; and
 - (iii) The proposed wage rate, including any bona fide fringe benefits, bears a reasonable relationship to the wage rates contained in the wage determination.
 - (2) If the contractor and the laborers and mechanics to be employed in the classification (if known), or their representatives, and the contracting officer agree on the classification and wage rate (including the amount designated for fringe benefits where appropriate), a report of the action taken shall be sent by the contracting officer to the Administrator of the Wage and Hour Division, Employment Standards Administration, U.S. Department of Labor, Washington, DC 20210. The Administrator, or an authorized representative, will approve, modify, or disapprove every additional classification action within 30 days of receipt and so advise the contracting officer or will notify the contracting officer within the 30-day period that additional time is necessary.
 - (3) In the event the contractor, the laborers or mechanics to be employed in the classification or their representatives, and the contracting officer do not agree on the proposed classification and wage rate (including the amount designated for fringe benefits, where appropriate), the contracting officer shall refer the questions, including the views of all interested parties and the recommendation of the contracting officer, to the Wage and Hour Administrator for determination. The Wage and Hour Administrator, or an authorized representative, will issue a determination within 30 days of receipt and so advise the contracting officer or will notify the contracting officer within the 30-day period that additional time is necessary.
 - (4) The wage rate (including fringe benefits where appropriate) determined pursuant to paragraphs 1.b.(2) or 1.b.(3) of this section, shall be paid to all workers performing work in the classification under this contract from the first day on which work is performed in the classification.
- c. Whenever the minimum wage rate prescribed in the contract for a class of laborers or mechanics includes a fringe benefit which is not expressed as an hourly rate, the contractor shall either pay the benefit as stated in the wage determination or shall pay another bona fide fringe benefit or an hourly cash equivalent thereof.
 - d. If the contractor does not make payments to a trustee or other third person, the contractor may consider as part of the wages of any laborer or mechanic the amount of any costs reasonably anticipated in providing bona fide fringe benefits under a plan or program, Provided, That the Secretary of Labor has found, upon the written request of the contractor, that the applicable standards of the Davis-Bacon Act have been met. The Secretary of Labor may require the contractor to set aside in a separate account assets for the meeting of obligations under the plan or program.
2. **Withholding.** The contracting agency shall upon its own action or upon written request of an authorized representative of the Department of Labor, withhold or cause to be withheld from the contractor under this contract, or any other Federal contract with the same prime contractor, or any other federally-assisted contract subject to Davis-Bacon prevailing wage requirements, which is held by the same prime contractor, so much of the accrued payments or advances as may be considered necessary to pay laborers and mechanics, including apprentices, trainees, and helpers, employed by the contractor or any subcontractor the full amount of wages required by the contract. In the event of failure to pay any laborer or mechanic, including any apprentice, trainee, or helper, employed or working on the site of the work, all or part of the wages required by the contract, the contracting agency may, after written notice to the contractor, take such action as may be necessary to cause the suspension of any further payment, advance, or guarantee of funds until such violations have ceased.
 3. **Payrolls and basic records**
 - a. Payrolls and basic records relating thereto shall be maintained by the contractor during the course of the work and preserved for a period of three years thereafter for all laborers and mechanics working at the site of the work. Such records shall contain the name, address, and social security number of each such worker, his or her correct classification, hourly rates of wages paid (including rates of contributions or costs anticipated for bona fide fringe benefits or cash equivalents thereof of the types described in section 1(b)(2)(B) of the Davis-Bacon Act), daily and weekly number of hours worked, deductions made and actual wages paid. Whenever the Secretary of Labor has found under 29 CFR 5.5(a)(1)(iv) that the wages of any laborer or mechanic include the amount of any costs reasonably anticipated in providing benefits under a plan or program described in section 1(b)(2)(B) of the Davis-Bacon Act, the contractor shall maintain records which show that the commitment to provide such benefits is enforceable, that the plan or program is financially responsible, and that the plan or program has been communicated in writing to the laborers or mechanics affected, and records which show the costs anticipated or the actual cost incurred in providing such benefits. Contractors employing apprentices or trainees under approved programs shall maintain written evidence of the registration of apprenticeship programs and certification of trainee programs, the registration of the apprentices and trainees, and the ratios and wage rates prescribed in the applicable programs.
 - b. (1) The contractor shall submit weekly for each week in which any contract work is performed a copy of all payrolls to the contracting agency. The payrolls submitted shall set out accurately and completely all of the information required to be maintained under 29 CFR 5.5(a)(3)(i), except that full social security numbers and home addresses shall not be included on weekly transmittals. Instead the payrolls shall only need to include an individually identifying number for each employee (e.g. , the last four digits of the employee's social security number). The required weekly payroll information may be submitted in any form desired. Optional Form WH-347 is

available for this purpose from the Wage and Hour Division Web site at <http://www.dol.gov/esa/whd/forms/wh347instr.htm> or its successor site. The prime contractor is responsible for the submission of copies of payrolls by all subcontractors. Contractors and subcontractors shall maintain the full social security number and current address of each covered worker, and shall provide them upon request to the contracting agency for transmission to the State DOT, the FHWA or the Wage and Hour Division of the Department of Labor for purposes of an investigation or audit of compliance with prevailing wage requirements. It is not a violation of this section for a prime contractor to require a subcontractor to provide addresses and social security numbers to the prime contractor for its own records, without weekly submission to the contracting agency.

- (2) Each payroll submitted shall be accompanied by a "Statement of Compliance," signed by the contractor or subcontractor or his or her agent who pays or supervises the payment of the persons employed under the contract and shall certify the following:
 - (i) That the payroll for the payroll period contains the information required to be provided under §5.5 (a)(3)(ii) of Regulations, 29 CFR part 5, the appropriate information is being maintained under §5.5 (a)(3)(i) of Regulations, 29 CFR part 5, and that such information is correct and complete;
 - (ii) That each laborer or mechanic (including each helper, apprentice, and trainee) employed on the contract during the payroll period has been paid the full weekly wages earned, without rebate, either directly or indirectly, and that no deductions have been made either directly or indirectly from the full wages earned, other than permissible deductions as set forth in Regulations, 29 CFR part 3;
 - (iii) That each laborer or mechanic has been paid not less than the applicable wage rates and fringe benefits or cash equivalents for the classification of work performed, as specified in the applicable wage determination incorporated into the contract.
 - (3) The weekly submission of a properly executed certification set forth on the reverse side of Optional Form WH-347 shall satisfy the requirement for submission of the "Statement of Compliance" required by paragraph 3.b.(2) of this section.
 - (4) The falsification of any of the above certifications may subject the contractor or subcontractor to civil or criminal prosecution under section 1001 of title 18 and section 231 of title 31 of the United States Code.
- c. The contractor or subcontractor shall make the records required under paragraph 3.a. of this section available for inspection, copying, or transcription by authorized representatives of the contracting agency, the State DOT, the FHWA, or the Department of Labor, and shall permit such representatives to interview employees during working hours on the job. If the contractor or subcontractor fails to submit the required records or to make them available, the FHWA may, after written notice to the contractor, the contracting agency or the State DOT, take such action as may be necessary to cause the suspension of any further payment, advance, or guarantee of funds. Furthermore, failure to submit the required records upon request or to make such records available may be grounds for debarment action pursuant to 29 CFR 5.12.

4. Apprentices and trainees

- a. Apprentices (programs of the USDOL). Apprentices will be permitted to work at less than the predetermined rate for the work they performed when they are employed pursuant to and individually registered in a bona fide apprenticeship program registered with the U.S. Department of Labor, Employment and Training Administration, Office of Apprenticeship Training, Employer and Labor Services, or with a State Apprenticeship Agency recognized by the Office, or if a person is employed in his or her first 90 days of probationary employment as an apprentice in such an apprenticeship program, who is not individually registered in the program, but who has been certified by the Office of Apprenticeship Training, Employer and Labor Services or a State Apprenticeship Agency (where appropriate) to be eligible for probationary employment as an apprentice.

The allowable ratio of apprentices to journeymen on the job site in any craft classification shall not be greater than the ratio permitted to the contractor as to the entire work force under the registered program. Any worker listed on a payroll at an apprentice wage rate, who is not registered or otherwise employed as stated above, shall be paid not less than the applicable wage rate on the wage determination for the classification of work actually performed. In addition, any apprentice performing work on the job site in excess of the ratio permitted under the registered program shall be paid not less than the applicable wage rate on the wage determination for the work actually performed. Where a contractor is performing construction on a project in a locality other than that in which its program is registered, the ratios and wage rates (expressed in percentages of the journeyman's hourly rate) specified in the contractor's or subcontractor's registered program shall be observed.

Every apprentice must be paid at not less than the rate specified in the registered program for the apprentice's level of progress, expressed as a percentage of the journeymen hourly rate specified in the applicable wage determination. Apprentices shall be paid fringe benefits in accordance with the provisions of the apprenticeship program. If the apprenticeship program does not specify fringe benefits, apprentices must be paid the full amount of fringe benefits listed on the wage determination for the applicable classification. If the Administrator determines that a different practice prevails for the applicable apprentice classification, fringes shall be paid in accordance with that determination.

In the event the Office of Apprenticeship Training, Employer and Labor Services, or a State Apprenticeship Agency recognized by the Office, withdraws approval of an apprenticeship program, the contractor will no longer be permitted to utilize apprentices at less than the applicable predetermined rate for the work performed until an acceptable program is approved.

- b. Trainees (programs of the USDOL). Except as provided in 29 CFR 5.16, trainees will not be permitted to work at less than the predetermined rate for the work performed unless they are employed pursuant to and individually registered in a program which has received prior approval, evidenced by formal certification by the U.S. Department of Labor, Employment and Training Administration.

The ratio of trainees to journeymen on the job site shall not be greater than permitted under the plan approved by the Employment and Training Administration.

Every trainee must be paid at not less than the rate specified in the approved program for the trainee's level of progress, expressed as a percentage of the journeyman hourly rate specified in the applicable wage determination. Trainees shall be paid fringe benefits in accordance with the provisions of the trainee program. If the trainee program does not mention fringe benefits, trainees shall be paid the full amount of fringe benefits listed on the wage determination unless the Administrator of the Wage and Hour Division determines that there is an apprenticeship program associated with the corresponding journeyman wage rate on the wage determination which provides for less than full fringe benefits for apprentices. Any employee listed on the payroll at a trainee rate who is not registered and participating in a training plan approved by the Employment and Training Administration shall be paid not less than the applicable wage rate on the wage determination for the classification of work actually performed. In addition, any trainee performing work on the job site in excess of the ratio permitted under the registered program shall be paid not less than the applicable wage rate on the wage determination for the work actually performed.

In the event the Employment and Training Administration withdraws approval of a training program, the contractor will no longer be permitted to utilize trainees at less than the applicable predetermined rate for the work performed until an acceptable program is approved.

- c. Equal employment opportunity. The utilization of apprentices, trainees and journeymen under this part shall be in conformity with the equal employment opportunity requirements of Executive Order 11246, as amended, and 29 CFR part 30.
- d. Apprentices and Trainees (programs of the U.S. DOT). Apprentices and trainees working under apprenticeship and skill training programs which have been certified by the Secretary of Transportation as promoting EEO in connection with Federal-aid highway construction programs are not subject to the requirements of paragraph 4 of this Section IV. The straight time hourly wage rates for apprentices and trainees under such programs will be established by the particular programs. The ratio of apprentices and trainees to journeymen shall not be greater than permitted by the terms of the particular program.
- 5. **Compliance with Copeland Act requirements.** The contractor shall comply with the requirements of 29 CFR part 3, which are incorporated by reference in this contract.
- 6. **Subcontracts.** The contractor or subcontractor shall insert Form FHWA-1273 in any subcontracts and also require the subcontractors to include Form FHWA-1273 in any lower tier subcontracts. The prime contractor shall be responsible for the compliance by any subcontractor or lower tier subcontractor with all the contract clauses in 29 CFR 5.5.
- 7. **Contract termination:** debarment. A breach of the contract clauses in 29 CFR 5.5 may be grounds for termination of the contract, and for debarment as a contractor and a subcontractor as provided in 29 CFR 5.12.
- 8. **Compliance with Davis-Bacon and Related Act requirements.** All rulings and interpretations of the Davis-Bacon and Related Acts contained in 29 CFR parts 1, 3, and 5 are herein incorporated by reference in this contract.
- 9. **Disputes concerning labor standards.** Disputes arising out of the labor standards provisions of this contract shall not be subject to the general disputes clause of this contract. Such disputes shall be resolved in accordance with the procedures of the Department of Labor set forth in 29 CFR parts 5, 6, and 7. Disputes within the meaning of this clause include disputes between the contractor (or any of its subcontractors) and the contracting agency, the U.S. Department of Labor, or the employees or their representatives.
- 10. **Certification of eligibility.**
 - a. By entering into this contract, the contractor certifies that neither it (nor he or she) nor any person or firm who has an interest in the contractor's firm is a person or firm ineligible to be awarded Government contracts by virtue of section 3(a) of the Davis-Bacon Act or 29 CFR 5.12(a)(1).
 - b. No part of this contract shall be subcontracted to any person or firm ineligible for award of a Government contract by virtue of section 3(a) of the Davis-Bacon Act or 29 CFR 5.12(a)(1).
 - c. The penalty for making false statements is prescribed in the U.S. Criminal Code, 18 U.S.C. 1001.

V. CONTRACT WORK HOURS AND SAFETY STANDARDS ACT

The following clauses apply to any Federal-aid construction contract in an amount in excess of \$100,000 and subject to the overtime provisions of the Contract Work Hours and Safety Standards Act. These clauses shall be inserted in addition to the clauses required by 29 CFR 5.5(a) or 29 CFR 4.6. As used in this paragraph, the terms laborers and mechanics include watchmen and guards.

- 1. **Overtime requirements.** No contractor or subcontractor contracting for any part of the contract work which may require or involve the employment of laborers or mechanics shall require or permit any such laborer or mechanic in any workweek in which he or she is employed on such work to work in excess of forty hours in such workweek unless such laborer or mechanic receives compensation at a rate not less than one and one-half times the basic rate of pay for all hours worked in excess of forty hours in such workweek.
- 2. **Violation; liability for unpaid wages; liquidated damages.** In the event of any violation of the clause set forth in paragraph (1.) of this section, the contractor and any subcontractor responsible therefor shall be liable for the unpaid wages. In addition, such contractor and subcontractor shall be liable to the United States (in the case of work done under contract for the District of Columbia or a territory, to such District or to such territory), for liquidated damages. Such liquidated damages shall be computed with respect to each individual laborer or mechanic, including watchmen and guards, employed in violation of the clause set forth in paragraph (1.) of this section, in the sum of \$10 for each calendar day on which such individual was required or permitted to work in excess of the standard workweek of forty hours without payment of the overtime wages required by the clause set forth in paragraph (1.) of this section.
- 3. **Withholding for unpaid wages and liquidated damages.** The FHWA or the contracting agency shall upon its own action or upon written request of an authorized representative of the Department of Labor withhold or cause to be withheld, from any moneys payable on account of work performed by the contractor or subcontractor under any such contract or any other Federal contract with the same prime contractor, or any other federally-assisted contract subject to the Contract Work Hours and Safety Standards Act, which is held by the same prime contractor, such sums as may be determined to be necessary to satisfy any liabilities of such contractor or subcontractor for unpaid wages and liquidated damages as provided in the clause set forth in paragraph (2.) of this section.
- 4. **Subcontracts.** The contractor or subcontractor shall insert in any subcontracts the clauses set forth in paragraph (1.) through (4.) of this section and also a clause requiring the subcontractors to include these clauses in any lower tier subcontracts. The prime contractor shall be responsible for compliance by any subcontractor or lower tier subcontractor with the clauses set forth in paragraphs (1.) through (4.) of this section.

VI. SUBLETTING OR ASSIGNING THE CONTRACT

This provision is applicable to all Federal-aid construction contracts on the National Highway System.

- 1. The contractor shall perform with its own organization contract work amounting to not less than 30 percent (or a greater percentage if specified elsewhere in the contract) of the total original contract price, excluding any specialty items designated by the contracting agency. Specialty items may be performed by subcontract and the amount of any such specialty items performed may be deducted from the total original contract price before computing the amount of work required to be performed by the contractor's own organization (23 CFR 635.116).
 - a. The term "perform work with its own organization" refers to workers employed or leased by the prime contractor, and equipment owned or rented by the prime contractor, with or without operators. Such term does not include employees or equipment of a subcontractor or lower tier subcontractor, agents of the prime contractor, or any other assignees. The term may include payments for the costs of hiring leased employees from an employee leasing firm meeting all relevant Federal and State regulatory requirements. Leased employees may only be included in this term if the prime contractor meets all of the following conditions:
 - (1) the prime contractor maintains control over the supervision of the day-to-day activities of the leased employees;
 - (2) the prime contractor remains responsible for the quality of the work of the leased employees;
 - (3) the prime contractor retains all power to accept or exclude individual employees from work on the project; and

- (4) the prime contractor remains ultimately responsible for the payment of predetermined minimum wages, the submission of payrolls, statements of compliance and all other Federal regulatory requirements.
- b. "Specialty Items" shall be construed to be limited to work that requires highly specialized knowledge, abilities, or equipment not ordinarily available in the type of contracting organizations qualified and expected to bid or propose on the contract as a whole and in general are to be limited to minor components of the overall contract.
2. The contract amount upon which the requirements set forth in paragraph (1) of Section VI is computed includes the cost of material and manufactured products which are to be purchased or produced by the contractor under the contract provisions.
 3. The contractor shall furnish (a) a competent superintendent or supervisor who is employed by the firm, has full authority to direct performance of the work in accordance with the contract requirements, and is in charge of all construction operations (regardless of who performs the work) and (b) such other of its own organizational resources (supervision, management, and engineering services) as the contracting officer determines is necessary to assure the performance of the contract.
 4. No portion of the contract shall be sublet, assigned or otherwise disposed of except with the written consent of the contracting officer, or authorized representative, and such consent when given shall not be construed to relieve the contractor of any responsibility for the fulfillment of the contract. Written consent will be given only after the contracting agency has assured that each subcontract is evidenced in writing and that it contains all pertinent provisions and requirements of the prime contract.
 5. The 30% self-performance requirement of paragraph (1) is not applicable to design-build contracts; however, contracting agencies may establish their own self-performance requirements.

VII. SAFETY: ACCIDENT PREVENTION

This provision is applicable to all Federal-aid construction contracts and to all related subcontracts.

1. In the performance of this contract the contractor shall comply with all applicable Federal, State, and local laws governing safety, health, and sanitation (23 CFR 635). The contractor shall provide all safeguards, safety devices and protective equipment and take any other needed actions as it determines, or as the contracting officer may determine, to be reasonably necessary to protect the life and health of employees on the job and the safety of the public and to protect property in connection with the performance of the work covered by the contract.
2. It is a condition of this contract, and shall be made a condition of each subcontract, which the contractor enters into pursuant to this contract, that the contractor and any subcontractor shall not permit any employee, in performance of the contract, to work in surroundings or under conditions which are unsanitary, hazardous or dangerous to his/her health or safety, as determined under construction safety and health standards (29 CFR 1926) promulgated by the Secretary of Labor, in accordance with Section 107 of the Contract Work Hours and Safety Standards Act (40 U.S.C. 3704).
3. Pursuant to 29 CFR 1926.3, it is a condition of this contract that the Secretary of Labor or authorized representative thereof, shall have right of entry to any site of contract performance to inspect or investigate the matter of compliance with the construction safety and health standards and to carry out the duties of the Secretary under Section 107 of the Contract Work Hours and Safety Standards Act (40 U.S.C.3704).

VIII. FALSE STATEMENTS CONCERNING HIGHWAY PROJECTS

This provision is applicable to all Federal-aid construction contracts and to all related subcontracts.

In order to assure high quality and durable construction in conformity with approved plans and specifications and a high degree of reliability on statements and representations made by engineers, contractors, suppliers, and workers on Federal-aid highway projects, it is essential that all persons concerned with the project perform their functions as carefully, thoroughly, and honestly as possible. Willful falsification, distortion, or misrepresentation with respect to any facts related to the project is a violation of Federal law. To prevent any misunderstanding regarding the seriousness of these and similar acts, Form FHWA-1022 shall be posted on each Federal-aid highway project (23 CFR 635) in one or more places where it is readily available to all persons concerned with the project:

18 U.S.C. 1020 reads as follows:

"Whoever, being an officer, agent, or employee of the United States, or of any State or Territory, or whoever, whether a person, association, firm, or corporation, knowingly makes any false statement, false representation, or false report as to the character, quality, quantity, or cost of the material used or to be used, or the quantity or quality of the work performed or to be performed, or the cost thereof in connection with the submission of plans, maps, specifications, contracts, or costs of construction on any highway or related project submitted for approval to the Secretary of Transportation; or

Whoever knowingly makes any false statement, false representation, false report or false claim with respect to the character, quality, quantity, or cost of any work performed or to be performed, or materials furnished or to be furnished, in connection with the construction of any highway or related project approved by the Secretary of Transportation; or

Whoever knowingly makes any false statement or false representation as to material fact in any statement, certificate, or report submitted pursuant to provisions of the Federal-aid Roads Act approved July 1, 1916, (39 Stat. 355), as amended and supplemented;

Shall be fined under this title or imprisoned not more than 5 years or both."

IX. IMPLEMENTATION OF CLEAN AIR ACT AND FEDERAL WATER POLLUTION CONTROL ACT

This provision is applicable to all Federal-aid construction contracts and to all related subcontracts.

By submission of this bid/proposal or the execution of this contract, or subcontract, as appropriate, the bidder, proposer, Federal-aid construction contractor, or subcontractor, as appropriate, will be deemed to have stipulated as follows:

1. That any person who is or will be utilized in the performance of this contract is not prohibited from receiving an award due to a violation of Section 508 of the Clean Water Act or Section 306 of the Clean Air Act.
2. That the contractor agrees to include or cause to be included the requirements of paragraph (1) of this Section X in every subcontract, and further agrees to take such action as the contracting agency may direct as a means of enforcing such requirements.

X. CERTIFICATION REGARDING DEBARMENT, SUSPENSION, INELIGIBILITY AND VOLUNTARY EXCLUSION

This provision is applicable to all Federal-aid construction contracts, design-build contracts, subcontracts, lower-tier subcontracts, purchase orders, lease agreements, consultant contracts or any other covered transaction requiring FHWA approval or that is estimated to cost \$25,000 or more – as defined in 2 CFR Parts 180 and 1200.

1. Instructions for Certification – First Tier Participants:

- a. By signing and submitting this proposal, the prospective first tier participant is providing the certification set out below.
- b. The inability of a person to provide the certification set out below will not necessarily result in denial of participation in this covered transaction. The prospective first tier participant shall submit an explanation of why it cannot provide the certification set out below. The certification or explanation will be considered in connection with the department or agency's determination whether to enter into this transaction. However, failure of the prospective first tier participant to furnish a certification or an explanation shall disqualify such a person from participation in this transaction.
- c. The certification in this clause is a material representation of fact upon which reliance was placed when the contracting agency determined to enter into this transaction. If it is later determined that the prospective participant knowingly rendered an erroneous certification, in addition to other remedies available to the Federal Government, the contracting agency may terminate this transaction for cause of default.
- d. The prospective first tier participant shall provide immediate written notice to the contracting agency to whom this proposal is submitted if any time the prospective first tier participant learns that its certification was erroneous when submitted or has become erroneous by reason of changed circumstances.
- e. The terms "covered transaction," "debarred," "suspended," "ineligible," "participant," "person," "principal," and "voluntarily excluded," as used in this clause, are defined in 2 CFR Parts 180 and 1200. "First Tier Covered Transactions" refers to any covered transaction between a grantee or subgrantee of Federal funds and a participant (such as the prime or general contractor). "Lower Tier Covered Transactions" refers to any covered transaction under a First Tier Covered Transaction (such as subcontracts). "First Tier Participant" refers to the participant who has entered into a covered transaction with a grantee or subgrantee of Federal funds (such as the prime or general contractor). "Lower Tier Participant" refers any participant who has entered into a covered transaction with a First Tier Participant or other Lower Tier Participants (such as subcontractors and suppliers).
- f. The prospective first tier participant agrees by submitting this proposal that, should the proposed covered transaction be entered into, it shall not knowingly enter into any lower tier covered transaction with a person who is debarred, suspended, declared ineligible, or voluntarily excluded from participation in this covered transaction, unless authorized by the department or agency entering into this transaction.
- g. The prospective first tier participant further agrees by submitting this proposal that it will include the clause titled "Certification Regarding Debarment, Suspension, Ineligibility and Voluntary Exclusion-Lower Tier Covered Transactions," provided by the department or contracting agency, entering into this covered transaction, without modification, in all lower tier covered transactions and in all solicitations for lower tier covered transactions exceeding the \$25,000 threshold.
- h. A participant in a covered transaction may rely upon a certification of a prospective participant in a lower tier covered transaction that is not debarred, suspended, ineligible, or voluntarily excluded from the covered transaction, unless it knows that the certification is erroneous. A participant is responsible for ensuring that its principals are not suspended, debarred, or otherwise ineligible to participate in covered transactions. To verify the eligibility of its principals, as well as the eligibility of any lower tier prospective participants, each participant may, but is not required to, check the Excluded Parties List System website (<https://www.epls.gov/>), which is compiled by the General Services Administration.
- i. Nothing contained in the foregoing shall be construed to require the establishment of a system of records in order to render in good faith the certification required by this clause. The knowledge and information of the prospective participant is not required to exceed that which is normally possessed by a prudent person in the ordinary course of business dealings.
- j. Except for transactions authorized under paragraph (f) of these instructions, if a participant in a covered transaction knowingly enters into a lower tier covered transaction with a person who is suspended, debarred, ineligible, or voluntarily excluded from participation in this transaction, in addition to other remedies available to the Federal Government, the department or agency may terminate this transaction for cause or default.

* * * * *

2. Certification Regarding Debarment, Suspension, Ineligibility and Voluntary Exclusion – First Tier Participants:

- a. The prospective first tier participant certifies to the best of its knowledge and belief, that it and its principals:
 - (1) Are not presently debarred, suspended, proposed for debarment, declared ineligible, or voluntarily excluded from participating in covered transactions by any Federal department or agency;
 - (2) Have not within a three-year period preceding this proposal been convicted of or had a civil judgment rendered against them for commission of fraud or a criminal offense in connection with obtaining, attempting to obtain, or performing a public (Federal, State or local) transaction or contract under a public transaction; violation of Federal or State antitrust statutes or commission of embezzlement, theft, forgery, bribery, falsification or destruction of records, making false statements, or receiving stolen property;
 - (3) Are not presently indicted for or otherwise criminally or civilly charged by a governmental entity (Federal, State or local) with commission of any of the offenses enumerated in paragraph (a)(2) of this certification; and
 - (4) Have not within a three-year period preceding this application/proposal had one or more public transactions (Federal, State or local) terminated for cause or default.
- b. Where the prospective participant is unable to certify to any of the statements in this certification, such prospective participant shall attach an explanation to this proposal.

2. Instructions for Certification - Lower Tier Participants:

(Applicable to all subcontracts, purchase orders and other lower tier transactions requiring prior FHWA approval or estimated to cost \$25,000 or more - 2 CFR Parts 180 and 1200)

- a. By signing and submitting this proposal, the prospective lower tier is providing the certification set out below.
- b. The certification in this clause is a material representation of fact upon which reliance was placed when this transaction was entered into. If it is later determined that the prospective lower tier participant knowingly rendered an erroneous certification, in addition to other remedies available to the Federal Government, the department, or agency with which this transaction originated may pursue available remedies, including suspension and/or debarment.
- c. The prospective lower tier participant shall provide immediate written notice to the person to which this proposal is submitted if at any time the prospective lower tier participant learns that its certification was erroneous by reason of changed circumstances.
- d. The terms "covered transaction," "debarred," "suspended," "ineligible," "participant," "person," "principal," and "voluntarily excluded," as used in this clause, are defined in 2 CFR Parts 180 and 1200. You may contact the person to which this proposal is submitted for assistance in obtaining a copy of those regulations. "First Tier Covered Transactions" refers to any covered transaction between a grantee or subgrantee of

Federal funds and a participant (such as the prime or general contract). "Lower Tier Covered Transactions" refers to any covered transaction under a First Tier Covered Transaction (such as subcontracts). "First Tier Participant" refers to the participant who has entered into a covered transaction with a grantee or subgrantee of Federal funds (such as the prime or general contractor). "Lower Tier Participant" refers any participant who has entered into a covered transaction with a First Tier Participant or other Lower Tier Participants (such as subcontractors and suppliers).

- e. The prospective lower tier participant agrees by submitting this proposal that, should the proposed covered transaction be entered into, it shall not knowingly enter into any lower tier covered transaction with a person who is debarred, suspended, declared ineligible, or voluntarily excluded from participation in this covered transaction, unless authorized by the department or agency with which this transaction originated.
- f. The prospective lower tier participant further agrees by submitting this proposal that it will include this clause titled "Certification Regarding Debarment, Suspension, Ineligibility and Voluntary Exclusion-Lower Tier Covered Transaction," without modification, in all lower tier covered transactions and in all solicitations for lower tier covered transactions exceeding the \$25,000 threshold.
- g. A participant in a covered transaction may rely upon a certification of a prospective participant in a lower tier covered transaction that is not debarred, suspended, ineligible, or voluntarily excluded from the covered transaction, unless it knows that the certification is erroneous. A participant is responsible for ensuring that its principals are not suspended, debarred, or otherwise ineligible to participate in covered transactions. To verify the eligibility of its principals, as well as the eligibility of any lower tier prospective participants, each participant may, but is not required to, check the Excluded Parties List System website (<https://www.epls.gov/>), which is compiled by the General Services Administration.
- h. Nothing contained in the foregoing shall be construed to require establishment of a system of records in order to render in good faith the certification required by this clause. The knowledge and information of participant is not required to exceed that which is normally possessed by a prudent person in the ordinary course of business dealings.
- i. Except for transactions authorized under paragraph e of these instructions, if a participant in a covered transaction knowingly enters into a lower tier covered transaction with a person who is suspended, debarred, ineligible, or voluntarily excluded from participation in this transaction, in addition to other remedies available to the Federal Government, the department or agency with which this transaction originated may pursue available remedies, including suspension and/or debarment.

* * * * *

Certification Regarding Debarment, Suspension, Ineligibility and Voluntary Exclusion--Lower Tier Participants:

1. The prospective lower tier participant certifies, by submission of this proposal, that neither it nor its principals is presently debarred, suspended, proposed for debarment, declared ineligible, or voluntarily excluded from participating in covered transactions by any Federal department or agency.
2. Where the prospective lower tier participant is unable to certify to any of the statements in this certification, such prospective participant shall attach an explanation to this proposal.

* * * * *

XI. CERTIFICATION REGARDING USE OF CONTRACT FUNDS FOR LOBBYING

This provision is applicable to all Federal-aid construction contracts and to all related subcontracts which exceed \$100,000 (49 CFR 20).

1. The prospective participant certifies, by signing and submitting this bid or proposal, to the best of his or her knowledge and belief, that:
 - a. No Federal appropriated funds have been paid or will be paid, by or on behalf of the undersigned, to any person for influencing or attempting to influence an officer or employee of any Federal agency, a Member of Congress, an officer or employee of Congress, or an employee of a Member of Congress in connection with the awarding of any Federal contract, the making of any Federal grant, the making of any Federal loan, the entering into of any cooperative agreement, and the extension, continuation, renewal, amendment, or modification of any Federal contract, grant, loan, or cooperative agreement.
 - b. If any funds other than Federal appropriated funds have been paid or will be paid to any person for influencing or attempting to influence an officer or employee of any Federal agency, a Member of Congress, an officer or employee of Congress, or an employee of a Member of Congress in connection with this Federal contract, grant, loan, or cooperative agreement, the undersigned shall complete and submit Standard Form-LLL, "Disclosure Form to Report Lobbying," in accordance with its instructions.
2. This certification is a material representation of fact upon which reliance was placed when this transaction was made or entered into. Submission of this certification is a prerequisite for making or entering into this transaction imposed by 31 U.S.C. 1352. Any person who fails to file the required certification shall be subject to a civil penalty of not less than \$10,000 and not more than \$100,000 for each such failure.
3. The prospective participant also agrees by submitting its bid or proposal that the participant shall require that the language of this certification be included in all lower tier subcontracts, which exceed \$100,000 and that all such recipients shall certify and disclose accordingly.

STANDARD SPECIAL PROVISION
MINIMUM WAGES
GENERAL DECISION NC140092 01/03/2014 NC92

Z-92

Date: January 3, 2014

General Decision Number: NC140092 01/03/2014 NC92

Superseded General Decision Numbers: NC20130092

State: North Carolina

Construction Type: HIGHWAY

COUNTIES:

Guilford	Randolph	Rockingham
----------	----------	------------

HIGHWAY CONSTRUCTION PROJECTS (excluding tunnels, building structures in rest area projects, railroad construction, bascule, suspension and spandrel arch bridges designed for commercial navigation, bridges involving marine construction, and other major bridges).

Modification Number
0

Publication Date
01/03/2014

SUNC2011-073 09/16/2011

	Rates	Fringes
CARPENTER (Form Work Only)		
Guilford County	13.37	
Randolph and Rockingham Counties	13.03	
CEMENT MASON/CONCRETE FINISHER		
Guilford and Rockingham Counties	13.73	
Randolph County	13.57	
IRONWORKER (Reinforcing)	14.88	
LABORER		
Asphalt, Asphalt Distributor, Raker, and Spreader	12.02	
Common or General		
Guilford County	10.67	
Randolph County	10.20	
Rockingham County	10.73	
Concrete Saw	13.52	
Landscape	9.65	
Luteman	12.73	
Mason Tender (Cement/Concrete)	11.43	
Pipelayer		
Guilford County	12.86	
Randolph and Rockingham Counties	12.76	
Traffic Control (Cone Setter)	12.25	
Traffic Control (Flagger)	8.93	

	Rates	Fringes
POWER EQUIPMENT OPERATORS		
Backhoe/Excavator/Trackhoe		
Guilford County	15.18	
Randolph County	15.04	
Rockingham County	14.96	
Broom/Sweeper	14.82	
Bulldozer	14.00	
Crane		
Guilford County	17.88	
Randolph and Rockingham Counties	17.53	
Curb Machine	14.43	
Distributor	15.27	
Drill	18.28	
Grader/Blade	14.00	
Loader		
Guilford and Rockingham Counties	14.33	
Randolph County	14.11	
Mechanic		
Guilford County	12.44	
Randolph and Rockingham Counties	12.73	
Milling Machine		
Guilford and Rockingham Counties	14.38	
Randolph County	14.05	
Oiler	13.58	
Paver	16.00	
Roller		
Guilford County	13.04	
Randolph County	12.80	
Rockingham County	13.12	
Scraper	14.00	
Screed	15.18	
Tractor	12.94	
TRUCK DRIVER		
4 Axle Truck		
Guilford County	13.81	
Randolph and Rockingham Counties	13.78	
Distributor	16.75	
Dump Truck		
Guilford County	12.57	
Randolph County	11.91	
Rockingham County	12.17	
Flatbed Truck	15.02	
Lowboy Truck	15.34	
Off the Road Truck	13.78	
Single Axle Truck	13.40	
Tack Truck	16.51	
Water Truck	13.03	

Welders – Receive rate prescribed for craft performing operation to which welding is incidental.

Unlisted classifications needed for work not included within the scope of the classifications listed may be added after award only as provided in the labor standards contract clauses (29 CFR 5.5(a)(1)(ii)).

The body of each wage determination lists the classification and wage rates that have been found to be prevailing for the cited type(s) of construction in the area covered by the wage determination. The classifications are listed in alphabetical order of "identifiers" that indicate whether the particular rate is union or non-union.

Union Identifiers

An identifier enclosed in dotted lines beginning with characters other than "SU" denotes that the union classification and rate have found to be prevailing for that classification. Example: PLUM0198-005 07/01/2011. The first four letters , PLUM, indicate the international union and the four-digit number, 0198, that follows indicates the local union number or district council number where applicable, i.e., Plumbers Local 0198. The next number, 005 in the example, is an internal number used in processing the wage determination. The date, 07/01/2011, following these characters is the effective date of the most current negotiated rate/collective bargaining agreement which would be July 1, 2011 in the above example.

Union prevailing wage rates will be updated to reflect any changes in the collective bargaining agreements governing the rates.

0000/9999: weighted union wage rates will be published annually each January.

Non-Union Identifiers

Classifications listed under an "SU" identifier were derived from survey data by computing average rates and are not union rates; however, the data used in computing these rates may include both union and non-union data. Example: SULA2004-007 5/13/2010. SU indicates the rates are not union rates, LA indicates the State of Louisiana; 2004 is the year of the survey; and 007 is an internal number used in producing the wage determination. A 1993 or later date, 5/13/2010, indicates the classifications and rates under that identifier were issued as a General Wage Determination on that date.

Survey wage rates will remain in effect and will not change until a new survey is conducted.

WAGE DETERMINATION APPEALS PROCESS

- 1.) Has there been an initial decision in the matter? This can be:
 - * an existing published wage determination
 - * a survey underlying a wage determination
 - * a Wage and Hour Division letter setting forth a position on a wage determination matter
 - * a conformance (additional classification and rate) ruling

On survey related matters, initial contact, including requests for summaries of surveys, should be with the Wage and Hour Regional Office for the area in which the survey was conducted because those Regional Offices have responsibility for the Davis-Bacon survey program. If the response from this initial contact is not satisfactory, then the process described in 2.) and 3.) should be followed.

With regard to any other matter not yet ripe for the formal process described here, initial contact should be with the Branch of Construction Wage Determinations. Write to:

Branch of Construction Wage Determinations
Wage and Hour Division
U. S. Department of Labor
200 Constitution Avenue, N.W.
Washington, D.C. 20210

2.) If the answer to the question in 1.) is yes, then an interested party (those affected by the action) can request review and reconsideration from the Wage and Hour Administrator (See 29 CFR Part 1.8 and 29 CFR Part 7). Write to:

Wage and Hour Administrator
U.S. Department of Labor
200 Constitution Avenue, N.W.
Washington, D.C. 20210

The request should be accompanied by a full statement of the interested party's position and by any information (wage payment data, project description, area practice material, etc.) that the requestor considers relevant to the issue.

3.) If the decision of the Administrator is not favorable, an interested party may appeal directly to the Administrative Review Board (formerly the Wage Appeals Board). Write to:

Administrative Review Board
U.S. Department of Labor
200 Constitution Avenue, N.W.
Washington, D.C. 20210

4.) All decisions by the Administrative Review Board are final.

END OF GENERAL DECISION

***** STANDARD SPECIAL PROVISIONS *****

(7-9-12)

DIVISION ONE OF STANDARD SPECIFICATIONS

Division One of the 2012 NCDOT Standard Specifications for Roads and Structures (Standard Specifications) shall apply except as follows:

Definitions: Throughout Division One of the *Standard Specifications*, the term “Contractor” is replaced with “Design-Build Team”, the term “Bidder” is replaced with “Proposer,” the term “Bid” is replaced by “Price Proposal,” and the phrase “lowest Responsible Bidder” is replaced with “responsible Proposer with the lowest adjusted price.” The replacement of “Contractor” with “Design-Build Team” does not apply to Article 102-2. The replacement of the above terms also does not apply when the terms are part of a phrase (e.g. bid bond, prime contractor, total amount bid, etc.)

Deletions: Articles 102-4, 102-8(B), 102-9(C)(2), 103-2(B), and 103-4(B) of the *Standard Specifications* are deleted from Design-Build Contracts.

Modifications: The remainder of this Standard Special Provision includes modifications to Division One of the *Standard Specifications*.

**SECTION 101
DEFINITION OF TERMS**

Page 1-3, Article 101-3, replace and add certain definitions as follows:

ADDITIONAL WORK

Additional work is that which results from a change or alteration to the contract and for which there are contract unit prices in the original contract or an executed supplemental agreement.

ADVERTISEMENT

The public advertisement inviting Statements of Qualifications for the design and construction of specific projects.

AWARD

The decision of the Department of Transportation to accept the proposal of the selected Design-Build Team for work which is subject to the furnishing of payment and performance bonds, and such other conditions as may be otherwise provided by law, the Request for Proposals, and the *Standard Specifications*.

CONTRACT

The executed agreement between the Department and the successful proposer, covering the performance of, and compensation for, the work. The term contract is all inclusive with reference to all written agreements affecting a contractual relationship and all documents referred to therein. The contract shall include, but not be limited to, the Request for Proposals, the

Technical Proposal, the Price Proposal, the printed contract form and attachments, contract bonds, plans and associated special provisions prepared by the Design-Build Team, standard specifications and supplemental specifications standard special provisions and project special provisions contained in the Request for Proposals or as developed by the Design-Build Team and accepted by the Department, and all executed supplemental agreements. The contract shall constitute one instrument.

DATE OF AVAILABILITY

That date set forth in the Request for Proposals, by which it is anticipated that the Contract will be executed and sufficient design efforts or work sites within the project limits will be available for the Design-Build Team to begin his controlling operations or design.

DESIGN-BUILD

A form of contracting in which the successful proposer undertakes responsibility for both the design and construction of a project.

DESIGN-BUILD TEAM

An individual, partnership, joint venture, corporation or other legal entity that furnishes the necessary design and construction services, whether by itself or through subcontracts.

DESIGN-BUILD PROPOSAL

A proposal to contract consisting of a separately sealed Technical Proposal and a separately sealed Price Proposal submitted in response to a Request for Proposals on a Design-Build project.

PLANS

The project plans, Standard Drawings, working drawings and supplemental drawings, or reproductions thereof, accepted by the Engineer, which show the location, character, dimensions and details of the work to be performed. Unless otherwise noted within the Request for Proposals, the term "plans" refers to plans as developed by the Design-Build Team and accepted by the Department.

(A) Standard Drawings:

Drawings approved for repetitive use, showing details to be used where appropriate. All Standard Drawings approved by the Department plus subsequent revisions and additions. Standard Drawings are available for purchase from:

Randy A. Garris, PE
State Contract Officer
1591 Mail Service Center
Raleigh, NC 27699-1591

(B) Preliminary Plans:

Department-furnished drawings distributed in concert with a Request for Proposals, or as developed by the Design-Build Team.

(C) **Project Plans:**

Construction drawings prepared, sealed and completed by the Design-Build Team, or as provided by the Department, that contain specific details and dimensions peculiar to the work.

(D) **Working Drawings and Supplemental Drawings:**

Supplemental design sheets, shop drawings, or similar data which the Design-Build Team is required to submit to the Engineer.

(E) **As-Constructed Drawings:**

Final drawings prepared by the Design-Build Team, documenting the details and dimensions of the completed work.

PRICE PROPOSAL

The offer of a Proposer, submitted on the prescribed forms, to perform the work and furnish the labor and materials at the price quoted.

PROPOSAL (OR REQUEST FOR PROPOSALS)

The paper document provided by the Department that the proposer uses to develop his paper offer to perform the work at designated bid prices.

PROPOSER

An individual, partnership, firm, corporation, LLC, or joint venture formally submitting a Technical Proposal and Price Proposal in response to a Request for Proposals.

RIGHT OF WAY

The land area shown on the plans as right of way within which the project is to be constructed.

SCHEDULE OF VALUES

A schedule of work items necessary to complete work, along with the progress of each work item, primarily for the purpose of partial payments.

TABLE OF QUANTITIES

A listing of work items (corresponding to the items in the Trns*port pay item list) that contributes to a project completion. The table shall include estimated quantities for each work item.

TECHNICAL PROPOSAL

A submittal from a proposer, in accordance with requirements of the Request for Proposals, for the purpose of final selection. The Technical Proposal is defined to also include any supplemental information requested by the Department from a proposer prior to opening bids.

SECTION 102 PROPOSAL REQUIREMENTS AND CONDITIONS

Page 1-9, delete Article 102-1 and replace with the following:

102-1 INVITATION TO BID

After the advertisement has been made, an Invitation to Bid will be made available to known prequalified contractors and any other contracting firms, material suppliers and other interested parties who have requested they be placed on the Invitation to Bid mailing list, informing them that Statements of Qualifications and Proposals will be received for the construction of specific projects. Such invitation will indicate the contract identification number, length, locations and descriptions; a general summary of the scope of work to be performed; and information on how to receive a Request for Qualifications.

All projects will be advertised in daily newspapers throughout the state before the bid opening.

Page 1-12, delete Article 102-3 and replace with the following:

102-3 CONTENTS OF REQUEST FOR PROPOSALS

A Request for Proposals will be furnished by the Department to the selected proposers from among the respondents to the Request for Qualifications. Each Request for Proposals will be marked on the front cover by the Department with an identifier of the Proposer to whom it is being furnished. This Request for Proposals will state the location of the project and will show a schedule of contract items for which Technical and Price Proposals are invited. It will set forth the date and time Technical and Price Proposals are to be submitted and when the Price Proposals will be opened. The Request for Proposals will also include special provisions or requirements that vary from or are not contained in any preliminary design information or standard specifications.

The Request for Proposals will also include the printed contract forms and signature sheets for execution by both parties to the contract. In the event the Proposer is awarded the contract, execution of the Request for Proposals by the Proposer is considered the same as execution of the contract.

Standard specifications, sealed plans specifically identified as the Department's responsibility and other documents designated in the Request for Proposals shall be considered a part of the Request for Proposals whether or not they are attached thereto. All papers bound with the proposal are necessary parts thereof and shall not be detached, taken apart, or altered.

The names and identity of each prospective Proposer that receives a copy of the Request for Qualifications for the purposes of submitting a Statement of Qualifications shall be made public, except that a potential Proposer who obtains a Request for Qualifications may, at the time of ordering, request that his name remain confidential.

One copy of the Final Request for Proposals will be furnished to each prospective Proposer. Additional copies may be purchased for the sum of \$25 each. The copy of the Final Request for

Proposals marked with the Proposer's name and prequalification number shall be returned to the Department as the Proposer's Price Proposal.

Page 1-14, Article 102-7, 4th paragraph, delete the first two sentences and replace with the following:

The Proposer is cautioned that details shown in the subsurface investigation report are preliminary only. The subsurface investigation and subsurface report, if provided, is done so for information purposes only.

Pages 1-14, delete Article 102-8 and replace with the following:

102-8 PREPARATION AND SUBMISSION OF BIDS

All Price Proposals shall be prepared and submitted in accordance with the following requirements:

1. The Request for Proposals provided by the Department shall be used and shall not be taken apart or altered. The Price Proposal shall be submitted on the same form, which has been furnished to the Proposer by the Department as identified by the Proposer's name marked on the front cover by the Department.
2. All entries including signatures shall be written in ink.
3. The Proposer shall submit a lump sum or unit price for every item in the Price Proposal. The lump sum or unit prices bid for the various contract items shall be written in figures.
4. An amount bid shall be entered in the Request for Proposals for every item and the price shall be written in figures in the "Amount Bid" column in the Request for Proposals.
5. An amount bid shall be entered in the proposal for every item on which a unit price has been submitted. The amount bid for each item other than lump sum items shall be determined by multiplying each unit bid price by the quantity for that item and shall be written in figures in the Amount Bid column in the proposal.
6. The total amount bid shall be written in figures in the proper place in the Request for Proposals. The total amount bid shall be determined by adding the amounts bid for each lump sum item.
7. Changes in any entry shall be made by marking through the entry in ink and making the correct entry adjacent thereto in ink. A representative of the Proposer shall initial the change in ink.
8. The Price Proposal shall be properly executed. To constitute proper execution, the Price Proposal shall be executed in strict compliance with the following:
 - a. If a Price Proposal is by an individual, it shall show the name of the individual and shall be signed by the individual with the word "Individually" appearing under the signature. If the individual operates under a firm name, the bid shall be signed in the name of the individual doing business under the firm name.
 - b. If the Price Proposal is by a corporation, it shall be executed in the name of the corporation by the President, Vice President, or Assistant Vice President. It shall be

- attested by the Secretary or Assistant Secretary. The seal of the corporation shall be affixed. If the Price Proposal is executed on behalf of a corporation in any other manner than as above, a certified copy of the minutes of the Board of Directors of said corporation authorizing the manner and style of execution and the authority of the person executing shall be attached to the Price Proposal or shall be on file with the Department.
- c. If the Price Proposal is made by a partnership, it shall be executed in the name of the partnership by one of the general partners.
 - d. If the Price Proposal is made by a limited liability company, it shall be signed by the manager, member, or authorized agent and notarized.
 - e. If the Price Proposal is made by a joint venture, it shall be executed by each of the joint venturers in the appropriate manner set out above. In addition, the execution by the joint venturers shall appear below their names.
 - f. The Price Proposal execution shall be notarized by a notary public whose commission is in effect on the date of execution. Such notarization shall be applicable both to the Price Proposal and to the Non-Collusion Affidavit, Debarment Certification and Gift Ban Certification that is part of the signature sheets.
9. The Price Proposal shall not contain any unauthorized additions, deletions, or conditional bids.
 10. The Proposer shall not add any provision reserving the right to accept or reject an award or to enter into a contract pursuant to an award.
 11. The Price Proposal shall be accompanied by a bid bond on the form furnished by the Department or by a bid deposit. The bid bond shall be completely and properly executed in accordance with the requirements of Article 102-10 and as modified herein. The bid deposit shall be a certified check or cashier check in accordance with Article 102-10 and as modified herein.
 12. The Price Proposal shall be placed in a sealed envelope and shall have been delivered to and received by the Department prior to the time specified in the Request for Proposals.

Page 1-18, Article 102-10, 3rd paragraph, delete the fifth sentence and replace with the following:

The condition of the bid bond or bid deposit is: the Principal shall not withdraw its bid within 75 days after the submittal of the same, and if the Department shall award a contract to the Principal, the Principal shall within 14 calendar days after the notice of award is received by him, give payment and performance bonds with good and sufficient surety as required for the faithful performance of the contract and for the protection of all persons supplying labor and materials in the prosecution of the work.

Page 1-18, Article 102-10, delete the end of the Article beginning with, and inclusive of, the 6th paragraph.

Pages 1-19, delete Article 102-12 and replace with the following:

102-12 WITHDRAWAL OR REVISION OF BIDS

A Design-Build Team will not be permitted to withdraw its Technical and Price Proposals after they have been submitted to the Department, unless allowed under Article 103-3 or unless otherwise approved by the Chief Engineer.

Page 1-19, delete Article 102-13 and replace with the following:

102-13 RECEIPT AND OPENING OF BIDS

Price Proposals from shortlisted Proposers will be opened and read publicly on the date and time indicated in the Request for Proposals. The scores of the previously conducted evaluation of the Technical Proposals will also be read publicly in accordance with the procedures outlined in the Request for Proposals. Proposers, their authorized agents, and other interested parties are invited to be present.

Page 1-19, Article 102-14, replace the 1st paragraph with the following:

102-14 REJECTION OF BIDS

Any Price Proposal submitted which fails to comply with any of the requirements of Articles 102-8, 102-9 or 102-10, or with the requirements of the project scope and specifications shall be considered irregular and may be rejected. A Price Proposal that does not contain costs for all proposal items shall be considered irregular and may be rejected.

Page 1-20, Subarticle 102-15(O), delete and replace with the following:

(O) Failure to restrict a former Department employee as prohibited by Article 108-5.

SECTION 103 AWARD AND EXECUTION OF CONTRACT

Page 1-21, delete Article 103-1 and replace with the following:

103-1 CONSIDERATION OF PRICE PROPOSALS

After the Price Proposals are opened and read, they will be tabulated. The Price Proposal and score of the Technical Proposal will be made available in accordance with procedures outlined in the Request for Proposals. In the event of errors, omissions, or discrepancies in the bid prices, corrections to the Price Proposal will be made in accordance with the provisions of Article 103-2. Such corrected bid prices will be used to determine the lowest adjusted price.

After the reading of the Price Proposals and technical scores, the Department will calculate the lowest adjusted price as described in the Request for Proposals.

The right is reserved to reject any or all Price Proposals, to waive technicalities, to request the Proposer with the lowest adjusted price to submit an up-to-date financial and operating statement, to advertise for new proposals, or to proceed to do the work otherwise, if in the judgment of the Department, the best interests of the State will be promoted thereby.

Page 1-21, Subarticle 103-2(A), add items (6) and (7) as follows:

- (6) **Discrepancy in the “Total Amount Bid” and the addition of the “Amount Bid” for each line Item**

In the case of the Total Amount Bid does not equal the summation of each Amount Bid for the line items, the summation of each Amount Bid for the line items shall be deemed to be the correct Total Amount Bid for the entire project.

- (7) **Omitted Total Amount Bid –Amount Bid Completed**

If the Total Amount Bid is not completed and the Amount Bid for all line items is completed the Total Amount Bid shall be the summation of the Amount Bid for all line items.

Page 1-24, Subarticle 103-4(A), first paragraph, replace the 4th and 5th sentences with the following:

Where award is to be made, the notice of award will be issued within 75 days after the submittal of Price Proposals, except with the consent of the responsible Proposer with the lowest adjusted price the decision to award the contract to such bidder may be delayed for as long a time as may be agreed upon by the Department and such Proposer. In the absence of such agreement, the Proposer may withdraw his Price Proposal at the expiration of the 75 days without penalty if no notice of award has been issued.

Page 1-25, Article 103-6, delete the 1st and 2nd paragraphs and replace with the following:

Checks that have been furnished as a bid deposit will be retained until after the contract bonds have been furnished by the successful proposer, at which time the checks that were furnished as a bid deposit will be returned.

SECTION 104 SCOPE OF WORK

Page 1-26, delete Article 104-1 and replace with the following:

104-1 INTENT OF CONTRACT

The intent of the contract is to prescribe the work or improvements that the Design-Build Team undertakes to perform, in full compliance with the contract documents. In case the method of construction or character of any part of the work is not covered by the contract, this section shall apply. The Design-Build Team shall perform all work in accordance with the contract or as may be modified by written orders, and shall do such special, additional, extra, and incidental work as may be considered necessary to complete the work to the full intent of the contract. Unless otherwise provided elsewhere in the contract, the Design-Build Team shall furnish all implements, machinery, equipment, tools, materials, supplies, transportation, and labor necessary for the design, prosecution and completion of the work.

Page 1-26, Article 104-3, replace “plans or details of construction” with “contract” in all instances within this Article.

Page 1-35, Article 104-10, replace the first paragraph with the following:

104-10 MAINTENANCE OF THE PROJECT

The Design-Build Team shall maintain the project from the date of beginning construction on the project until the project is finally accepted. For sections of facilities impacted by utility construction / relocation performed by the Design-Build Team prior to beginning construction on the roadway project, maintenance of the impacted sections of facilities shall be performed by the Design-Build Team beginning concurrently with the impact. All existing and constructed guardrail / guiderail within the project limits shall be included in this maintenance. This maintenance shall be continuous and effective and shall be prosecuted with adequate equipment and forces to the end that all work covered by the contract is kept in satisfactory and acceptable conditions at all times. The Design-Build Team shall perform weekly inspections of guardrail and guiderail and shall report damages to the Engineer on the same day of the weekly inspection. Where damaged guardrail or guiderail is repaired or replaced as a result of maintaining the project in accordance with this Article, such repair or replacement shall be performed within 7 consecutive calendar days of such inspection report.

Page 1-35, Article 104-10, add the following after the last paragraph:

The Design-Build Team will not be compensated for performance of weekly inspections and damage reports for the guardrail / guiderail. Other maintenance activities for existing guardrail / guiderail will be handled in accordance with Articles 104-7 and 104-8.

SECTION 105 CONTROL OF WORK

Pages 1-40, delete Article 105-2 and replace with the following:

105-2 PLANS AND WORKING DRAWINGS

All plans shall be supplemented by such approved working drawings as are necessary to adequately control the work. Working drawings furnished by the Design-Build Team and approved by the Engineer shall consist of such detailed drawings as may be required to adequately control the work. They may include stress sheets, shop drawings, erection drawings, falsework drawings, cofferdam drawings, bending diagrams for reinforcing steel, catalog cuts, or any other supplementary drawings or similar data required of the Design-Build Team. When working drawings are approved by the Engineer, such approval shall not operate to relieve the Design-Build Team of any of his responsibility under the contract for the successful completion of the work.

Changes on shop drawings after approval and/or distribution shall be subject to the approval of the Engineer and he shall be furnished a record of such changes.

Page 1-41, Article 105-3, add the following after the 3rd paragraph:

The Design-Build Team shall bear all the costs of providing the burden of proof that the nonconforming work is reasonable and adequately addresses the design purpose. The Design-

Build Team shall bear all risk for continuing with nonconforming work in question until it is accepted.

The Engineer may impose conditions for acceptance of the nonconforming work. The Design-Build Team shall bear all costs for fulfilling the conditions.

The decisions whether the product satisfies the design purpose, whether the nonconforming work is reasonably acceptable and the conditions for acceptance are at the sole discretion of the Engineer.

Pages 1-41, delete Article 105-4 and replace with the following:

105-4 COORDINATION OF PLANS, SPECIFICATIONS, SUPPLEMENTAL SPECIFICATIONS, AND SPECIAL PROVISIONS

The Request for Proposals, all construction Plans, the Standard Specifications, Supplemental Specifications and Special Provisions and all supplementary documents are essential parts of the contract and a requirement occurring in one is as binding as though occurring in all. They are complementary and describe and provide the complete contract.

In case of discrepancy or conflict, the order in which they govern shall be as follows:

- (A) Request for Proposals, in which Project Special Provisions govern Standard Special Provisions
- (B) Technical Proposal from the Design-Build Team
- (C) Accepted Plans and Details from the Design-Build Team, or sealed plans provided by the Department, as applicable
- (D) Standard Drawings
- (E) Standard Specifications

Where dimensions on the plans are given or can be computed from other given dimensions they shall govern over scaled dimensions.

The Design-Build Team shall take no advantage of any error or omission in the plans, estimated quantities, or specifications. In the event the Design-Build Team discovers an error or omission, he shall immediately notify the Engineer.

Page 1-43, Article 105-8, line 28, after the first sentence, add the following:

Identify excavation locations by means of pre-marking with white paint, flags, or stakes or provide a specific written description of the location in the locate request.

Page 1-44, delete Article 105-9 and replace with the following:

105-9 CONSTRUCTION STAKES, LINES, AND GRADES

The Design-Build Team shall be responsible for all surveying, construction staking and layout required in the performance of the work. He will be responsible for the accuracy of lines, slopes, grades and other engineering work which he provides under this contract.

SECTION 106 CONTROL OF MATERIAL

Page 1-49, Article 106-2, add the following after the second paragraph:

Prior to beginning construction, the Design-Build Team shall provide a Table of Quantities as described in Article 101-3 of these specifications.

The Table of Quantities Work Items shall correspond to Pay Items as defined in the Standard Specifications. These Work Items have associated Materials and Conversion Factors. For non-standard Work Items, a Generic Work Item with the correct Unit of Measure and in an appropriate category will be used. For example, “GENERIC TRAFFIC CONTROL ITEM – EA” or “GENERIC RETAINING WALL ITEM – LF”. For these Generic Work Items, Materials must be defined and appropriate conversion factors submitted.

An initial Table of Quantities shall be submitted no later than 30 calendar days after the date of award. The Table of Quantities shall be updated and resubmitted within 14 days of when a set of Plans is sealed as Release for Construction (RFC) Plans, and whenever there are substantial changes to the Quantities on previously incorporated RFC Plans.

Page 1-51, Article 106-6, add the following after the last paragraph:

For items normally pretested by the Department, the Design-Build Team shall provide a minimum of 30 days notice prior to the beginning of production of the items for this project along with final approved shop drawings.

SECTION 107 LEGAL RELATIONS AND RESPONSIBILITY TO PUBLIC

Page 1-61, delete Article 107-18 and replace with the following:

107-18 FURNISHING RIGHT OF WAY

The responsibility for coordinating the securing of all necessary rights of way is as outlined in the Request for Proposals.

SECTION 108 PROSECUTION AND PROGRESS

Page 1-64. Article 108-2, replace the 2nd paragraph with the following:

The Design-Build Team shall submit a Progress Schedule for review within thirty (30) calendar days of receiving Notice of Award. The Department will review the Progress Schedule within twenty-one (21) calendar days of receipt. The Design-Build Team shall make any necessary corrections and adjustments to the Progress Schedule as necessitated by the Department’s review within seven (7) calendar days. The Department will review the revised Progress Schedule within seven (7) calendar days of receipt.

Page 1-64, Subarticle 108-2(A)(1), add the following:

(k) Utility relocation and construction

Page 1-65, Subarticle 108-2(A)(2), add the following:

(h) Critical design submittal dates

(i) Critical permitting dates

(j) Completion of right of way acquisition

(k) Completion of utility relocation and construction

Page 1-65, Article 108-2, add the following:

(D) The Design-Build Team shall provide a written narrative each month detailing the work and percentage of work completed, anticipated sequence of upcoming work (2 month forecast), controlling operation(s), intermediate completion dates, and milestones. If any milestones are exceeded or will not be achieved, the Design-Build Team shall provide in the written narrative details of the delay; controlling operation affected, impacts to other operations, revisions to future intermediate completion dates and milestones, and remedial action necessary to get the project back to the original completion date.

Page 1-65, delete Article 108-3 and replace with the following:

108-3 PRECONSTRUCTION AND PRE-DESIGN CONFERENCES

The selected Design-Build Team shall meet with the Engineer for a pre-design conference concerning the design phase of the work. This conference shall be held prior to the commencement of work, as it is determined according to Article 108-1, and will be scheduled by the Engineer. At the predesign conference, the Design-Build Team shall furnish authorized signature forms and a list of any proposed subcontractors associated with the design of the project.

A preconstruction conference shall be held at least 10 working days before construction activity begins. This second conference, concerning the construction phase, shall also be scheduled by the Engineer. The Design-Build Team shall give the Engineer a minimum of 45 days notice before he plans to begin construction activities. This will allow the Engineer time for any environmental agency representatives involved in the permitting process, as well as any other pertinent entities, to be scheduled to attend the preconstruction conference. If the Design-Build Team is responsible for utilities in accordance with Article 105-8 and the Request for Proposals, he shall be responsible for coordinating with the Engineer in scheduling their attendance and for notifying them. The Design-Build Team shall also be responsible for coordinating with the Engineer in scheduling the attendance of subcontractors and others deemed appropriate, and for notifying them.

At the preconstruction conference, a list of any proposed subcontractors and major material suppliers associated with the construction of the project will be submitted.

If the contract has a DBE requirement, the Design-Build Team shall submit copies of completed and signed DBE subcontracts, purchase orders, or invoices to the Department.

The Design-Build Team shall submit a traffic control plan in accordance with Article 1101-5 and the Request for Proposals. The Design-Build Team shall designate an employee who is competent and experienced in traffic control to implement and monitor the traffic control plan. The qualifications of the designated employee must be satisfactory to the Engineer.

The Design-Build Team shall submit a safety plan and designate an employee as Safety Supervisor.

Both plans shall be submitted at the preconstruction conference and must be satisfactory to the Engineer. Should the design plan include activities that would place personnel on the work site, traffic control and safety plans for those activities shall be submitted at the predesign conference.

During the preconstruction conference, the Engineer will designate a Department employee or employees who will be responsible to see that the traffic control plans and any alterations thereto are implemented and monitored to the end that traffic is carried through the work in an effective manner. If approved by the Engineer, the Design-Build Team may designate one employee to be responsible for both the traffic control and safety plans. The Design-Build Team shall not designate its superintendent as the responsible person for either the traffic control plan or the safety plan, unless approved by the Engineer.

If the project requires that Design-Build Team or State personnel work from falsework, within shoring, or in any other hazardous area the Design-Build Team shall submit, as part of the Design-Build Team's safety plan, specific measures it will use to ensure worker safety.

The Design-Build Team shall also submit a program for erosion control and pollution prevention on all projects involving clearing and grubbing, earthwork, structural work, or other construction, when such work is likely to create erosion or pollution problems.

If the Design-Build Team fails to provide the required submissions, the Engineer may order the preconstruction conference suspended until such time as they are furnished. Work shall not begin until the preconstruction conference has been concluded and the safety plan has been approved, unless authorized by the Engineer. The Design-Build Team shall not be entitled to additional compensation or an extension of contract time resulting from any delays due to such a suspension.

The Design-Build Team shall designate a qualified employee as Quality Control Manager. The Quality Control Manager shall be responsible for implementing and monitoring the quality control requirements of the project.

Page 1-65, Article 108-4, add the following sentence to the end of this article:

The Design-Build Team shall record the proceedings of these conferences and distribute the final minutes of the conferences to all attendees.

Page 1-65, Article 108-5, delete the first sentence of the second paragraph and delete the first word of the second sentence of the second paragraph.

Page 1-66, Article 108-6, replace “40%” with “30%” in the 1st paragraph.

Page 1-66, Article 108-6, replace “35%” with “25%” in the 2nd paragraph.

Pages 1-68, delete Article 108-8 and replace with the following:

108-8 FAILURE TO MAINTAIN SATISFACTORY PROGRESS

The Engineer will check the Design-Build Team's progress at the time each partial pay request is received. The Design-Build Team's progress may be considered as unsatisfactory if, according to the Progress schedule, the projected finish date for all work exceeds the scheduled finish date by more than 10%.

When the Design-Build Team's progress is found to be unsatisfactory as described above, the Engineer may make written demand of the Design-Build Team to state in writing the reason for the unsatisfactory progress and produce such supporting data as the Engineer may require or the Design-Build Team may desire to submit. The Engineer will consider the justifications submitted by the Design-Build Team and extensions of the completion date that have or may be allowed in accordance with Article 108-10(B) and as modified herein.

When the Design-Build Team cannot satisfactorily justify the unsatisfactory progress the Engineer may invoke one or more of the following sanctions:

1. Withhold anticipated liquidated damages from amounts currently due or which become due.
2. Remove the Design-Build Team and individual managing firms of the Design-Build Team and/or prequalified design firms from the Department's Prequalified Bidders List.

When any of the above sanctions have been invoked, they shall remain in effect until rescinded by the Engineer.

Page 1-71, Article 108-10(B), add the following as the first paragraph:

Only delays to activities which affect the completion date or intermediate contract date will be considered for an extension of contract time. No extensions will be granted until a delay occurs which impacts the project's critical path and extends the work beyond the contract completion date or intermediate completion date. Any extension to the completion date or intermediate contract date will be based on the number of calendar days the completion date or intermediate completion date is impacted as determined by the Engineer's analysis.

Pages 1-71, delete Subarticle 108-10(B)(1) in its entirety.

Page 1-75, Article 108-13, delete bullet (E)(2) in its entirety.

**SECTION 109
MEASUREMENT AND PAYMENT**

Page 1-76, Article 109-2, delete the last sentence of the 1st paragraph and replace with the following:

Payment to the Design-Build Team will be made only for the work completed, certified and accepted in accordance with the terms of the contract.

Pages 1-81, delete Article 109-4(A) and replace with the following:

109-4 PARTIAL PAYMENTS

(A) General:

Partial payments will be based upon progress estimates prepared by the Engineer at least once each month on the date established by the Engineer. Partial payments may be made twice each month if in the judgment of the Engineer the amount of work performed is sufficient to warrant such payment. No partial payment will be made when the total value of work performed since the last partial payment amounts to less than \$10,000.00. Partial payments will be approximate only and will be subject to correction in the final estimate and payment.

When the contract includes one lump sum price for the entire work required by the contract, partial payments for the lump sum design-build price shall be based on a certified Schedule of Values submitted by the successful Design-Build Team and approved by the Engineer. The certification shall indicate the Design-Build Team has reviewed the information submitted and the information accurately represents the work performed for which payment is requested. The certified Schedule of Values shall be submitted no later than 30 calendar days after the date of award. Each item on the certified Schedule of Values shall be assigned a cost and quantity and shall be identified as an activity on the progress schedule. A revised certified Schedule of Values shall be submitted with each update of the Progress schedule as described in Article 108-2, and as modified herein, or when requested by the Engineer. A certified copy of the Table of Quantities shall also be submitted with each payment request. The certification of the Table of Quantities shall indicate the Design-Build Team has reviewed the information submitted and the information accurately represents the materials for the work performed for which payment is requested.

When the contract includes lump sum items for portions of the work required by the contract, and the applicable section of the Specifications or Request for Proposals specify the means by which the total amount bid be included in the partial pay estimates, the Engineer will determine amounts due on the partial pay estimate in accordance with the applicable portion of the Specifications or Request for Proposals.

The Engineer will withhold an amount sufficient to cover anticipated liquidated damages as determined by the Engineer.

Page 1-82, Subarticle 109-5(D), delete the 4th and 5th paragraphs and replace with the following:

Partial payments will not be made on seed or any living or perishable plant materials.

Partial payment requests shall not be submitted by the Design-Build Team until those items requested have corresponding signed and sealed RFC plans accepted by the Department.

Pages 1-84, Article 109-10, add the following as bullets (E) and (F) under the 1st paragraph.

- (E)** Other submittals, as required by the Request for Proposals. If the Design-Build Team is performing Construction Engineering and Inspection services, As-Constructed Drawings.
- (F)** Documents or guarantees to support any warranty provided by the Design Build Team.

County : Guilford

Line #	Item Number	Sec #	Description	Quantity	Unit Cost	Amount
ROADWAY ITEMS						
0001	0000900000-N	SP	GENERIC MISCELLANEOUS ITEM DESIGN AND CONSTRUCTION I-5110	Lump Sum	L.S.	
0002	0000900000-N	SP	GENERIC MISCELLANEOUS ITEM DESIGN AND CONSTRUCTION R-2413A & R-2413B	Lump Sum	L.S.	
0003	0000900000-N	SP	GENERIC MISCELLANEOUS ITEM DESIGN AND CONSTRUCTION TAXIWAY BRIDGE	Lump Sum	L.S.	
0945/Jul31/Q3.0/D2700000/E3			Total Amount Of Bid For Entire Project :			

Addendum No. 1, January 14, 2014

C 203433 (I-5110, R-2413A & R-2413B)

Fuel Usage Factor Chart and Estimate of Quantities

Guilford County

FUEL USAGE FACTOR CHART AND ESTIMATE OF QUANTITIES FOR I-5110

Description of Work	Units	Fuel Usage Factor Diesel #2	Estimate of Quantities
Unclassified Excavation	Gal / CY	0.29	_____ CY
Borrow Excavation	Gal / CY	0.29	_____ CY
Class IV Subgrade Stabilization Aggregate Base Course Aggregate for Cement Treated Base Course Portland Cement for Cement Treated Base Course	Gal / Ton	0.55	_____ Tons
Asphalt Concrete Base Course Asphalt Concrete Intermediate Course Asphalt Concrete Surface Course Permeable Asphalt Drainage Course Open-Graded Asphalt Friction Course Sand Asphalt Surface Course, Type F-1	Gal / Ton	2.90	_____ Tons
Portland Cement Concrete Pavement Concrete Shoulders Adjacent to Pavement	Gal / CY	0.98	_____ CY
Structural Concrete (Cast-in-Place Only)	Gal / CY	0.98	_____ CY

The above quantities represent a reasonable estimate of the total quantities anticipated, for each item, as pertaining to fuel price adjustments, and is representative of the design proposed in the Technical Proposal submitted under separate cover.

Or

The Design-Build Team elects not to pursue reimbursement for Fuel Price Adjustments on this project.

The information submitted on this sheet is claimed as a "Trade Secret" in accordance with the requirements of G.S. 66-152(3) until such time as the Price Proposal is opened.

Signature, Title

Dated

Print Name, Title

(Submit a copy of this sheet in a separate sealed package with the outer wrapping clearly marked "Fuel Price Adjustment" and deliver with the Technical and Price Proposal.)

Addendum No. 1, January 14, 2014

C 203433 (I-5110, R-2413A & R-2413B) Fuel Usage Factor Chart and Estimate of Quantities Guilford County

FUEL USAGE FACTOR CHART AND ESTIMATE OF QUANTITIES FOR R-2413A&B

Description of Work	Units	Fuel Usage Factor Diesel #2	Estimate of Quantities
Unclassified Excavation	Gal / CY	0.29	_____ CY
Borrow Excavation	Gal / CY	0.29	_____ CY
Class IV Subgrade Stabilization Aggregate Base Course Aggregate for Cement Treated Base Course Portland Cement for Cement Treated Base Course	Gal / Ton	0.55	_____ Tons
Asphalt Concrete Base Course Asphalt Concrete Intermediate Course Asphalt Concrete Surface Course Permeable Asphalt Drainage Course Open-Graded Asphalt Friction Course Sand Asphalt Surface Course, Type F-1	Gal / Ton	2.90	_____ Tons
Portland Cement Concrete Pavement Concrete Shoulders Adjacent to Pavement	Gal / CY	0.98	_____ CY
Structural Concrete (Cast-in-Place Only)	Gal / CY	0.98	_____ CY

The above quantities represent a reasonable estimate of the total quantities anticipated, for each item, as pertaining to fuel price adjustments, and is representative of the design proposed in the Technical Proposal submitted under separate cover.

Or

The Design-Build Team elects not to pursue reimbursement for Fuel Price Adjustments on this project.

The information submitted on this sheet is claimed as a "Trade Secret" in accordance with the requirements of G.S. 66-152(3) until such time as the Price Proposal is opened.

Signature, Title

Dated

Print Name, Title

(Submit a copy of this sheet in a separate sealed package with the outer wrapping clearly marked "Fuel Price Adjustment" and deliver with the Technical and Price Proposal.)

FUEL USAGE FACTOR CHART AND ESTIMATE OF QUANTITIES
FOR TAXIWAY BRIDGE

Description of Work	Units	Fuel Usage Factor Diesel #2	Estimate of Quantities
Unclassified Excavation	Gal / CY	0.29	_____ CY
Borrow Excavation	Gal / CY	0.29	_____ CY
Structural Concrete (Cast-in-Place Only)	Gal / CY	0.98	_____ CY

The above quantities represent a reasonable estimate of the total quantities anticipated, for each item, as pertaining to fuel price adjustments, and is representative of the design proposed in the Technical Proposal submitted under separate cover.

Or

The Design-Build Team elects not to pursue reimbursement for Fuel Price Adjustments on this project.

The information submitted on this sheet is claimed as a “Trade Secret” in accordance with the requirements of G.S. 66-152(3) until such time as the Price Proposal is opened.

Signature, Title

Dated

Print Name, Title

(Submit a copy of this sheet in a separate sealed package with the outer wrapping clearly marked “Fuel Price Adjustment” and deliver with the Technical and Price Proposal.)

LISTING OF DBE SUBCONTRACTORS				Sheet _____	of _____
Firm Name and Address	Item No.	Item Description	* Agreed upon Unit Price	** Dollar Volume of Item	
Name Address					
Name Address					
Name Address					
Name Address					
Name Address					
Name Address					
Name Address					

This form must be completed in order for the Bid to be considered responsive and be publicly read. Bidders with no DBE participation must so indicate this on the form by entering the word or number *zero*.

LISTING OF DBE SUBCONTRACTORS				Sheet _____	of _____
Firm Name and Address	Item No.	Item Description	* Agreed upon Unit Price	** Dollar Volume of Item	
Name Address					
Name Address					
Name Address					
Name Address					
Name Address					
Name Address					
Name Address					

This form must be completed in order for the Bid to be considered responsive and be publicly read. Bidders with no DBE participation must so indicate this on the form by entering the word or number *zero*.

LISTING OF DBE SUBCONTRACTORS						
Firm Name and Address			Item No.	Item Description	* Agreed upon Unit Price	** Dollar Volume of Item
Name						
Address						
Name						
Address						
Name						
Address						
Name						
Address						
Name						
Address						
Name						
Address						

This form must be completed in order for the Bid to be considered responsive and be publicly read. Bidders with no DBE participation must so indicate this on the form by entering the word or number *zero*.

LISTING OF DBE SUBCONTRACTORS				
			Sheet _____	of _____
Firm Name and Address	Item No.	Item Description	* Agreed upon Unit Price	** Dollar Volume of Item
Name Address				
Name Address				
Name Address				
Name Address				

COST OF CONSTRUCTION WORK ONLY \$ _____

*The Dollar Volume shown in this column shall be the Actual Price Agreed Upon by the Prime Contractor and the DBE subcontractor, and these prices will be used to determine the percentage of the DBE participation in the contract.

** Dollar Volume of DBE Subcontractor \$ _____

Percentage of Total Construction Cost _____ %

(Including Right of Way Acquisition Services)

** - Must have entry even if figure to be entered is zero.

** - *If firm is a Material Supplier Only, show Dollar Volume as 60% of Agreed Upon Amount from Letter of Intent.
If firm is a Manufacturer, show Dollar Volume as 100% of Agreed Upon Amount from Letter of Intent.*

**This form must be completed in order for the Bid to be considered responsive and be publicly read.
Bidders with no DBE participation must so indicate this on the form by entering the word or number *zero*.**

**EXECUTION OF BID
NON-COLLUSION AFFIDAVIT, DEBARMENT CERTIFICATION AND GIFT BAN CERTIFICATION**

CORPORATION

The person executing the bid, on behalf of the Bidder, being duly sworn, solemnly swears (or affirms) that neither he, nor any official, agent or employee of the bidder has entered into any agreement, participated in any collusion, or otherwise taken any action which is in restraint of free competitive bidding in connection with any bid or contract, that the bidder has not been convicted of violating *N.C.G.S. § 133-24* within the last three years, and that the Bidder intends to do the work with its own bonafide employees or subcontractors and is not bidding for the benefit of another contractor.

In addition, execution of this bid in the proper manner also constitutes the Bidder's certification of status under penalty of perjury under the laws of the United States in accordance with the Debarment Certification attached, provided that the Debarment Certification also includes any required statements concerning exceptions that are applicable.

N.C.G.S. § 133-32 and Executive Order 24 prohibit the offer to, or acceptance by, any State Employee of any gift from anyone with a contract with the State, or from any person seeking to do business with the State. By execution of any response in this procurement, you attest, for your entire organization and its employees or agents, that you are not aware that any such gift has been offered, accepted, or promised by any employees of your organization.

SIGNATURE OF CONTRACTOR

Full name of Corporation

Address as prequalified

Attest _____
Secretary/Assistant Secretary
Select appropriate title

By _____
President/Vice President/Assistant Vice President
Select appropriate title

Print or type Signer's name

Print or type Signer's name

CORPORATE SEAL

AFFIDAVIT MUST BE NOTARIZED

Subscribed and sworn to before me this the _____ day of _____, 20____

Signature of Notary Public
Of _____ County
State of _____
My Commission Expires _____

NOTARY SEAL

**EXECUTION OF BID
NON-COLLUSION AFFIDAVIT, DEBARMENT CERTIFICATION AND GIFT BAN CERTIFICATION**

PARTNERSHIP

The person executing the bid, on behalf of the Bidder, being duly sworn, solemnly swears (or affirms) that neither he, nor any official, agent or employee of the bidder has entered into any agreement, participated in any collusion, or otherwise taken any action which is in restraint of free competitive bidding in connection with any bid or contract, that the bidder has not been convicted of violating *N.C.G.S. § 133-24* within the last three years, and that the Bidder intends to do the work with its own bonafide employees or subcontractors and is not bidding for the benefit of another contractor.

In addition, execution of this bid in the proper manner also constitutes the Bidder's certification of status under penalty of perjury under the laws of the United States in accordance with the Debarment Certification attached, provided that the Debarment Certification also includes any required statements concerning exceptions that are applicable.

N.C.G.S. § 133-32 and Executive Order 24 prohibit the offer to, or acceptance by, any State Employee of any gift from anyone with a contract with the State, or from any person seeking to do business with the State. By execution of any response in this procurement, you attest, for your entire organization and its employees or agents, that you are not aware that any such gift has been offered, accepted, or promised by any employees of your organization.

SIGNATURE OF CONTRACTOR

_____ Full Name of Partnership

_____ Address as Prequalified

_____ By _____
Signature of Witness Signature of Partner

_____ Print or type Signer's name _____ Print or type Signer's name

AFFIDAVIT MUST BE NOTARIZED

Subscribed and sworn to before me this the
day of _____ 20____.

_____ Signature of Notary Public

of _____ County
State of _____
My Commission Expires: _____

NOTARY SEAL

**EXECUTION OF BID
NON-COLLUSION AFFIDAVIT, DEBARMENT CERTIFICATION AND GIFT BAN CERTIFICATION
LIMITED LIABILITY COMPANY**

The person executing the bid, on behalf of the Bidder, being duly sworn, solemnly swears (or affirms) that neither he, nor any official, agent or employee of the bidder has entered into any agreement, participated in any collusion, or otherwise taken any action which is in restraint of free competitive bidding in connection with any bid or contract, that the bidder has not been convicted of violating *N.C.G.S. § 133-24* within the last three years, and that the Bidder intends to do the work with its own bonafide employees or subcontractors and is not bidding for the benefit of another contractor.

In addition, execution of this bid in the proper manner also constitutes the Bidder's certification of status under penalty of perjury under the laws of the United States in accordance with the Debarment Certification attached, provided that the Debarment Certification also includes any required statements concerning exceptions that are applicable.

N.C.G.S. § 133-32 and Executive Order 24 prohibit the offer to, or acceptance by, any State Employee of any gift from anyone with a contract with the State, or from any person seeking to do business with the State. By execution of any response in this procurement, you attest, for your entire organization and its employees or agents, that you are not aware that any such gift has been offered, accepted, or promised by any employees of your organization.

SIGNATURE OF CONTRACTOR

Full Name of Firm

Address as Prequalified

Signature of Witness

Signature of Member/Manager/Authorized Agent
Select appropriate title

Print or type Signer's name

Print or type Signer's Name

AFFIDAVIT MUST BE NOTARIZED

Subscribed and sworn to before me this the _____
_____ day of _____ 20__.

NOTARY SEAL

Signature of Notary Public

of _____ County

State of _____

My Commission Expires: _____

EXECUTION OF BID
NON-COLLUSION AFFIDAVIT, DEBARMENT CERTIFICATION AND GIFT BAN CERTIFICATION
JOINT VENTURE (2) or (3)

The person executing the bid, on behalf of the Bidder, being duly sworn, solemnly swears (or affirms) that neither he, nor any official, agent or employee of the bidder has entered into any agreement, participated in any collusion, or otherwise taken any action which is in restraint of free competitive bidding in connection with any bid or contract, that the bidder has not been convicted of violating N.C.G.S. § 133-24 within the last three years, and that the Bidder intends to do the work with its own bonafide employees or subcontractors and is not bidding for the benefit of another contractor.

In addition, execution of this bid in the proper manner also constitutes the Bidder's certification of status under penalty of perjury under the laws of the United States in accordance with the Debarment Certification attached, provided that the Debarment Certification also includes any required statements concerning exceptions that are applicable.

N.C.G.S. § 133-32 and Executive Order 24 prohibit the offer to, or acceptance by, any State Employee of any gift from anyone with a contract with the State, or from any person seeking to do business with the State. By execution of any response in this procurement, you attest, for your entire organization and its employees or agents, that you are not aware that any such gift has been offered, accepted, or promised by any employees of your organization.

SIGNATURE OF CONTRACTORS

Instructions: 2 Joint Venturers Fill in lines (1), (2) and (3) and execute. 3 Joint Venturers Fill in lines (1), (2), (3) and (4) and execute. On Line (1), fill in the name of the Joint Venture Company. On Line (2), fill in the name of one of the joint venturers and execute below in the appropriate manner. On Line (3), print or type the name of the other joint venturer and execute below in the appropriate manner. On Line (4), fill in the name of the third joint venturer, if applicable and execute below in the appropriate manner.

(1) Name of Joint Venture

(2) Name of Contractor

Address as prequalified

Signature of Witness or Attest By Signature of Contractor

Print or type Signer's name Print or type Signer's name

If Corporation, affix Corporate Seal and

(3) Name of Contractor

Address as prequalified

Signature of Witness or Attest By Signature of Contractor

Print or type Signer's name Print or type Signer's name

If Corporation, affix Corporate Seal and

(4) Name of Contractor (for 3 Joint Venture only)

Address as prequalified

Signature of Witness or Attest By Signature of Contractor

Print or type Signer's name Print or type Signer's name

If Corporation, affix Corporate Seal

NOTARY SEAL
Affidavit must be notarized for Line (2)
Subscribed and sworn to before me this
day of 20

Signature of Notary Public
of County
State of
My Commission Expires:

NOTARY SEAL
Affidavit must be notarized for Line (3)
Subscribed and sworn to before me this
day of 20

Signature of Notary Public
of County
State of
My Commission Expires:

NOTARY SEAL
Affidavit must be notarized for Line (4)
Subscribed and sworn to before me this
day of 20

Signature of Notary Public
of County
State of
My Commission Expires:

**EXECUTION OF BID
NON-COLLUSION AFFIDAVIT, DEBARMENT CERTIFICATION AND GIFT BAN CERTIFICATION**

INDIVIDUAL DOING BUSINESS UNDER A FIRM NAME

The person executing the bid, on behalf of the Bidder, being duly sworn, solemnly swears (or affirms) that neither he, nor any official, agent or employee of the bidder has entered into any agreement, participated in any collusion, or otherwise taken any action which is in restraint of free competitive bidding in connection with any bid or contract, that the bidder has not been convicted of violating *N.C.G.S. § 133-24* within the last three years, and that the Bidder intends to do the work with its own bonafide employees or subcontractors and is not bidding for the benefit of another contractor.

In addition, execution of this bid in the proper manner also constitutes the Bidder's certification of status under penalty of perjury under the laws of the United States in accordance with the Debarment Certification attached, provided that the Debarment Certification also includes any required statements concerning exceptions that are applicable.

N.C.G.S. § 133-32 and Executive Order 24 prohibit the offer to, or acceptance by, any State Employee of any gift from anyone with a contract with the State, or from any person seeking to do business with the State. By execution of any response in this procurement, you attest, for your entire organization and its employees or agents, that you are not aware that any such gift has been offered, accepted, or promised by any employees of your organization.

SIGNATURE OF CONTRACTOR

Name of Contractor

_____ Individual name

Trading and doing business as

_____ Full name of Firm

_____ Address as Prequalified

_____ Signature of Witness

_____ Signature of Contractor, Individually

_____ Print or type Signer's name

_____ Print or type Signer's name

AFFIDAVIT MUST BE NOTARIZED

Subscribed and sworn to before me this the
_____ day of _____ 20__.

_____ Signature of Notary Public
of _____ County
State of _____
My Commission Expires: _____

NOTARY SEAL

**EXECUTION OF BID
NON-COLLUSION AFFIDAVIT, DEBARMENT CERTIFICATION AND GIFT BAN CERTIFICATION**

INDIVIDUAL DOING BUSINESS IN HIS OWN NAME

The person executing the bid, on behalf of the Bidder, being duly sworn, solemnly swears (or affirms) that neither he, nor any official, agent or employee of the bidder has entered into any agreement, participated in any collusion, or otherwise taken any action which is in restraint of free competitive bidding in connection with any bid or contract, that the bidder has not been convicted of violating *N.C.G.S. § 133-24* within the last three years, and that the Bidder intends to do the work with its own bonafide employees or subcontractors and is not bidding for the benefit of another contractor.

In addition, execution of this bid in the proper manner also constitutes the Bidder's certification of status under penalty of perjury under the laws of the United States in accordance with the Debarment Certification attached, provided that the Debarment Certification also includes any required statements concerning exceptions that are applicable.

N.C.G.S. § 133-32 and Executive Order 24 prohibit the offer to, or acceptance by, any State Employee of any gift from anyone with a contract with the State, or from any person seeking to do business with the State. By execution of any response in this procurement, you attest, for your entire organization and its employees or agents, that you are not aware that any such gift has been offered, accepted, or promised by any employees of your organization.

SIGNATURE OF CONTRACTOR

Name of Contractor _____
Print or type Individual name

Address as Prequalified

Signature of Contractor, Individually

Print or type Signer's Name

Signature of Witness

Print or type Signer's name

AFFIDAVIT MUST BE NOTARIZED

Subscribed and sworn to before me this the
_____ day of _____ 20__.

Signature of Notary Public
of _____ County
State of _____
My Commission Expires: _____

NOTARY SEAL

DEBARMENT CERTIFICATION

Conditions for certification:

1. The prequalified bidder shall provide immediate written notice to the Department if at any time the bidder learns that his certification was erroneous when he submitted his debarment certification or explanation that is file with the Department, or has become erroneous because of changed circumstances.
2. The terms *covered transaction, debarred, suspended, ineligible, lower tier covered transaction, participant, person, primary covered transaction, principal, proposal, and voluntarily excluded*, as used in this provision, have the meanings set out in the Definitions and Coverage sections of the rules implementing Executive Order 12549. A copy of the Federal Rules requiring this certification and detailing the definitions and coverages may be obtained from the Contract Officer of the Department.
3. The prequalified bidder agrees by submitting this form, that he will not knowingly enter into any lower tier covered transaction with a person who is debarred, suspended, declared ineligible, or voluntarily excluded from participation in NCDOT contracts, unless authorized by the Department.
4. For Federal Aid projects, the prequalified bidder further agrees that by submitting this form he will include the Federal-Aid Provision titled *Required Contract Provisions Federal-Aid Construction Contract (Form FHWA PR 1273)* provided by the Department, without subsequent modification, in all lower tier covered transactions.
5. The prequalified bidder may rely upon a certification of a participant in a lower tier covered transaction that he is not debarred, suspended, ineligible, or voluntarily excluded from the covered transaction, unless he knows that the certification is erroneous. The bidder may decide the method and frequency by which he will determine the eligibility of his subcontractors.
6. Nothing contained in the foregoing shall be construed to require establishment of a system of records in order to render in good faith the certification required by this provision. The knowledge and information of a participant is not required to exceed that which is normally possessed by a prudent person in the ordinary course of business dealings.
7. Except as authorized in paragraph 6 herein, the Department may terminate any contract if the bidder knowingly enters into a lower tier covered transaction with a person who is suspended, debarred, ineligible, or voluntarily excluded from participation in this transaction, in addition to other remedies available by the Federal Government.

DEBARMENT CERTIFICATION

The prequalified bidder certifies to the best of his knowledge and belief, that he and his principals:

- a. Are not presently debarred, suspended, proposed for debarment, declared ineligible, or voluntarily excluded from covered transactions by any Federal department or agency;
- b. Have not within a three-year period preceding this proposal been convicted of or had a civil judgment rendered against them for commission of fraud or a criminal offense in connection with obtaining, attempting to obtain, or performing a public (Federal, State or local) transaction or contract under a public transaction; violation of Federal or State antitrust statutes or commission of embezzlement, theft, forgery, bribery, falsification or destruction of records; making false statements; or receiving stolen property;
- c. Are not presently indicted for or otherwise criminally or civilly charged by a governmental entity (Federal, State or local) with commission of any of the offenses enumerated in paragraph b. of this certification; and
- d. Have not within a three-year period preceding this proposal had one or more public transactions (Federal, State or local) terminated for cause or default.
- e. Will submit a revised Debarment Certification immediately if his status changes and will show in his bid proposal an explanation for the change in status.

If the prequalified bidder cannot certify that he is not debarred, he shall provide an explanation with this submittal. An explanation will not necessarily result in denial of participation in a contract.

Failure to submit a non-collusion affidavit and debarment certification will result in the prequalified bidder's bid being considered non-responsive.

Check here if an explanation is attached to this certification.

Contract No.: C 203433

County: Guilford

ACCEPTED BY THE
DEPARTMENT OF TRANSPORTATION

Contract Officer

Date

Execution of Contract and Bonds
Approved as to Form:

Attorney General